

# Printing and paper

be in motion

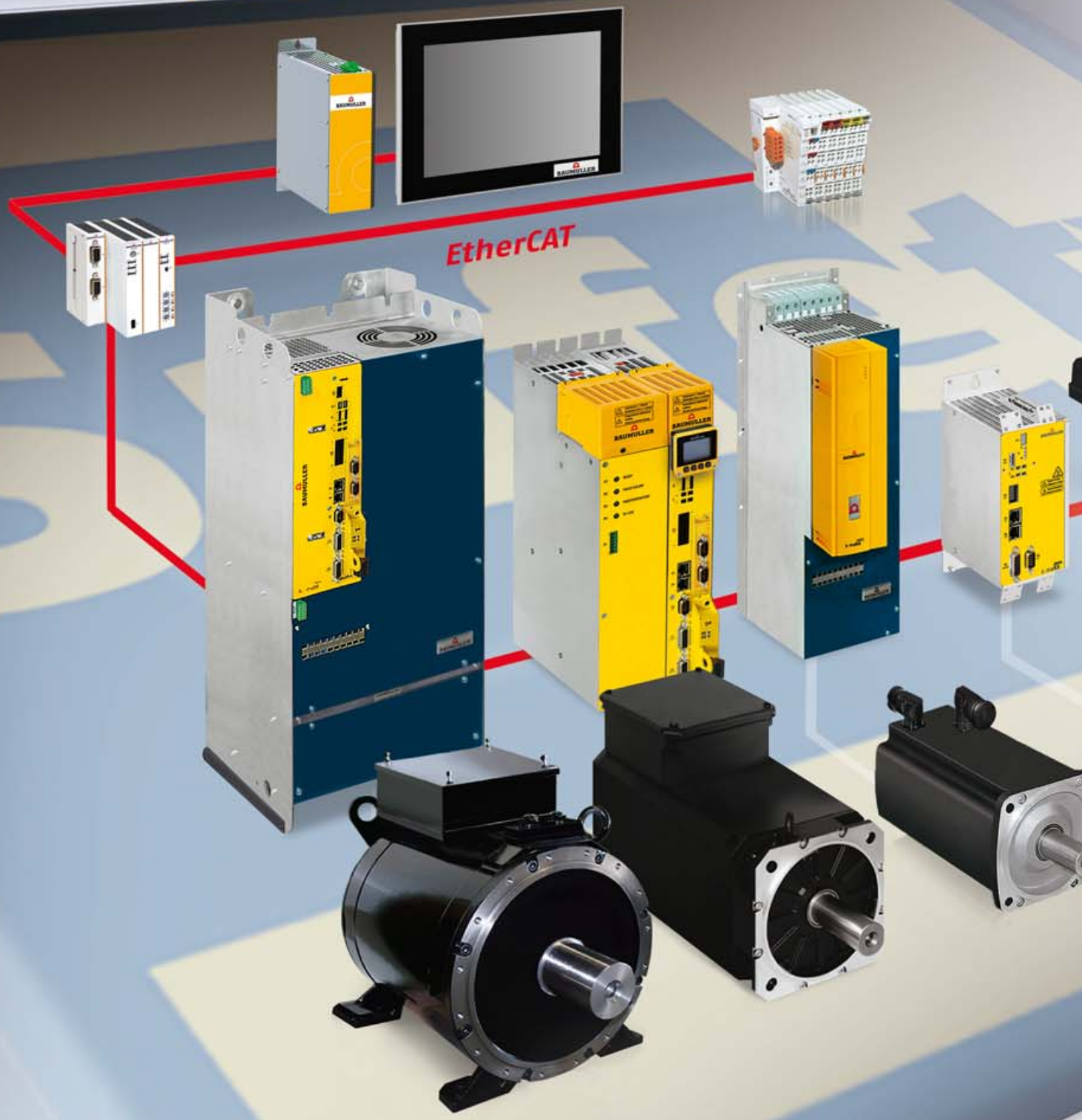



## Baumüller – your competent partner for the printing and paper industry

### From the components to the complete installation

For many years Baumüller is the leading company in automation and drive systems for printing machines, from sheet-fed printing to label printing up to newspaper printing. Thereby, Baumüller is not active in the actual printing process only but also in the preparatory and post-processing stage. Long years of collaboration with the machine manufacturers has allowed Baumüller to provide all sectors of the printing industry with innovative and optimized drive solutions for your competitive advantage.

For us global service is a matter of fact. With over 40 subsidiaries worldwide Baumüller is always close and it doesn't matter where your machine is installed. Maintenance and service logistics are always on-site. We cover all the lifecycle phases of your system – from the predictive maintenance and repair to the improvement.

Make the most of the flexibility and innovation that our experts at Baumüller offer for customizing automation and drive concepts to meet your requirements.

[www.baumueller.de](http://www.baumueller.de)

<b>5</b>	<b>Baumüller Lifecycle Management</b>
<b>6</b>	<b>Print unit – Direct drive technology</b>
<b>8</b>	<b>Feeding and stacking – Format flexibility</b>
<b>10</b>	<b>Envelope machine – Configuration management</b>
<b>12</b>	<b>System engineering</b>
<b>14</b>	<b>Mounting, commissioning and system service</b>
<b>16</b>	<b>System service, maintenance and retrofitting</b>
<b>18</b>	<b>ProMaster Engineering Framework</b>
<b>20</b>	<b>Converters</b>
<b>22</b>	<b>Motors</b>



### **Efficient and future-proof**

The printing sector is reinventing itself. As a long-standing technology partner of the leading machine manufacturers in the printing and paper industry we help shape the process of change active. For decades Baumüller develops, plans and produces drive and automation systems for the printing and paper industry in cooperation with the customers.

The reliability, robust design and high availability of our automation systems make us your competent partner for your printing machines.

**Sheet fed printing**  
**Label printing**  
**Form printing**  
**Flexo printing**  
**Digital printing**  
**Commercial printing**  
**Newspaper printing**  
**Post processing**  
**Inline finishing**

# Baumüller Lifecycle Management

Worldwide and throughout the entire lifecycle of your machines and installations you can count on the competent and flexible support of our specialists: From the concept and implementation of optimally customized automation and drive systems to the installation and commissioning as well as the repair, preventive maintenance up to the machine mounting and relocation we cover all service areas.

As a customer-oriented technical contractor Baumüller provides the integration of the complete drive and control engineering into an open and flexible system.

## Your advantage

- ⊙ Modular flexible, at all times convertible and expandable machine concepts
- ⊙ Increase process quality due to highest precision and advanced real time fieldbus systems
- ⊙ Considerable reduction of energy costs due to the use of direct drive engineering as well as energy-efficient system solutions
- ⊙ Increased availability of the machine due to low-maintenance drive elements
- ⊙ Increased production safety due to the use of the remote maintenance system BAUDIS
- ⊙ Comprehensive range of services throughout the entire lifecycle of your machines and installations due to sustainable installation services
- ⊙ Global presence and a 24/7 service hotline

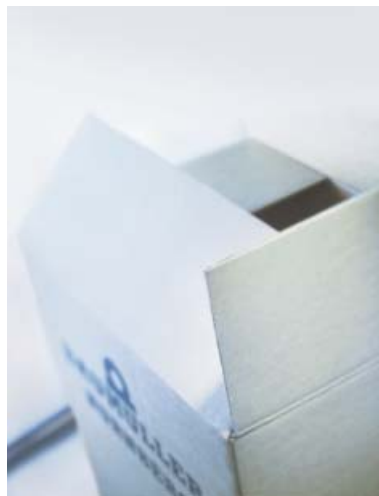

# Print unit – Direct drive technology

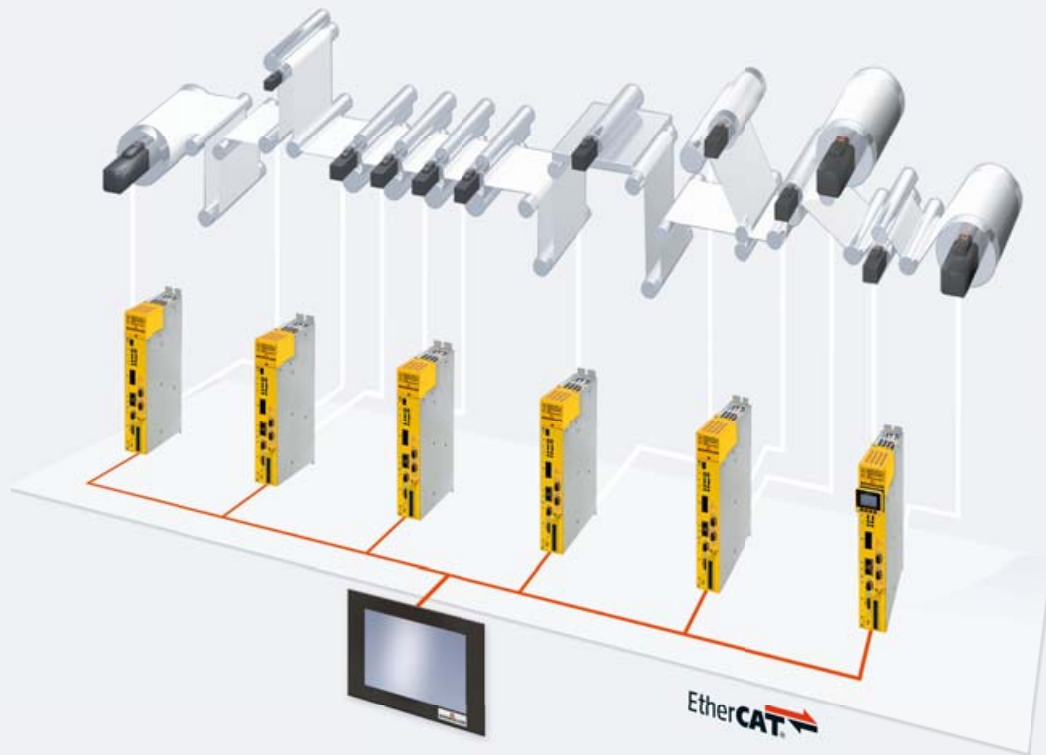

To provide flexibility and optimizations of the setup time, more and more direct drives are being used in printing machines. This is independent of sheet-fed or reel-fed machines, which have to adapt to increasing demands whose system limits continue to increase: For example, more than 20,000 sheets per hour or more than 70,000 pages per hour in reel-fed printing. Baumüller made single-drive technology in printing applications into standard business in various areas early on. Because of the special design of our motors, we can reduce the number of mechanical components on the axes and even do without the need for gears.

## Characteristics

- ⊙ Variable processing speed
- ⊙ Defined belt tension or sheet position
- ⊙ Coupling of additional machine modules possible
- ⊙ Can be implemented as a standalone module
- ⊙ Limited number of parameters
- ⊙ Highly dynamic compensating motions and cams
- ⊙ Synchronous motions (for example, back-step sequence or continuous transport)
- ⊙ Control panel

## Customer benefits

- ⊙ Less vibration, smooth machine motion protects the machine's mechanical components
- ⊙ Speed optimization, quality optimization means less paper waste
- ⊙ Can be integrated into your system via field bus or, for retrofits, through real master axis function
- ⊙ Registration controlled operation
- ⊙ Format flexibility
- ⊙ Fast commissioning, easy changeover
- ⊙ Access to all parameters, record up and down load easy operation and parameter setting, no laptop or software needed during servicing

## Your benefits – DST – Direct, accurate and flexible

High-torque synchronous motors for applications with the most extreme torque requirements, even with axial loads.

- ⊙ One engineering template for your system assembled from our standard software blocks
- ⊙ Scalable in functional scope and drive power
- ⊙ One customized solution from a combination of standard solutions

### For the following functions

- ⊙ Infeed and outfeed
- ⊙ Synchronization
- ⊙ Compensating motions
- ⊙ Registration control and monitoring
- ⊙ Belt tension control
- ⊙ Winding and unwinding

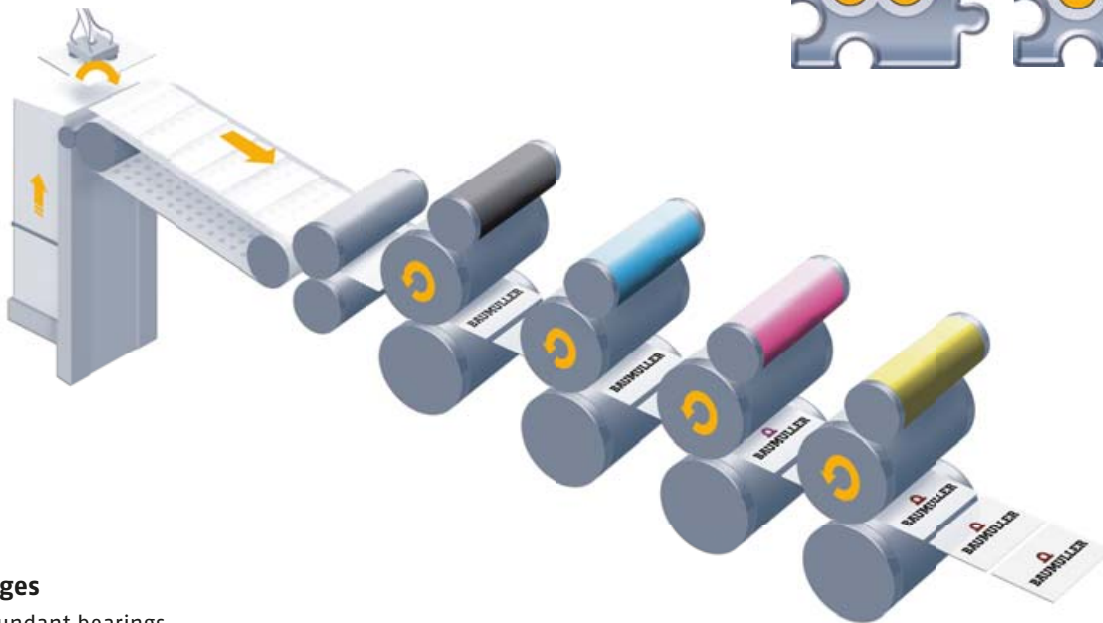
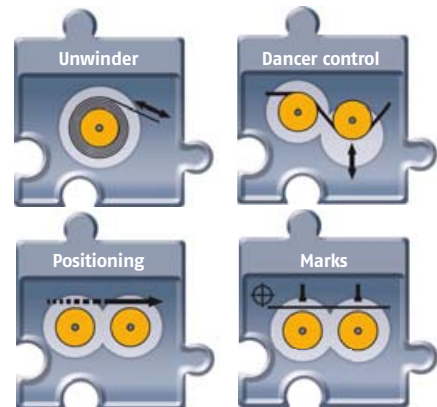

### Advantages

- ⊙ No redundant bearings
- ⊙ Frame length is minimized
- ⊙ No wearing parts
- ⊙ Axial rotor movement possible

### Differences compared to the complete motor

- ⊙ Final assembly at customer's facility
- ⊙ IP00 degree of protection
- ⊙ Encoder mounting and bearing on load side

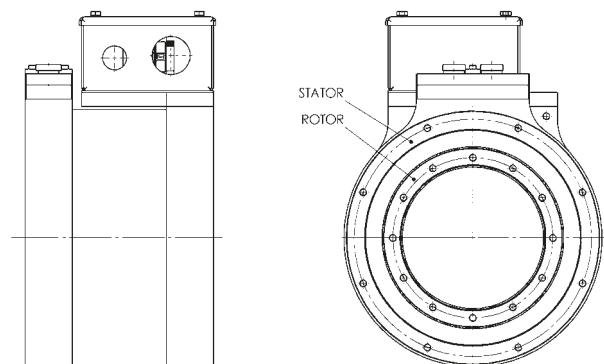

## Feeding and stacking – Format flexibility

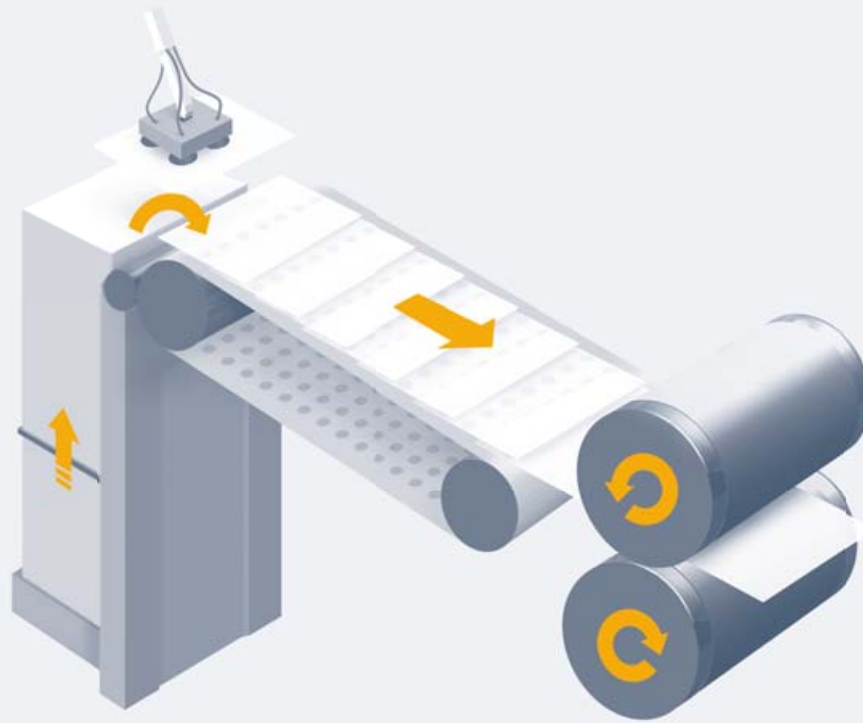

In sheet paper processing, whether this involves printing or other processing steps, the precise material flow becomes even more important at higher speeds. Baumüller supports the upper limits, for example, of up to 20,000 sheets per hour with the required dynamic and software functions. If your demands to the material to be processed should ever change, the transition can be completed quickly and smoothly.

### Characteristics

- ⦿ Variable processing speed
- ⦿ Defined sheet position
- ⦿ Acceleration, stack overlap, and separation can be adjusted individually
- ⦿ Coupling of additional machine modules is possible
- ⦿ Can be implemented as standalone module
- ⦿ Provides highly dynamic compensating motions
- ⦿ Includes sheet feeding with registration control

### Customer benefits

- ⦿ Gripper optimization regardless of main machine speed
- ⦿ Smooth machine motion protects the machine's mechanical components
- ⦿ Speed and quality optimization creates less wastepaper
- ⦿ Can be integrated into your system via field bus or, for retrofits, through real master axis function
- ⦿ Fast commissioning, easy changeover
- ⦿ Integration of additional functions into the motion sequence
- ⦿ Format and material independence



## Your benefits – Format flexibility

You have built your system based on a modular concept. In doing so, you have combined new machines from our function blocks and are now focusing on project specific requirements. Feeding and stacking are synchronized to your downstream stations, giving you the flexibility you need to handle different formats.

### Advantages

- ⊙ Scalable in functional performance and drive power
- ⊙ Synchronized with downstream processes
- ⊙ Flexible handling of different formats

### For the following functions

- ⊙ Feeding
- ⊙ Alignment
- ⊙ Acceleration
- ⊙ Transfer
- ⊙ Overlap stacking and/or vertical stacking
- ⊙ Sheet deceleration
- ⊙ Stack lift drives

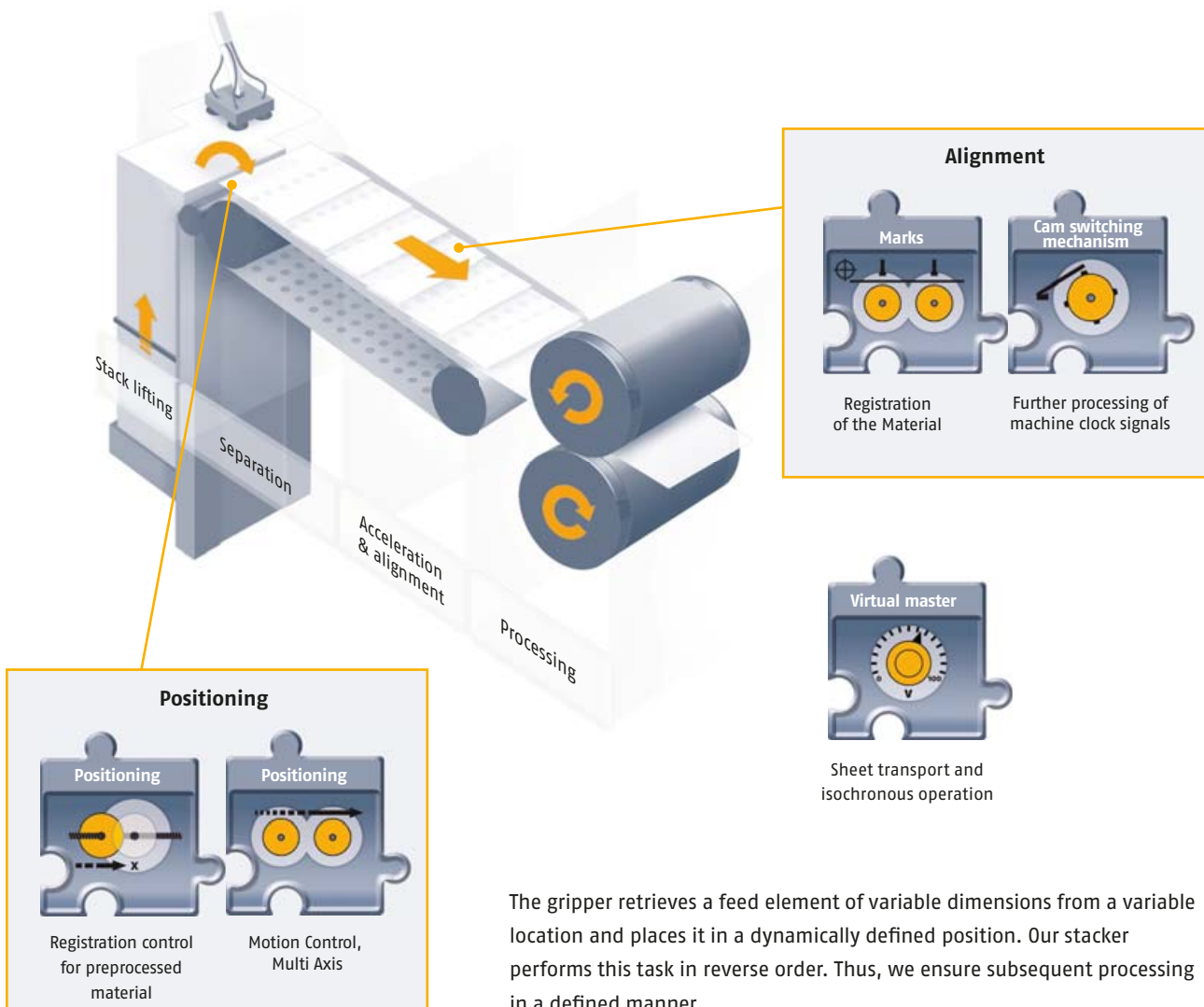

The gripper retrieves a feed element of variable dimensions from a variable location and places it in a dynamically defined position. Our stacker performs this task in reverse order. Thus, we ensure subsequent processing in a defined manner.

# Envelope machine – Configuration management

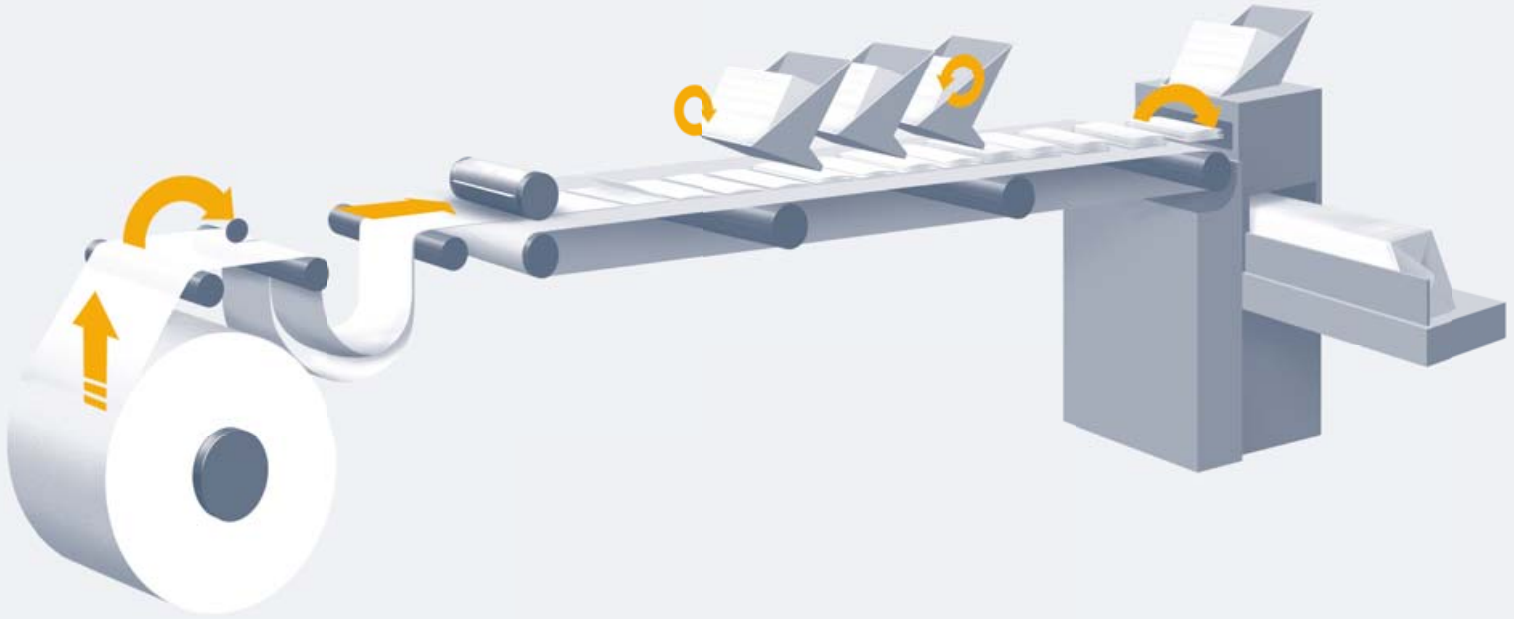

Personalization is becoming increasingly important in advanced production processes. In addition to the content, the format of the message is an important aspect. We use intelligent systems to ensure that machines are extremely flexible so that setup and job changeover times are minimized. With the help of Baumüller's engineering framework ProMaster you can finish the machine configuration, parameterization and programming in the shortest amount of time.

## Characteristics

- ⊙ Variable processing speeds
- ⊙ Defined cutting position
- ⊙ Electrically generated synchronized motion
- ⊙ Synchronization of additional modules
- ⊙ Taking advantage of reusable technology modules

## Customer benefits

- ⊙ Calculation of cam profiles independent of format and speed
- ⊙ Registration control
- ⊙ Incorporation of data matrix and barcode reader systems
- ⊙ Data matrix and barcode reader system monitoring
- ⊙ Reducing commissioning times and time to market

# Our control concepts for your automation

Advanced machines and systems are increasingly being built in a modular way whereat centralized, modular decentralized and hybrid automation concepts are provided. The request for more productivity and high availability leads to an increasing complexity of machines and systems.

## Engineering Framework ProMaster

Our consistent engineering framework ProMaster with integrated safety technology and complexity-reduced motion control technology is the perfect base for reduced complexity. It includes all specialties of an automation task: from the drive dimensioning, programming of controls, fieldbus parameterization and up to visualization. This is valid during the whole lifecycle – during planning and commissioning as well as at maintenance. Now you can focus on your core competences on the task at hand and reduce the time required to create your machine software, while also significantly reducing the costs.

## ProSafety – Safety with ProMaster

The programming system ProSafety was developed together with its runtime environment accordant to the IEC 61508 requirements and covers the entire range of the safety functionalities up to the safety integrity level 3 (SIL 3). The safety operation of a machine can now be implemented due to Pro Safety with low efforts. An assistant now guides the user to a safe control program within few steps.

## Our library concept

Our libraries are consistent, continue to grow and build up on one another. Interfaces ease the combination of the different modules. Your acquired know how can be filed and managed in own libraries and can be used at any time. By the use of international standards (for example PLCopen Motion Control) and technology-specific extensions of Baumüller the maximum investment reliability is ensured.

## Your advantage

- ⊙ Investment reliability
- ⊙ Encapsulation of IP (intellectual property) due to customer-defined functional modules/libraries
- ⊙ Reduction of complexity
- ⊙ Quick and easy application due to technology modules
- ⊙ Maintainable, trainable and transparent due to the structure of the program, which is always the same and to the axis modules
- ⊙ Use of templates for program structure and axis modules

## Your advantage

- ⊙ Efficient engineering, reduced effort
- ⊙ More efficient, flexible usable automation solutions because of defined interfaces, modular machine architectures and optional extensions
- ⊙ More quicker system production by a complete engineering environment
- ⊙ Improved product quality and reduced probability of errors

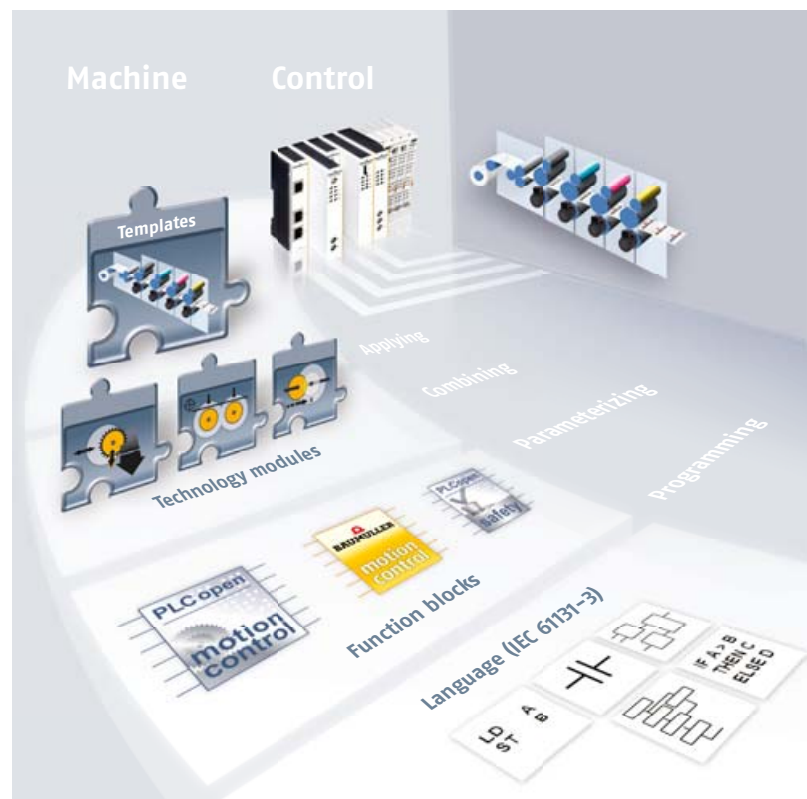

# System engineering

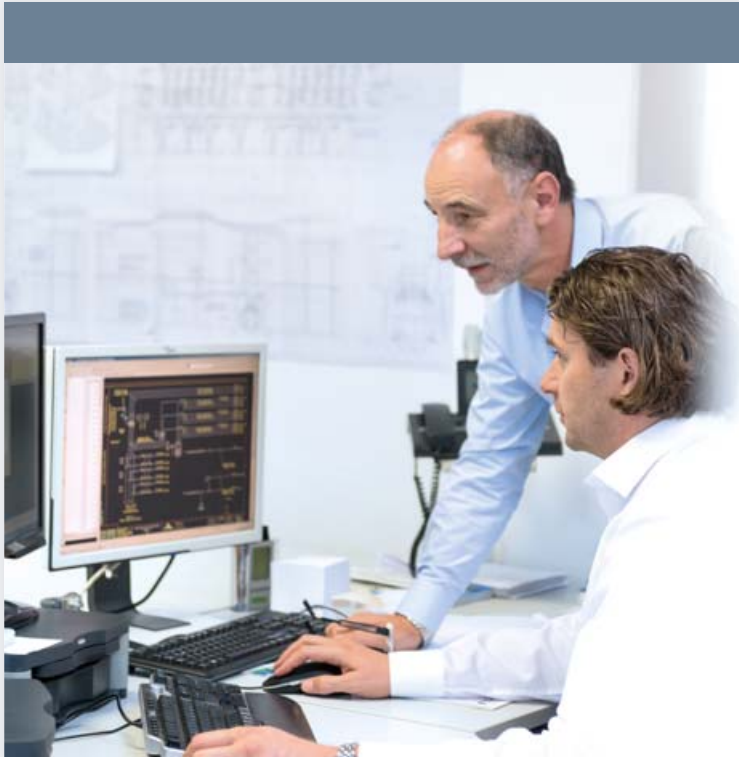

## Automation concept

- ⊙ Technical advice, process analysis and optimization
- ⊙ Development of production concepts
- ⊙ New concepts, retrofitting or upgrade
- ⊙ Project management
- ⊙ Complete automation
- ⊙ Customer-specific hardware planning



- ⊙ 24/7-Hotline
- ⊙ Remote diagnostics and remote maintenance
- ⊙ Service level agreements
- ⊙ Selected parts
- ⊙ Audits
- ⊙ Predictive maintenance
- ⊙ Condition monitoring
- ⊙ Maintenance, repair and servicing (manufacturer-independent)

## Service and improvement



## System engineering

- ⊙ Hardware construction (CAD electronics construction and circuit diagram creation, e.g. with EPLAN Electric P8, ELCAD and RUPLAN)
- ⊙ Software-engineering, SPS programming, visualization
- ⊙ Own switchboard production (from single parts to large-scale productions)
  - ⊙ Electronics development and own electronics production
  - ⊙ Construction and production of your mechanics up to special purpose machinery manufacture
  - ⊙ Software according to IEC61131 (compliant to PLCopen), Baumüller ProMaster/ProProg/ProViz, SIEMENS TIA and S7, PCS7, WinCC etc.



**BAUMÜLLER**

**ENGINEERING**

- ⊙ Mounting
- ⊙ Startup monitoring, tests
- ⊙ Worldwide commissioning
- ⊙ Production attendance incl. training of the operating and maintenance staff
- ⊙ Training and consulting services
- ⊙ Relocation



## Mounting and commissioning

## Mounting, commissioning and system service



### Mounting and commissioning

Whether inhouse or worldwide at your customers on site – on demand we mount your complete machine or system and make the commissioning as well as all the required tests. Thereby, we take into account the accordant country-specific standards. We take the overall responsibility of the project from the planning to the readiness for commissioning.

In cooperation we will develop and plan your individual needs and requirements to meet the most efficient solution. We focus on the realization of the project. Your core competences no matter if development, construction or application technologies remain unaffected. Referring to your construction and quality requirements we carry out mechanical and electrical mounting and assemble your individual components, complete machines or systems.

### Relocation

As we are a general contractor we accept the responsibility for individual machines and systems, complete production lines and production sites. Our highly qualified staff team operates worldwide. We have got the correct solutions for your the packing and the transport process – of course as well in international business. We operate independent of the business sector and for our customers we move around internally, national as well as international. The sky's the limit.



## BAUDIS – Diagnostics and remote servicing system

For many years the diagnostics and remote servicing system BAUDIS is worldwide used for Baumüller's customers and since then was continuously developed and functionally extended. The core task of this system is the monitoring, setting and the optimization of the drive systems. Due to remote servicing and diagnostic options downtimes can be avoided, maintenance times can be planned proactively and the service costs and maintenance can sustainably be reduced.

The system is available of a platform-independent architecture and enables a system diagnosis via the intranet and internet due to the web-based operation. The system is able to flexibly be integrated in the system-dependent control stations and can process and present the diagnostic data platform-independent.

## Baudis IoT – The first step towards Industry 4.0

Our condition monitoring system BAUDIS IoT monitors your system and critically process all around the clock. By recognizing them in time. Due to the early detection of imminent mechanical defects and electrical errors an unscheduled machine downtime can be avoided. Condition monitoring is an essential part of advanced preventive maintenance planning. In cooperation with you we will work out the optimal concept for your system and its components.

If required our service team is informed by email and at first accesses the machine by safe remote maintenance can access the machine at first are able to access. This way an early diagnosis can be performed and a potential maintenance assignment can be planned. If service calls are required at short notice our service experts are available worldwide and within shortest time.

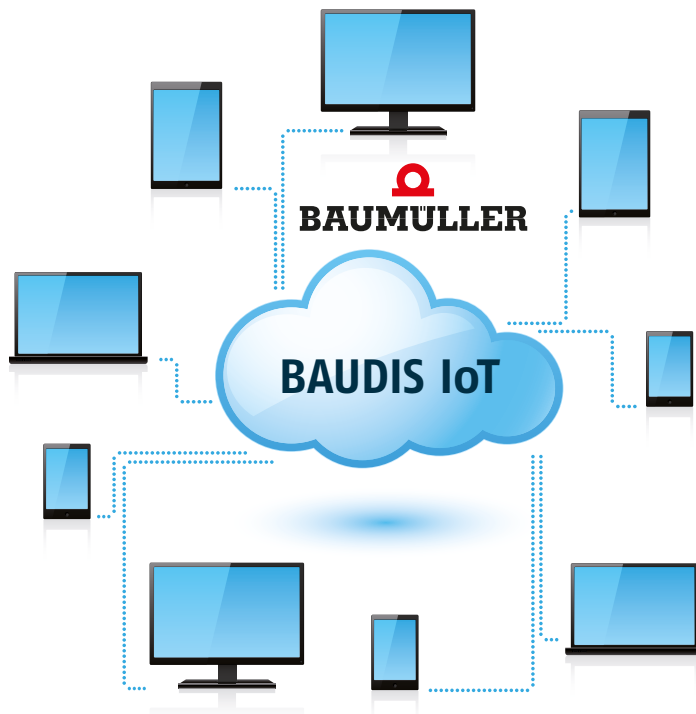
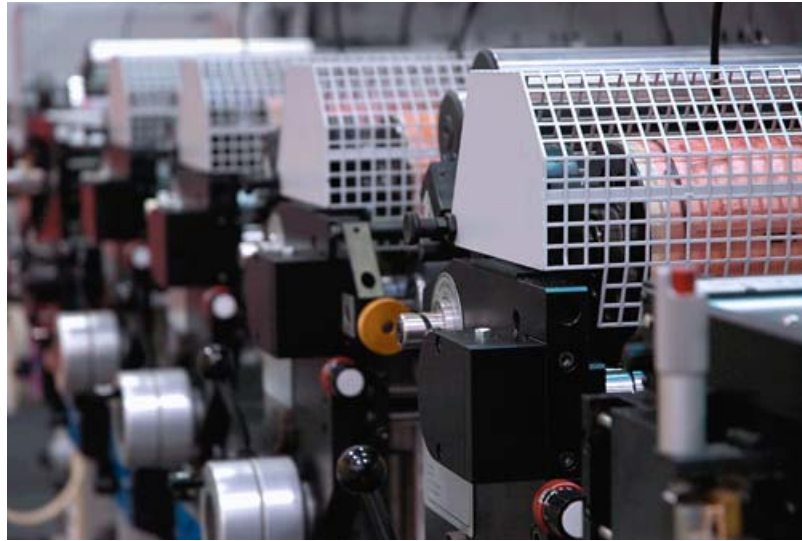

### Your advantage

- ⊙ Optimally monitoring of parts susceptible to wear
- ⊙ Avoidance of secondary damages
- ⊙ Detailed error diagnosis
- ⊙ Up to 22% lower standstill times
- ⊙ Fewer sales losses
- ⊙ Increase of machine lifetime
- ⊙ Increase of machine availability

## System service, maintenance and retrofitting



## System service and maintenance



Throughout the complete lifecycle of your system we ensure the reliability and productivity of your machine with our comprehensive selection in the service and maintenance range. Our longstanding experience, our know-how as well as the technical equipment of our subsidiaries are the basis of high-quality services from the exchange of defect parts up to general maintenance.

A global dense network of subsidiaries and partner businesses make a service of service technicians at short-term possible. Our mobile service teams perform maintenances on site if technical possible and this way minimize standstill times. We are your service partner for repair and maintenance partner and regardless of the manufacturer.



## Retrofit and modernization

We provide manufacturer-independent, customized and multi-stage solutions to advance your electrical drive and automation systems. Using the new drive components you reach a quick and increased flexibility and increase the productivity of your system at manageable costs. Existing machines are equipped with the latest Baumüller components and operating interfaces and thereby achieve an increased system availability and process safety.

We support you throughout the entire retrofit project – from the project planning to the commissioning and to the maintenance. The Baumüller group thereby provides a broad product and services portfolio from one single source, which enables economical and future-proof as well as complete efficient solutions.

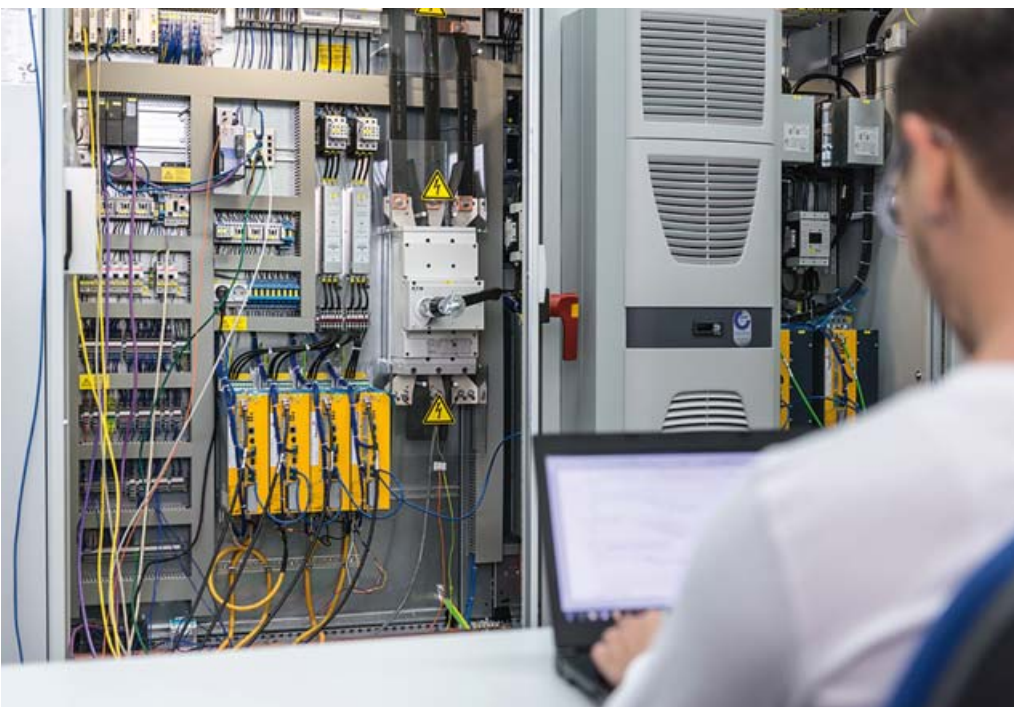
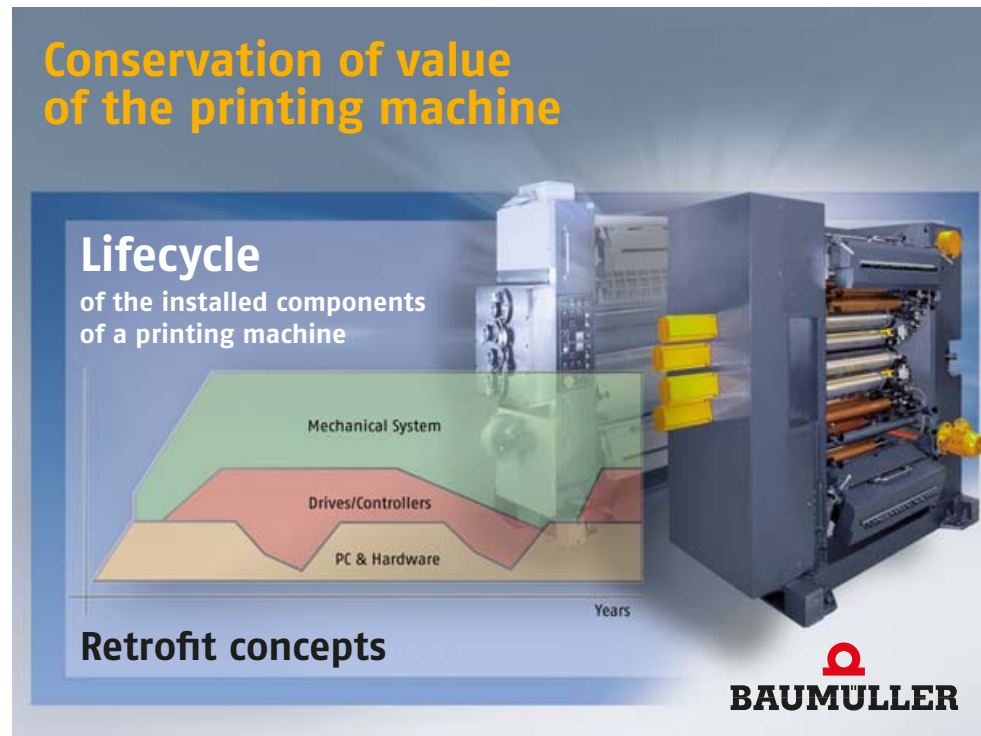

### Your advantage

- ⊙ Cost saving in the company by lower energy consumption and lower service costs
- ⊙ Time and cost saving by making advancements instead of new purchases
- ⊙ Future-proof due to guaranteed availability of spare parts and services
- ⊙ Increased reliability by advanced technology
- ⊙ Increasing productivity with optimized processes/new functions
- ⊙ Simplified operation and extended functions by new features (operation with mobile terminal devices, version handling etc.)

# ProMaster Engineering Framework

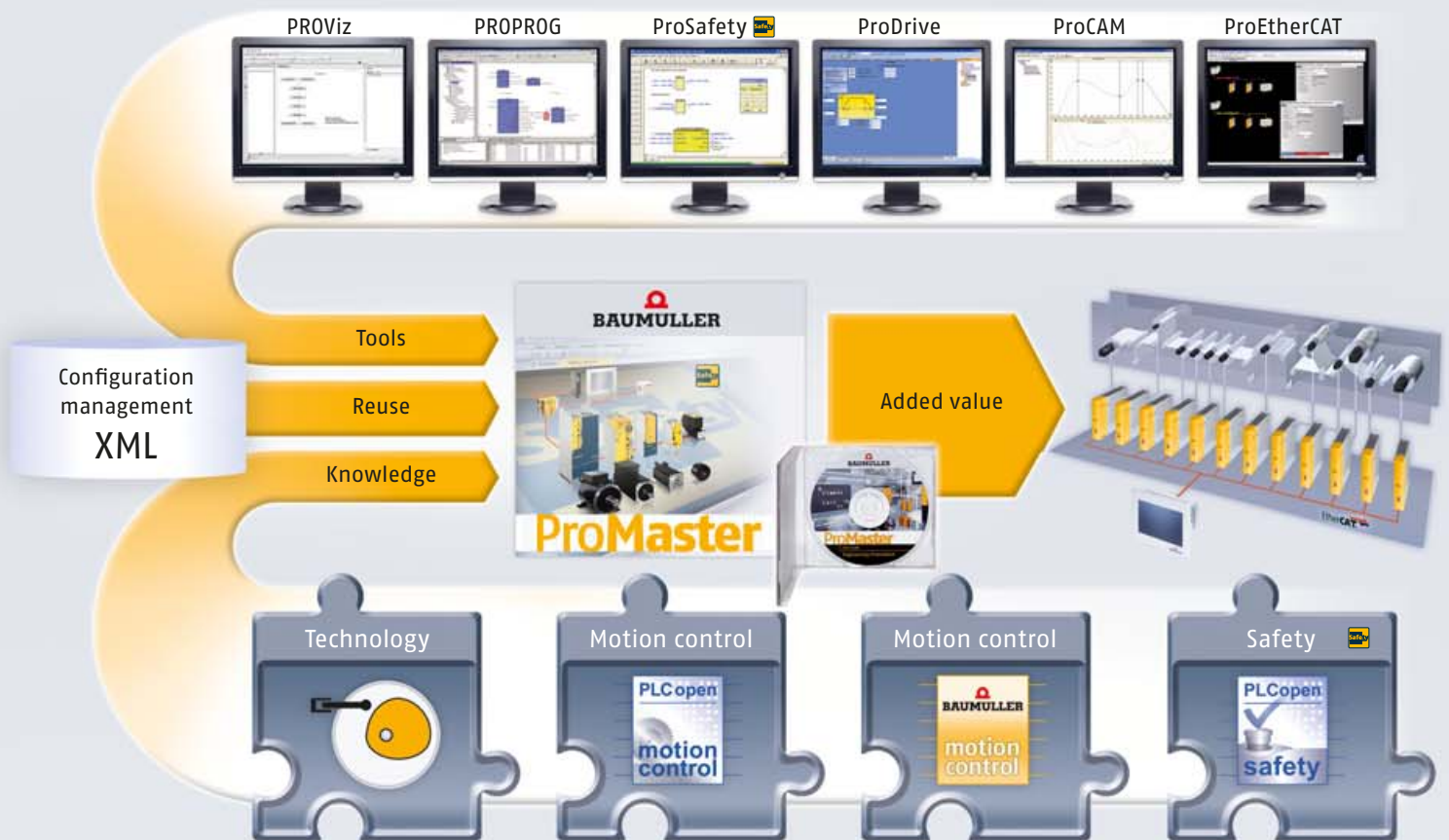

The more intuitive the engineering, the more efficient the automation solution will be. ProMaster allows you to introduce new machine concepts to the marketplace more quickly and you systematically increase the added value of your machine.

Consistent machine configuration, parametrization, programming and diagnosis are the fundamental aspects for a machine-oriented application. The implementation of the independent standards such as Motion Control functionalities in accordance with PLCopen or EtherCAT field bus are used.

Your knowledge is managed in the form of parameters and functions in data-sets and libraries – throughout the entire lifecycle of the machine.



## Operating and visualizing using the b maXX HMI

The b maXX HMI series provides a powerful hardware, a comprehensive software and a lot of function. The devices are available in a Standard and in a Basic product line – the display sizes reach from 4.3 to 15.6 inches and in the product line Premium from 7.0 to 15.6 inches. All HMIs use an ARM Cortex A9 1.0 GHZ processor. The scope of supply covers an USB as well as Ethernet ports and a configurable serial interface.

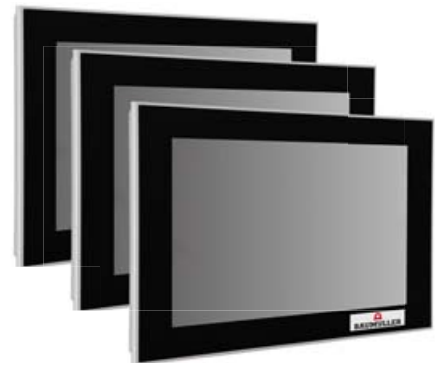

## Drive-Integrated control system

The intelligent control b maXX-drivePLC, which is completely integrated in the engineering framework ProMaster, allows a very fast access to the setpoints and actual values of the drive controller. With this, the drive function can now be extended by complex motion control-, technology- and control functions. Furthermore, with the use of the softdrivePLC, Baumüller has integrated SPS functions directly in the controller and thus additional control hardware for specific applications is no longer necessary. In this way, a decentralized control architecture for the programming in accordance to IEC 61131 is created. Control jobs, as for example simple calculations of digital inputs up to extremely complex control algorithms, can now be easily implemented via the parameterization tool ProDrive.



## b maXX Controller PLC – Modular and safe

The b maXX Controller PLC consistently implements the concept of scalability and modularity for flexible individual adapting by the mechanical engineer. Thus the b maXX PLC02-Safe has extended the standard motion control range by a two-channel safety control system that fulfils the requirements of IEC 61508 to SIL3 and EN 13849 to PL e. This is the first certificated EtherCAT Motion Control PLC with integrated safety function.



## b maXX-PCC – PC based PLC

The calculation performance of an industrial PC in the combination with a powerful PLC completes the range of control systems with a reliable and innovative platform. It is equipped with components of the highest level of performance and is based on open standards in the fields of automation and IT. Multi-core processor architecture provides decisive advantages for automation solutions: various different functions can be distributed and the calculation performance can be allocated to the various tasks. It therefore not only fulfils the high real-time requirements of calculation-intensive applications in a control system, it also takes on additional tasks such as visualization or IT linking on a platform. Both box and panel versions are available.



# Converters



## **b maXX 5000 – Unrivalled dynamics and compactness**

By using a comprehensive portfolio of drive electronics your machine will be more efficient. Our high-performance power units are connected to an integrated communication concept and can be obtained in the versions: Air, water and coldplate. The converters and controllers of Baumüller can be used to implement standardized as well as complex automation solutions. The b maXX 500 series provides a power spectrum of 1 dW to 100 dW in a rack system and up to 368 kW as a mono output. With power supplied and regenerative systems, b maXX 5000 can be used worldwide as an energy efficient drive system

By optional SAF modules the user can quickly and flexibly respond to new safety demands. The b maXX 5000 ideally meets the scalable safety function range of the modules the guidelines of EN ISO 13849 up to SIL 3.

## **b maXX 4000 – Modular, scalable, open**

Baumüller's approved automation and drive solution b maXX can be adapted to the corresponding demands with respect to performance and equipment through its modularity and flexibility. b maXX 4000 offers a power spectrum from 1.1 kW up to 315 kW with different cooling concepts, such as air and water cooling or cold plate variants. With the series b maXX 4100 a regenerative system is at your disposal, which fits in the automation solution b maXX perfectly. Drive-integrated functional safety is provided optionally.



## **b maXX 3000 – Versatile mini servo controller**

b maXX 3300 is a high-quality servo controller with integrated position control for power rating up to 5 kW. The b maXX 3300 is characterized by its compact and space-saving design. The field-oriented control provides an excellent rotational accuracy. Higher-level speed and position control ensure dynamic and exact positioning. The servo controller is specifically designed for operation with servomotors of the DSC, DSP and DSD series as well as the Baumüller disc rotor and linear motor series. Functional safety features integrated into the drive are available as well as the manual control device.



## **b maXX 2500 – Compact mini servo controller**

In the b maXX 2500 Baumüller combines its proven converter of the 3300 series with the robust servo motor DSD2, DSC and DSP1. This way a compact drive with integrated electronics for the high-end segment was created.



## **b maXX 2400 – Compact mini servo controller**

b maXX 2400 rounds down the converter and controller generation b maXX according to its power rating. The mini servo controller b maXX 2400 (<60 V) is specifically designed for operation with the DSD 28–36 servomotors and the disc rotor motor series of Baumüller.



## **b maXX 1000 – Highly efficient frequency converter**

For a vector control of standardized motors Baumüller added an high-efficient and easy to operate frequency converter to the program: The b maXX 1000 is available in three sizes with capacity ranges from 0.2 to 11 kW.



## **DSDI/DSMI – Motors with integrated control/power electronics**

The DSD/DSMI servo motors with integrated control and power electronics fulfill the demands of advanced decentralized drive architectures in the automation. The DSDI is a high torque servo drive. Power range 170–385 W (0.23–0.52 hp), speeds up to 6000 min<sup>-1</sup>, type of protection up to IP65.



# Motors

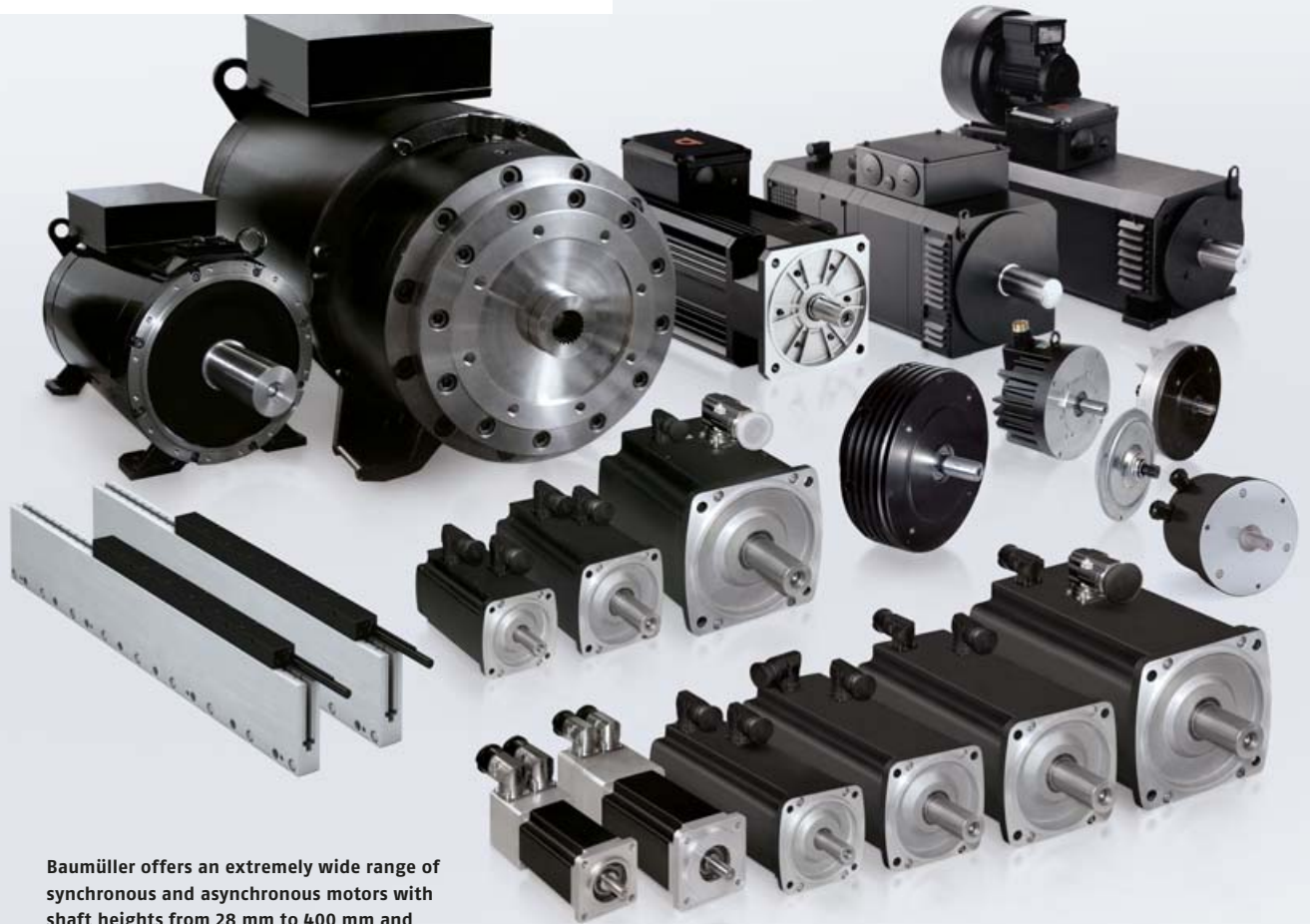

Baumüller offers an extremely wide range of synchronous and asynchronous motors with shaft heights from 28 mm to 400 mm and many different cooling methods.



## DS/DA – General purpose servo motors

The servo motor for all applications with strict energy efficiency requirements. Type DS: Sizes 45, 56, 71, 100, 132, 160, 200, power range 0.25–295 kW (0.33–396 hp), speeds up to 6000 min<sup>-1</sup>, type of protection: unventilated IP54, ventilated IP23/IP54, water-cooled IP54.

Type DA: Sizes 100, 132, 160, 180, 225, 280, power range 3.5–400 kW (4.7–536 hp), speeds up to 3000 min<sup>-1</sup>, type of protection: ventilated IP23/IP54, water-cooled IP54.



## DSC – Compact servo motors

The DSC 45–100 is a series of high-torque servo motors that are up to 30% more compact than conventional servo designs.

Sizes 45, 56, 71, 100, power range 0.5–18 kW (0.67–24 hp), speeds up to 4000 min<sup>-1</sup>, type of protection up to IP65.

### **DSP – For high speed performance**

For applications requiring high speed demands, DSP motors complete the existing DSC range with nominal speed up to 6000 min<sup>-1</sup>. Sizes 45, 56, 71, 100, power range 1.2–32 kW (1.6–43 hp), speeds up to 6000 min<sup>-1</sup>, type of protection IP65.

### **DSD – Dynamic servo motors**

The servo motors for highly dynamic applications with the highest requirements of acceleration capacity and the best start-stop qualities. Sizes 28, 36, 45, 56, 71, 100, power range 0.28–42 kW (0.38–56 hp), speeds up to 6000 min<sup>-1</sup>, type of protection IP65.

### **DST – Powerful high torque motors**

The high-torque motor DST2 for applications with highest torque requirements. Sizes 135, 200, 260, 315, 400, 500, 650, power range 2.7–320 kW (3.6–429 hp), speeds up to 1500 min<sup>-1</sup>, torque up to 32,900 Nm, type of protection IP54, water-cooled.

### **GDM & DSM – Disc motors**

Baumüller offers a wide range of disc rotors for use in a large number of different applications where installation space is very limited. GDM DC disc motors: Power range 16–3000 W (0.02–4 hp) DSM brushless disc motors: Power range 180–6300 W (0.24–8.4 hp).

### **DSE – Embedded AC synchronous motors**

The DSE synchronous motors are available either as a housing version or as a built-in motor. With its buried magnets and a rotational speed range up to 9000 rpm, the motor convinces with a particularly high power density.

### **BPx – Planetary gear series**

The BPx planetary gear series in combination with our standard DSP/DSD/DSC servo motors is ideally suited for applications with high demands on torque and dynamic.

### **LSC – Ironless linear motors**

The LSC ironless linear motors of Baumüller provide maximum current and force rising speeds. This makes them ideal for highly dynamic applications with a maximum stiffness to disturbance forces.

### **DSDI/DSMI – Motors with integrated control/power electronics**

The DSD/DSMI servo motors with integrated control and power electronic fulfill the demands of advanced decentralized drive architectures in the automation. The DSDI is a high torque servo drive. Power range 170–385 W (0.23–0.52 hp), speeds up to 6000 min<sup>-1</sup>, type of protection up to IP65.





**Baumüller Nürnberg GmbH**, Ostendstraße 80–90, 90482 Nürnberg, Phone: +49 (0) 911 5432–0, Fax: +49 (0) 911 5432–130 [www.baumueller.com](http://www.baumueller.com)

**Baumüller Anlagen-Systemtechnik GmbH & Co. KG**, Ostendstr. 84, 90482 Nürnberg, Phone: +49 (0) 911 54408–0, Fax: +49 (0) 911 54408–769

**Baumüller Reparaturwerk GmbH & Co. KG**, Andernacher Straße 19, 90411 Nürnberg, Phone: +49 (0) 911 9552–0, Fax: +49 (0) 911 9552–999

**Baumüller DirectMotion GmbH**, Flugplatzweg 2, 37581 Bad Gandersheim, Phone: +49 (0) 5382 9805–0, Fax: +49 (0) 5382 9805–55

[www.baumueller.de](http://www.baumueller.de)