

Application handbook

Language **English**
Translation
Document No. 5.14010.05
Part No. 452984
Status 1-Mar-2018

be in motion **be in motion**

The logo for BAUMÜLLER, featuring a red stylized Greek letter Omega symbol above the brand name in a bold, black, sans-serif font.

b maXX

SoE slave

for b maXX

2500 / 3300 / 5000

E	5.14010.05
----------	------------

Read the Instruction handbook before starting any work!

- Copyright These Application handbook may be copied by the owner in any quantity, but only for internal use. This Application handbook may not be copied or reproduced, in whole or in part, for any other purposes.
The use and disclosure of information contained in these Application handbook are not permitted.
Designations and company marks contained in these Application handbook could be trademarks, the use of which by third parties for their own purposes could violate the rights of the rights holder.
- Preliminary information **Warning** Insofar as this document is identified as being preliminary information, the following applies:
this version is regarded as providing advance technical information to users of the described devices and their functions at an early enough time in order to adapt to any possible changes or expanded functionality.
This information must be regarded as being preliminary, as it has not yet passed through Baumüller's internal review process. In particular, this information is still subject to changes, thus no legal liability can be derived from this preliminary information. Baumüller assumes no liability for damages that might arise from this possibly faulty or incomplete version.
If you detect or suspect any content errors and/or major form errors in this preliminary information, we request that you notify the Baumüller support specialist responsible for you. Please provide us, via this employee, with your insights and comments so that we can take them into account and include them when transitioning from the preliminary information to the final information (as reviewed by Baumüller).
The conditions stipulated in the following section under „Obligatory“ are invalid in case of preliminary information.
- Obligatory These Application handbook are a part of the equipment/machine. These Application handbook must be available to the operator at all times and must be in legible condition. If the equipment/machine is sold or moved another location, these Application handbook must be passed on by the owner together with the equipment/machine.
After any sale of the equipment/machine, this original and all copies must be handed over to the buyer. After disposal or any other end use, this original and all copies must be destroyed.

When the present Application handbook are handed over, corresponding sets of operating instructions of a previous version are automatically invalidated.
Please note that the specifications/data/information **are current values according to the printing date**. These statements are **not legally binding** with regard to measurements, computation or calculations.
Baumüller Nürnberg GmbH reserves the right, in developing its products further, to change the technical specifications and handling of its products concerned without prior notice.

No liability can be accepted concerning the correctness of these Application handbook unless otherwise specified in the General Conditions of Sale and Delivery.

© **Baumüller Nürnberg GmbH**

Ostendstr. 80 - 90
90482 Nuremberg
Germany

Tel. +49 9 11 54 32 - 0
Fax: +49 9 11 54 32 - 1 30

Email: mail@baumueller.de
Internet: www.baumueller.de



Table of Contents

1	General Information	5
1.1	Explanation of symbols	6
1.2	Limitation of liability	7
1.3	Copyright	7
1.4	Guarantee conditions	8
1.5	Customer service	8
1.6	Terms used	8
1.7	Literature on the subject EtherCAT	8
1.8	Other applicable documents	9
2	Fundamentals Sercos	11
2.1	Literature	11
2.2	Communication phases/ phase run-up	11
2.3	Error and status messages	13
2.4	Service channel	14
2.4.1	Identification code (IDN)	14
2.4.2	Name	14
2.4.3	Attribute	14
2.4.4	Unit	15
2.4.5	Minimum value	15
2.4.6	Maximum value	15
2.4.7	Operating data	15
2.4.8	Data status	15
3	Communication to the b maXX Controller	19
3.1	Service data communication	19
3.1.1	S parameters	19
3.1.2	P parameters	19
3.2	State machine	20
3.2.1	b maXX controller	20
3.2.2	Sercos profile	22
3.3	Scaling	23
3.3.1	Position data	23
3.3.2	Speed data	26
3.3.3	Acceleration and jerk data	28
3.3.4	Torque and force data	30
4	Data Exchange and Parametrization	33
4.1	Data contents	33
4.1.1	Data terms	33
4.2	Communication parameters	34
4.2.1	EtherCAT SoE	34
4.3	Telegram	35
4.4	Configuration parameters of the controller	36
5	Configuration Options of Fieldbus Slave	37
5.1	Network settings for EoE (Ethernet over EtherCAT)	37



Table of Contents

6	Operation Modes	39
6.1	General information	39
6.2	Operation mode parameters	40
7	Commands	43
7.1	General information	43
7.2	Supported commands	44
7.3	Allocation of realtime bits	45
7.4	Homing	47
7.4.1	Command „Drive controlled homing“	47
7.4.2	Homing by the control	49
7.4.2.1	Command „Control unit controlled homing“	49
7.4.2.2	Command „Calculate displacement“	51
7.4.2.3	Command „Displacement in reference system“	52
7.5	Touch probe	53
7.5.1	Command probe cycle	54
7.6	Parking axis	55
7.7	Command Spindle positioning	56
7.7.1	Speed value > positioning speed	56
7.7.2	Actual speed ≤ positioning speed	57
7.7.3	Actual speed = 0	58
7.7.4	New positioning values during the command is active	58
7.7.5	Change of the spindle positioning mode, during an active command	58
8	Parameters	59
8.1	Structure of the parameters	60
8.1.1	Structure of the parameter description	60
8.2	Standard parameters	61
9	Error Handling	149
9.1	Errors of the fieldbus controller	149
9.1.1	Fatal errors	149
9.1.2	Configuration errors	149
9.2	Errors of the drive controller	149
9.3	Error parameters	150
9.4	Error and warning messages of the fieldbus controller	151
9.5	Error reset	154
9.6	Clearing the warning bit	154
9.7	Clearing the message bit	154
Appendix A - Definitions and Abbreviations		155
A.1	Definitions	155
A.2	Abbreviations	158
Appendix B - List of Parameters		159
B.1	List of P parameters	159
B.2	List of S parameters	180
Table of Figures		187
Index		189
Revision Survey		191

1

GENERAL INFORMATION

The application manual provides important information regarding handling the device. A prerequisite for safe working is compliance with all specified safety information and handling instructions.

Furthermore, the local accident prevention regulations and general safety requirements applicable to the area of application of the device must be observed.

Before starting any work on the device, completely read through the Instruction handbook, in particular the chapter on safety information. The Instruction handbook is an integral part of the product and must be kept in the immediate vicinity of the device in order to be accessible to personnel at all times.

For commissioning of the device the parameter manual must be used. The parameter manual contains information to the parameters of the device.

The application manual SoE slave provides information about the configuration and commissioning in a SoE network of b maXX 2500 / 3300 / 5000 devices for controller firmware from version 01.07.

1.1 Explanation of symbols

Warnings

Warnings are identified by symbols in this Parameter Manual. The notices are introduced by signal words which express the magnitude of the danger.

Observe the notices without exception and exercise caution to prevent accidents, personal injury and damage to property.



DANGER!

...warns of an imminently dangerous situation which will result in death or serious injury if not avoided.



WARNING!

...warns of a potentially dangerous situation which may result in death or serious injury if not avoided.



CAUTION!

...warns of a potentially dangerous situation which may result in minor or slight injury if not avoided.



NOTICE!

...warns of a potentially dangerous situation which may result in material damage if not avoided.

Recommendations



NOTE!

...points out useful tips and recommendations, as well as information for efficient, trouble-free operation.

1.2 Limitation of liability

All specifications and information have been compiled taking account of the applicable standards and regulations, the state of the art and also our many years of expertise and experience.

The manufacturer accepts no liability for damage resulting from:

- Non-compliance with the Operating Manual
- Non-intended use
- Use of untrained personnel

The product actually supplied may deviate from the versions and illustrations described here in the case of special versions, the use of additional ordering options or as a result of the latest technical changes.

The user is responsible for carrying out servicing and maintenance in accordance with the safety regulations in the applicable standards and all other relevant national or local regulations concerning conductor dimensioning and protection, grounding, isolation switches, overcurrent protection, etc.

The person who carried out the assembly or installation is liable for damage arising during assembly or upon connection.

1.3 Copyright

Treat the Application handbook confidentially. It is intended exclusively for persons involved with the device. It must not be made available to third parties without the written permission of the manufacturer.



NOTE!

The details, text, drawings, pictures and other illustrations contained within are copyright protected and are subject to industrial property rights. Any improper exploitation is liable to prosecution.

CiA[®] and **CANopen[®]** is a registered trademark of CAN in Automation e.V.
90429 Nürnberg, Germany

EtherCAT[®] is a registered trademark of Beckhoff Automation GmbH,
33415 Verl, Germany

Sercos[®] is a registered trademark of Sercos International e. V.

b maXX[®] is a registered trademark of Baumüller Nürnberg GmbH,
90482 Nürnberg, Germany



NOTE!

Please note, that BAUMÜLLER is not responsible to examine whether any (industrial property) rights of third parties are infringed by the application-specific use of the BAUMÜLLER products/components or the execution.

1.4 Guarantee conditions

The guarantee conditions are located as a separate document in the sales documents.

Operation of the devices described here in accordance with the stated methods/ procedures / requirements is permissible. Anything else, e.g. even the operation of devices in installed positions that are not shown here, is not permissible and must be checked with the factory in each individual case. If the devices are operated differently than described here, any guarantee will be invalidated.

1.5 Customer service

Our customer service department is available for technical information.

Information concerning the responsible contact person can be obtained at any time by telephone, fax, e-mail or over the internet.

1.6 Terms used

For abbreviations used, see [▶Appendix A - Definitions and Abbreviations◀](#) from page 155.

1.7 Literature on the subject EtherCAT

Further information are available via EtherCAT organization. The EtherCAT organization is available on website www.EtherCAT.org.

EtherCAT is standardized in IEC 61158. The used Sercos profile SoE is defined in standard IEC 61800-7 and IEC 61491.

1.8 Other applicable documents

Instruction hand- book

	Doc.-No.	Part No. German	Part No. English
Instruction handbook b maXX 2500	5.14012		
Instruction handbook b maXX 3000	5.11018	441838	441839
Instruction handbook b maXX 5000	5.09021	439682	439683
Instruction handbook b maXX 5500	5.13008	446683	446684

Parameter manual

	Doc.-No.	Part No. German	Part No. English
Parameter manual b maXX 2500/3000	5.12001	442289	442290
Parameter manual b maXX 5000	5.09022	428331	431082

Instruction hand- book Add-on module

	Doc.-No.	Part No. German	Part No. English
Add-on module incremental encoder emulation IEE	5.13030	448189	448190

Application hand- book fieldbus

	Doc.-No.	Part No. German	Part No. English
CANopen, CoE and POWERLINK for b maXX 2500/3000/5000	5.14006	450922	450923
SoE slave for b maXX 2500/3000/5000	5.14010	452983	452984

FUNDAMENTALS SERCOS

2.1 Literature

The used Sercos profile SoE is defined in standard IEC 61800-7 and IEC 61491.

2.2 Communication phases/ phase run-up

The system passes through several states (that means communication phases) after switching on the power supply, before reaching the normal operation state (= communication phase 4).

The tasks and options of the several communication phases are specified below.

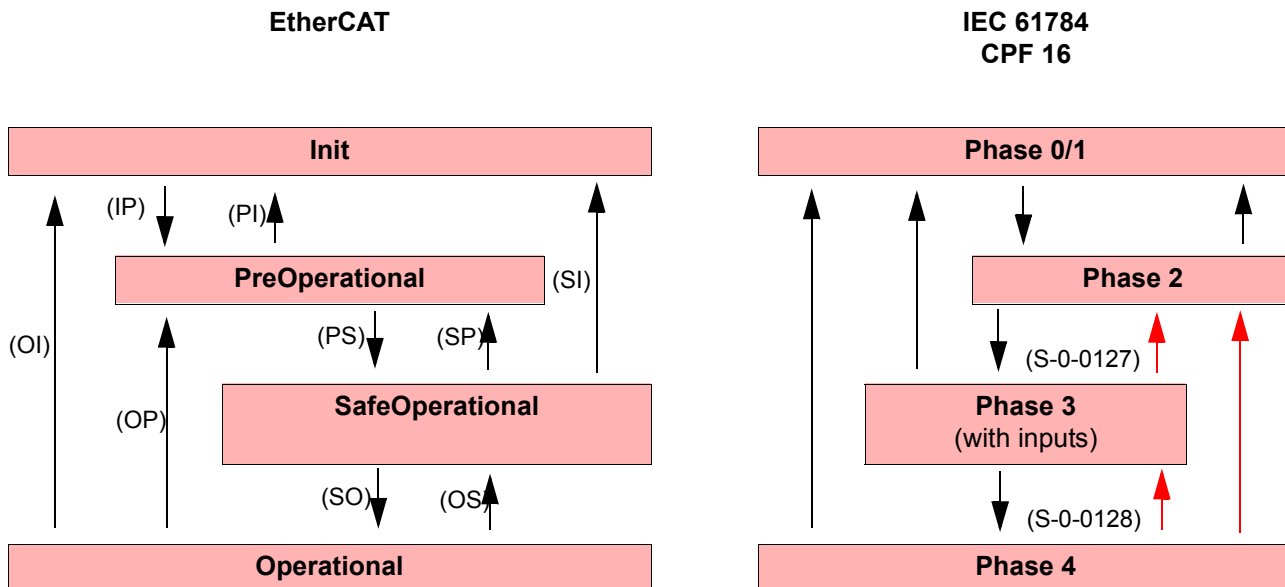

Initialization phase (Init)

The internal communication to the controller is established. If communication runs with the controller then the configuration- as well as further parameters for internal purposes are read out by the controller.

After reading the controller parameter a change to communication phase to follows.

Communication phase 2 (CP2 / PreOperational)

From PreOperational on the mailboxes for the service data communication between master and slave are configured.

In this communication phase the information about the synchronization-time (cycle period) and -mode (distributed clocks or telegram receipt) has to be sent to the slave.

The EtherCAT-master requests the slave to change in status „SafeOperational“, after configuring the necessary parameters. Thereupon the drive checks, if this is possible.

If this check was successful the drive changes in state „SafeOperational“.

Communication phase 3 (SafeOperational)

In this communication phase the total communication cycle including all telegrams has been completely configured. The drive synchronizes on the specified cycle.

With EtherCAT the actual values from the drive in „SafeOperational“ are valid. However, in this status the values are not accepted by the drive. In this phase the EtherCAT Master can generate a mapping of the actual drive status.

The master now can initiate the switch-over to „Operational“. Now the slave checks if an error-free operation is possible and changes to state „Operational“.

Communication phase 4 (Operational)

In this phase the cyclic communication is running according to configuration. The drive is synchronous, because otherwise there would have been no change to this state.

2.3 Error and status messages

In the status word of each drive grouped messages of the classes 1, 2, and 3 diagnostic (C1D, C2D, C3D) are defined. The according bit is either set if there is an error (C1D) or if something changes in the according diagnostic class (C2D and C3D).

C1D

An error message of class 1 diagnostic (C1D) means that in the drive an error status was determined, which leads to a shutdown with subsequent $Md = 0$. This process is executed by the drive itself.

If bit 15 is set, a manufacturer-specific error message was generated. The number of the controller error then is saved in [▶S-0-0129◀](#).

Additional information on resetting and evaluation of errors is to be found in [▶Error Handling◀](#) from page 149.

C2D

A message of diagnostic class 2 diagnostic (C2D) means a warning indicating a possible shutdown.

The C2D bit in status word is reset when reading out the [▶S-0-0012◀](#).

If bit 15 is set, there is a manufacturer-specific warning. The number of the b maXX-controller warning then is saved in the [▶S-0-0182◀](#).

C3D

Messages of class 3 diagnostic (C3D) are pure status messages (e. g. $|n_{\text{actual}}| < |n_x|$).

The C3D bit in the status word is reset, when reading out the [▶S-0-0013◀](#).

2.4 Service channel

The service channel is used for the non-cyclical service data communication. Communication is made via parameters. Each parameter has 7 elements:

- 1 Identification code IDN (mandatory)
- 2 Name (option)
- 3 Attribute (mandatory)
- 4 Unit (option)
- 5 Minimum value (option)
- 6 Maximum value (option)
- 7 Operating data (mandatory)

Only element 7 (operating data) of a parameter can be transmitted, with exception of write-protected parameters. All other elements (number, name, attribute, unit, minimum value, maximum value) can only be read.

2.4.1 Identification code (IDN)

There are two types of Sercos identification codes (IDNs), the so-called S parameters. These are parameters, which are defined in the standard IEC 61800-7-204 and the manufacturer-specific P parameters.

The IDN is specified as follows:

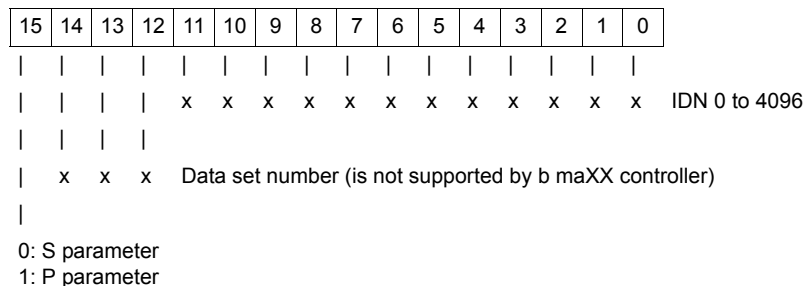

Figure 1: Identification code

2.4.2 Name

The parameter name must not be longer than 80 bytes. The description language can be selected via the parameter [▶S-0-0265◀](#). Via [▶S-0-0266◀](#) you can check, which languages are supported.

2.4.3 Attribute

The attribute contains information, which is necessary to clearly show the operating data.

2.4.4 Unit

The unit is stored as a character string. There is no unit at the operating data, if the data type is either a binary number, a character string or an IDN.

2.4.5 Minimum value

The minimum input value is the smallest numerical value of the operating data, which can be processed by the drive.

There is not a minimum value at the operating data, if it is a binary number, a character string or an operating data of variable length.

2.4.6 Maximum value

The maximum input value is the greatest numerical value for the operating data which can be processed by the drive.

There is not a maximum value at an operating data, if it is a binary number, a character string or an operating data of variable length.

2.4.7 Operating data

There are three operating data categories:

- fixed length 2 bytes
- fixed length 4 bytes
- variable length up to 65532 bytes

2.4.8 Data status

The content of „Data status“ is related to the entire data block. „Data status“ contains conditions which change dynamically.

In EtherCAT the data status is transmitted with the regular response telegram by the slave. At write / read activity to common IDNs the data status is written to the „Error“-field.

When executing commands a separate telegram (Notify SCC Command Execution) is sent by the slave when the command processing is completed. It contains the data status of the command in a separate field „Data status“.

- Status value at service data

Error group bits 15 ... 12	Error type Bits 7 ... 0	
0x0		General error
	0x00	No error in the service channel
	0x01	Service channel is not opened
	0x09	Invalid closing of the service channel
0x1		Element 1
	0x01	Identification code nonexistent
	0x09	Invalid access to element 1
0x2		Element 2
	0x01	Name is not existent
	0x02	Name transmission too short
	0x03	Name transmission too long
	0x04	Name cannot be changed (read only)
	0x05	Name is write-protected at the moment
0x3		Element 3
	0x02	Attribute cannot be transmitted
	0x03	Attribute transmission too long
	0x04	Attribute cannot be changed (read only)
	0x05	Attributes are write-protected at the moment
0x4		Element 4
	0x01	Unit is not existent
	0x02	Unit transmission too short
	0x03	Unit transmission too long
	0x04	Unit cannot be changed (read only)
	0x05	Unit is write-protected at the moment
0x5		Element 5
	0x01	Minimum input value not existent
	0x02	Minimum input value transmission too short
	0x03	Minimum input value transmission too long
	0x04	Minimum input value cannot be changed (read only)
	0x05	Minimum input value is write-protected at the moment
0x6		Element 6
	0x01	Maximum input value is not existent
	0x02	Maximum input value transmission too short
	0x03	Maximum input value transmission too long
	0x04	Maximum input value cannot be changed
	0x05	Maximum input value is write-protected at the moment

Error group bits 15 ... 12	Error type Bits 7 ... 0	
0x7		Element 7
	0x02	Operation data transmission too short
	0x03	Operation data transmission too long
	0x04	Operation data cannot be changed (read only)
	0x05	Operation data is write-protected in this communication phase
	0x06	Operation data is less than the minimum input value
	0x07	Operation data is greater than the maximum input value
	0x08	Invalid operating data (for example invalid bit combination for this parameter number)
	0x09	Operation data is password protected
	0x0A	Operation data is write-protected, because it is configured in cyclic data (MDT or AT)
	0x0B	Invalid indirect addressing (e.g. list handling)
	0x0C	Operation data is write-protected, because of certain settings (e.g. parameter scaling, operation mode, drive enables, and so on)
	0x0D	Invalid floating point number
	0x0E	Operation data is write-protected in this operation mode
	0x10	Command procedure is already active
	0x11	Command procedure cannot be interrupted
0x12	Command procedure is not executable at this time (e.g. in this phase it cannot be executed)	
0x13	Command procedure is not executable (invalid or wrong parameter)	

• Status values at commands

15	14	13	12	11	10	9	8	7	6	5	4	3	2	1	0
															0: Command in drive not set
															1: Command in drive set
															0: Procedure command in drive interrupted
															1: Execution of command enabled in drive
															0: Command is properly executed
															1: Command is not yet executed
															0: No command error
															1: Procedure command not possible
x	x	x	x	x	x	x	x	x	x	x	x	x	x	x	Reserved

Figure 2: Status values at commands

3

COMMUNICATION TO THE b maXX CONTROLLER

This chapter describes the connection of the b maXX 2500 / 3300 / 5000 controller.

3.1 Service data communication

Service data communication to the controller is made via the service channel of SoE.

3.1.1 S parameters

S parameters are standard parameters, which are defined in Sercos profile.

With the service data communication also Sercos-specified commands are started and completed.

3.1.2 P parameters

P parameters are manufacturer-specific parameters. Herewith the internal parameters of the b maXX controller are activated directly and without conversion. P parameters are inquired for with their parameter No. and the set bit 15 (e. g. **P1000** = 0x83E8). If a parameter is not implemented the drive replies with the suitable message (IDN not existing).

3.2 State machine

3.2.1 b maXX controller

- State 1
There are no error messages. The drive reaches state 1, if the 24 V supply voltage is switched on and the parameters were correctly set in the b maXX controller.
- State 1 \Rightarrow State 2
If the following conditions are fulfilled, the fieldbus controller initiates the drive state 2:
 - Drive is error-free
 - DC-link is loaded
 - Sercos control word bit 14 and 15 are reset
- All the other transitions of the state machine are controlled by the Sercos control word of the MDT (see survey)

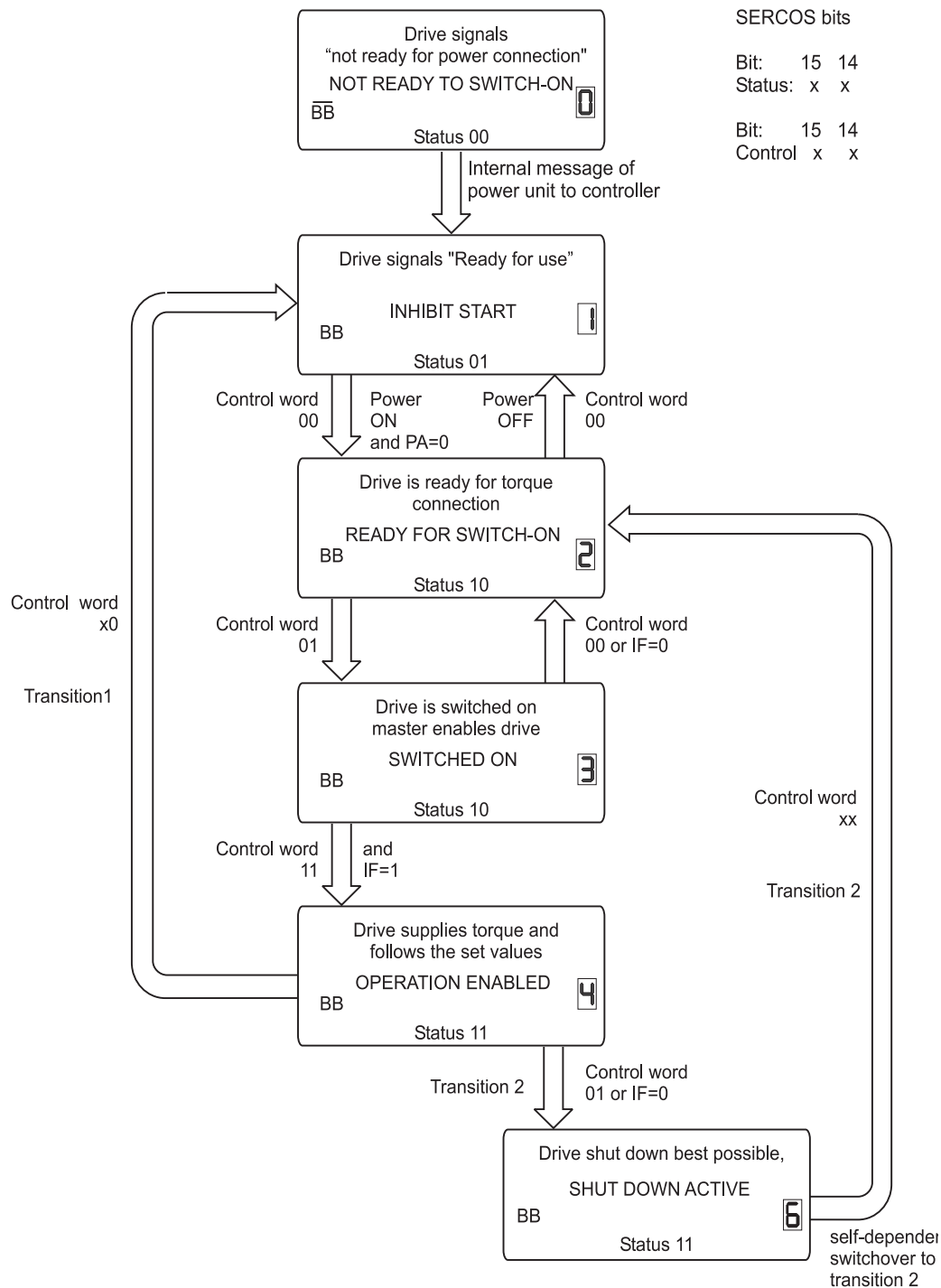

IF=1: Pulse enable on 1 level
 IF=0: Pulse enable on 0 level
 PA=0: Axis not parked
 PA=1: Axis parked

Figure 3: State machine

Also refer to [S-0-0134](#) master control word.

3.2.2 Sercos profile

The drive signals via the bits 14 and 15 in the Sercos status word the following states:

15	14	13	12	11	10	9	8	7	6	5	4	3	2	1	0
0	0	Not ready for power connection (state 0)													
0	1	Not ready for power connection (state 1)													
1	0	Drive is torque-free and power stage inhibited (state 2)													
1	1	Drive is ready-to-operate (state 4)													

Figure 4: Sercos status word

The transitions and the conditions for this are as follows:

- State 0 \Rightarrow state 1
This transition is made if the drive is error-free.
- State 1 \Rightarrow state 2
This transition is made if the following conditions are complied with:
 - power is connected
 - the drive is error-free (C1D = 0)
 - the bits 14 and 15 in the control word are reset

The effects of the bit 14 on the state change can be configured via the controller. The selection can be set via the parameter „Configuration profile“, bit 4 (**P1016**).

The following behaviour can be selected (bit 4 of the parameter):

- bit 4 = 0: Standard: bits 14 and 15 are evaluated
- bit 4 = 1: **Only** bit 15 is evaluated and must be reset, before transition is possible

- State 2 \Rightarrow state 3

This transition is made after the master has set the bits 14 (drive enable) and 15 (drive on) in the Sercos control word.



NOTE!

The parameter „Configuration profile“ is only evaluated at power up. Therefore, this setting must be saved in the b maX controller.

3.3 Scaling

The format of the Sercos parameters differs from the format of the b maXX controller parameters. That is why a conversion is necessary.

The conversion of position data, speed data, acceleration data and torque data is available.

Moreover you can select between a scaling of the preferred values and a scaling of random values with means of a freely-adjustable scaling parameter.

The selection of the method of scaling is done by the setting of the scaling type definition bits in the scaling-method parameters.

3.3.1 Position data

Non-scaled position data

The position data, recorded by the drive and calculated by the control is transmitted in a non-scaled way between the controller and the drives (and converse) ([▶S-0-0076◀](#)). It is in the responsibility of the user to take into account the given significance at use of the position data.

Scaling of linear position data

The linear scaling is determined with the scaling type (see [▶S-0-0076◀](#)). The scaling parameters [▶S-0-0077◀](#) and [▶S-0-0078◀](#) are valid for all linear position data.

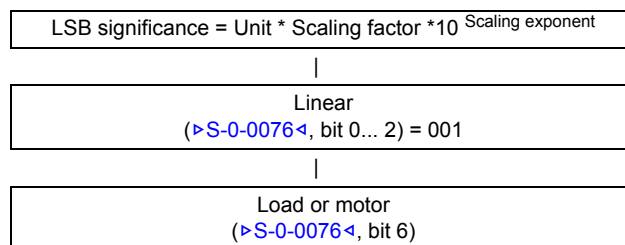

The LSB significance of the linear position data is defined by the scaling factor [▶S-0-0077◀](#) and the scaling exponent [▶S-0-0078◀](#).

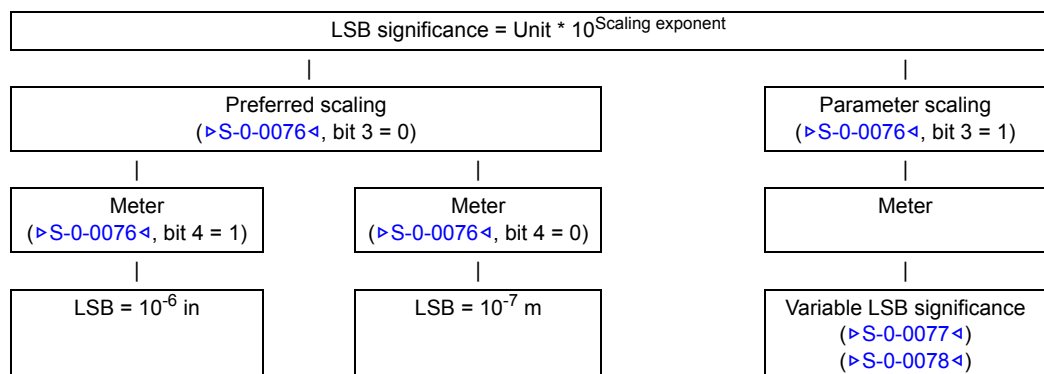

Scaling of rotary position data

The rotary scaling is determined with the scaling type (see [▶S-0-0076◀](#)). The rotary position resolution ([▶S-0-0079◀](#)) is valid for all rotary position data.

The LSB significance of the rotary position data is determined by the rotation position resolution.

$$\text{LSB significance} = \frac{1 \text{ revolution}}{\text{rotary position data}}$$

Preferred scaling for rotary position data

At rotary preferred scaling (see [▶S-0-0076◀](#)) the rotation position resolution ([▶S-0-0079◀](#)) is determined to 3600000. The LSB significance for all rotary position data therewith is 0.0001° (10⁻⁴ degree).

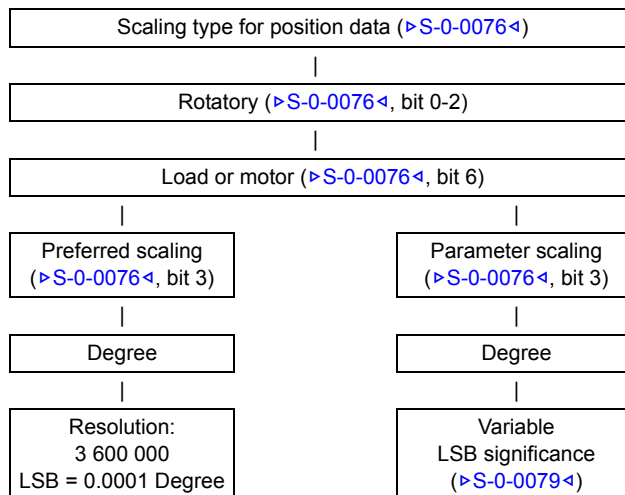

The relevant Sercos parameters are [▶S-0-0076◀](#), [▶S-0-0077◀](#), [▶S-0-0078◀](#), [▶S-0-0079◀](#) and [▶S-0-0103◀](#).

- S-0-0076** **Scaling type for position data** (also see parameter [▶S-0-0076◀](#))
 This parameter sets the scaling type for position data. It is defined, which format master and drive have to use for data exchange.
 The b maXX controller supports incremental, linear and rotatory scaling.
- S-0-0077** **Scaling factor of linear position data** (also see parameter [▶S-0-0077◀](#))
 In this parameter the scaling factor for all position data in this drive is set.
- S-0-0078** **Scaling exponent linear position data** (also see parameter [▶S-0-0078◀](#))
 In this parameter the scaling exponent for all position data in this drive is set.
- S-0-0079** **Rotary position resolution** (also see parameter [▶S-0-0079◀](#))
 This parameter contains the value of the rotary position resolution and determines the LSB value of the rotary scaling. If preferred scaling has been selected the value is 3600000. This means a LSB value of 0.0001 degrees.
- S-0-0103** **Modulo value** (also see parameter [▶S-0-0103◀](#))
 If in [▶S-0-0076◀](#) the modulo format has been selected, this parameter determines, when the position data are 0.
 If the modulo calculation is used, in this parameter it is to be entered with integer multiples of the rotation position resolution [▶S-0-0079◀](#).

3.3.2 Speed data

Non-scaled speed data

The speed data, recorded by the drive and calculated by the control is transmitted in a non-scaled way between the controller and the drives (and converse). It is in the responsibility of the user to take into account the given significance at use of the position data.

Scaling of speed data

The linear or rotatory scaling is set via the scaling type (see [▷S-0-0044◀](#) bit 0-2). The scaling parameters [▷S-0-0045◀](#) and [▷S-0-0046◀](#) are valid for all scaled speed data.

The LSB significance of rotatory speed data is determined by the product of scaling factor and scaling exponent (base 10).

$$\text{LSB significance} = \frac{\text{unit}}{\text{time unit}} \cdot \text{factor} \cdot 10^{\text{exponent}}$$

Preferred scaling of speed data

The preferred scaling is activated via [▷S-0-0044◀](#) bit 3 = 1.

Scaling type ▷S-0-0044◀ bit 0 - 2	Unit ▷S-0-0044◀ bit 5	Factor ▷S-0-0045◀	Exponent ▷S-0-0046◀	LSB
linear	m/min	1	-6	0.001 mm/min
linear	in/mm	1	-5	0.000 01 in/min
rotatory	min ⁻¹	1	-4	0.000 1 min ⁻¹
rotatory	s ⁻¹	1	-6	0.000 001 s ⁻¹

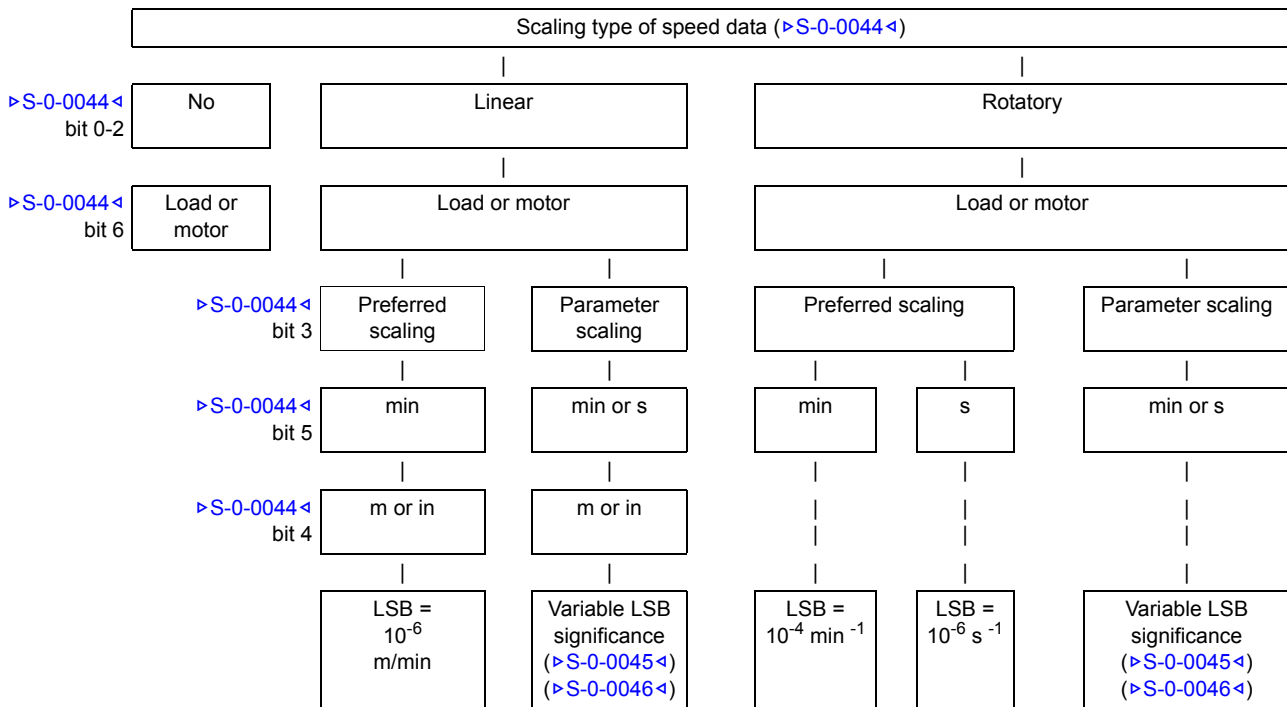

The relevant Sercos parameters are [S-0-0044](#), [S-0-0045](#) and [S-0-0046](#).

S-0-0044 **Scaling type for speed data** (see [S-0-0044](#))

With these parameters the method of scaling for speed data is selected. It is defined, which format master and drive have to use for data exchange.

The b maXX controller supports incremental, linear and rotatory scaling.

S-0-0045 **Scaling factor for speed data** (see [S-0-0045](#))

With this parameter the scaling factor for speed data is determined.

In case of preferred scaling the parameter is set to 1.

S-0-0046 **Scaling exponent for speed data** (see [S-0-0046](#))

This parameter determines the scaling exponent for speed data.

3.3.3 Acceleration and jerk data

Non-scaled acceleration/jerk data

The acceleration data, recorded by the drive and calculated by the control is transmitted in a non-scaled way between the controller and the drives (and converse). It is in the responsibility of the user to take into account the given significance at use of the acceleration data.

Scaled acceleration/jerk data

The linear or rotatory scaling is set via the scaling type (see [▷S-0-0160◀](#), bit 0-2). The scaling parameters [▷S-0-0161◀](#) and [▷S-0-0162◀](#) are valid for all scaled acceleration/jerk data.

The LSB significance is determined by the product of scaling factor and scaling exponent (base 10).

$$\text{LSB significance} = \frac{\text{unit}}{\text{time}^2} \cdot \text{factor} \cdot 10^{\text{exponent}}$$

Preferred scaling

Preferred scaling is activated via [▷S-0-0160◀](#) bit 3 = 1.

Scaling type ▷S-0-0160◀ bit 0 - 2	Unit ▷S-0-0160◀ bit 5	Factor ▷S-0-0161◀	Exponent ▷S-0-0162◀	LSB
linear acceleration	m/s ²	1	-6	0.000 001 m/s ²
linear jerk	m/s ³	1	-6	0.000 001 m/s ³
rotatory acceleration	rad/s ²	1	-3	0.001 rad/s ²
rotatory jerk	rad/s ³	1	-3	0.001 rad/s ³

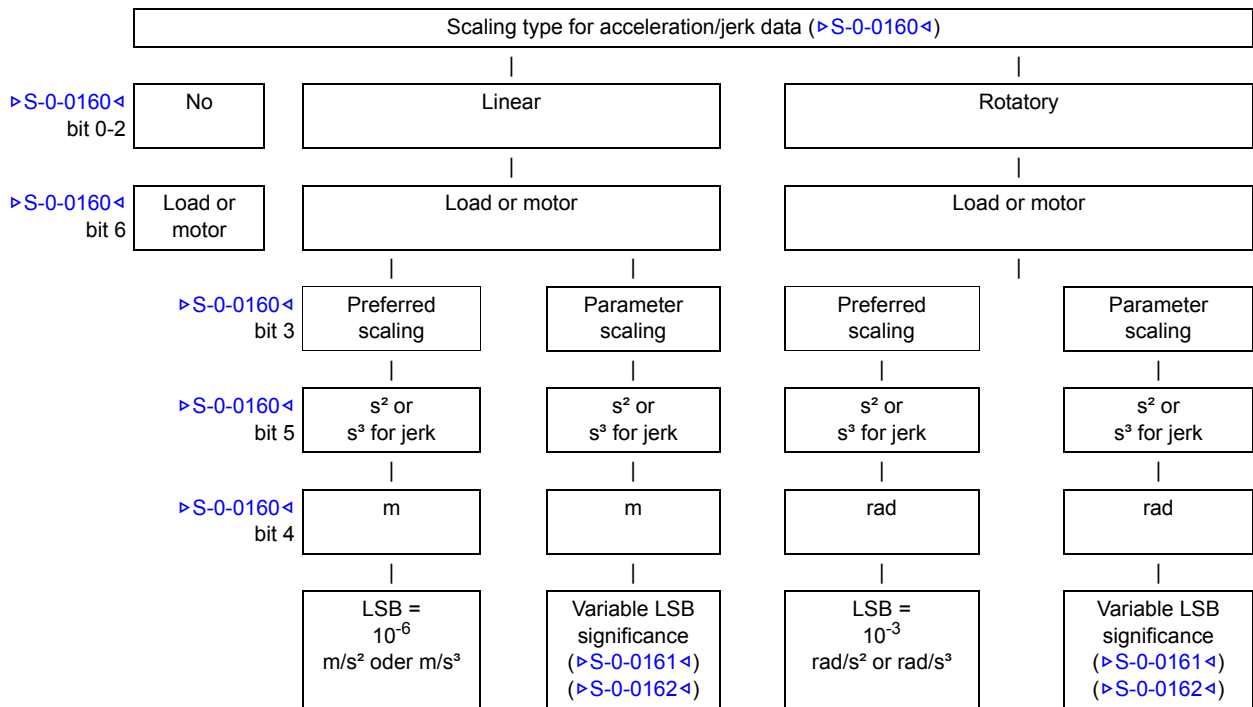

The relevant Sercos parameter are [>S-0-0160<](#), [>S-0-0161<](#) and [>S-0-0162<](#).

S-0-0160

Scaling type for acceleration data (see [>S-0-0160<](#))

This parameter sets the scaling type for acceleration data. It is defined, which format master and drive have to use for data exchange.

S-0-0161

Scaling factor for acceleration data (see [>S-0-0161<](#))

With this parameter the scaling factor for acceleration data is set.

In case of preferred scaling the parameter is set to 1.

S-0-0162

Scaling exponent for acceleration data (see [>S-0-0162<](#))

With this parameter the scaling exponent for acceleration data is set.

3.3.4 Torque and force data

Percentage scaling of torque and force data

The percentage scaling is set via scaling type ([▷S-0-0086◀](#)).

Scaling type ▷S-0-0086◀ bit 0 - 2	Unit	Factor ▷S-0-0093◀	Exponent ▷S-0-0094◀	LSB
linear	%	not relevant	not relevant	is not supported
rotatory	%	not relevant	not relevant	0.1 % of ▷S-0-0196◀ nominal current

Scaling of linear torque data

The scaling is set via scaling type ([▷S-0-0086◀](#)). The scaling parameters ([▷S-0-0093◀](#) and [▷S-0-0094◀](#)) are valid for all torque data.

The LSB significance of torque data is determined by the product of scaling factor and scaling exponent (base 10).

$$\text{LSB significance} = \text{unit} \cdot \text{factor} \cdot 10^{\text{exponent}}$$

Preferred scaling

The preferred scaling is activated via [▷S-0-0086◀](#) bit 3 = 1.

Scaling Type ▷S-0-0086◀ bit 0 - 2	Unit ▷S-0-0086◀ bit 5	Factor ▷S-0-0093◀	Exponent ▷S-0-0094◀	LSB
linear	N	1	0	1 N
linear	lbf ¹⁾	1	-1	0.1 lbf
rotatory	Nm	1	-2	0.01 Nm
rotatory	in lbf ²⁾	1	-1	0.1 in lbf

1) 1 N = 0.22481 lbf

2) 1 Nm = 8.851 in lbf

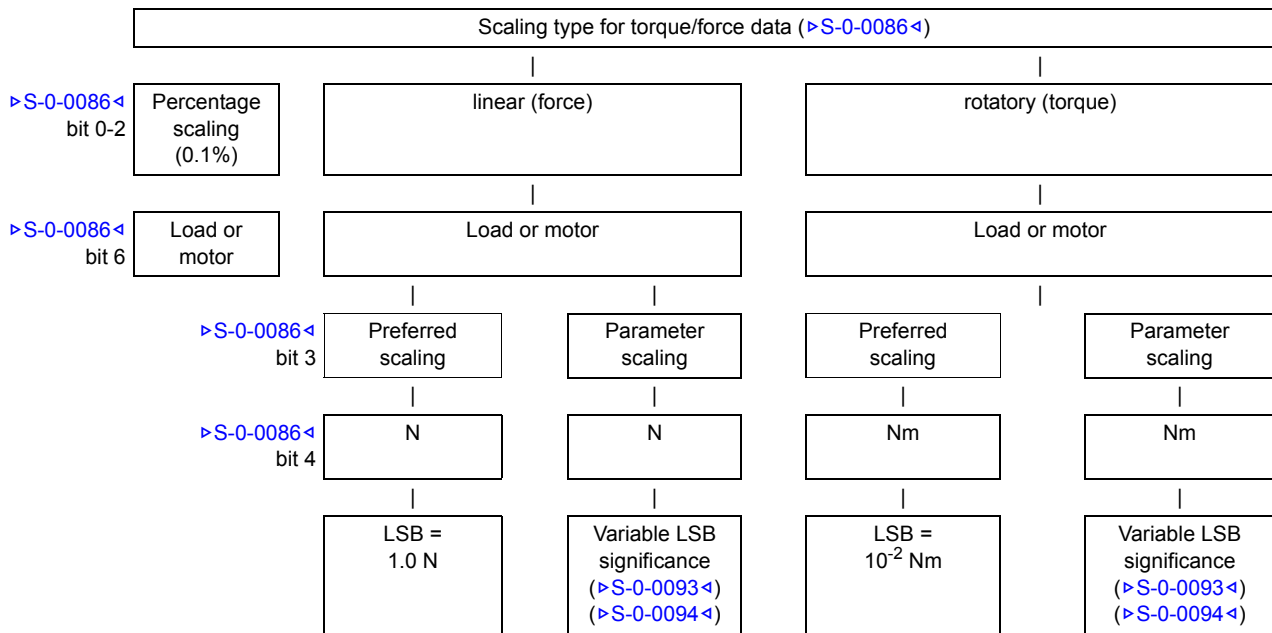

The relevant Sercos parameters are [>S-0-0086<](#), [>S-0-0093<](#) and [>S-0-0094<](#).

S-0-0086 **Scaling type for torque data** (see [>S-0-0086<](#))

This parameter sets the scaling type for torque data. It is defined, which format master and drive have to use for data exchange.

S-0-0093 **Scaling factor torque data** (see [>S-0-0093<](#))

This parameter sets the scaling factor for torque data.
In case of preferred scaling the parameter is set to 1.

S-0-0094 **Scaling exponent torque data** (see [>S-0-0094<](#))

This parameter sets the scaling exponent for torque data.

DATA EXCHANGE AND PARAMETRIZATION

4.1 Data contents

The following terms are used:

- **Operation data**
All data which is used is to be provided with parameter numbers (IDN) and is to be referred to as operating data.
- **Parameters**
Parameters are used for the setting of drives and for the control, in order to guarantee an error-free operation of the system.
- **Commands**
The commands are used, in order to activate functions in the drives or between the control and the drives.
- **Set values and actual values**
Set and actual values normally are integrated as cyclic data into the telegrams.

4.1.1 Data terms

- **Service data**
Service data are exchanged on request over the service channel between the control and the drives. Such a service case is for example the display or input of certain data to the control terminal.
So that, if required, all data is to be displayed or is to be set in any kind of way at the control terminal, basically all data can be read as service data and is able to be written as the same.
For commissioning or service the taking over of cyclic data should be inhibited. There-with the data which have been normally transferred cyclically can be written as service data.

- **Cyclic data**
Data are designated as cyclic data if they are in a configurable data record of the telegrams and therewith are transmitted anew in each communication cycle.
In this communication phase 2 it is determined, which data is transmitted cyclic from the control to each single drive and which data the control receives from each single drive.
Set and actual values in general are defined as cyclic data.
- **Initialization data**
This data initializes the communication system and determine all drive parameters of the control and of the drives.

4.2 Communication parameters

The communication parameters are used for the coordination between the master and the slave. The temporal action of communication is determined with these. Communication parameters must be transmitted during communication phase 2 (CP2) and activated during communication phase 3 (CP3) in both the master and the slave (also see [►Standard parameters◄](#) from page 61).

4.2.1 EtherCAT SoE

The drive synchronization is done via „Distributed Clocks“ in the current implementation. Due to the different physics of EtherCAT and Sercos the following parameters from Sercos standard are not necessary using a EtherCAT link and therewith are not supported: S-0-0003, S-0-0004, S-0-0005, S-0-0009, S-0-010, S-0-0088, S-0-090
Due to the modified physics the following parameters also have a modified meaning compared with the Sercos standard

IDN	EtherCAT	Sercos
►S-0-0006◄	Indicates the time as offset to the EtherCAT synchronization, at which the drive must provide the actual values (not implemented yet)	Transmission starting time AT (t1)
►S-0-0028◄	Counts the failed telegrams in the cyclical operation	MST error counter
►S-0-0089◄	Specifies time as offset to EtherCAT synchronization, were the drive shall start to evaluate the set values (not implemented yet)	MDT transmission starting time (T2)

4.3 Telegram

Sercos describes a data set as telegram, which cyclical is transferred between master and slave. This meaning is also used when using SoE via EtherCAT.

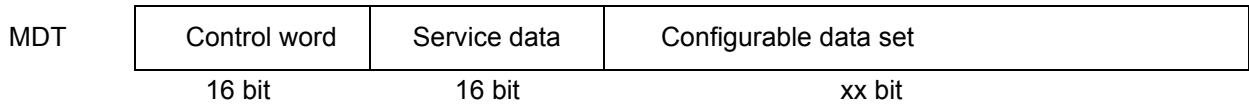

Figure 5: General form of a master data telegram (MDT)

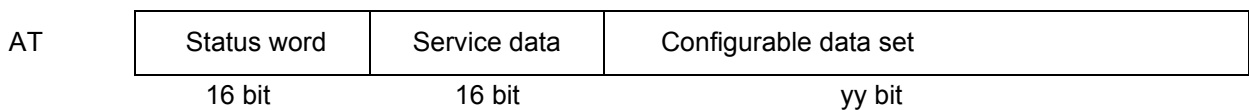

Figure 6: General form of response telegram (AT)

The telegram contents of the configurable data sets are determined either by predefined (standard) or freely configurable telegrams. This determination operates via the telegram type [▶S-0-0015◀](#).

All actual values, which are contained in the drive telegram must be updated in each cycle during communication phase 4 by the drive. In the MDT the set values to be transmitted cyclically must remain valid in CP4 depending on the operation mode.

Telegram types

Telegram type	MDT	AT	Suitable for
▶S-0-0015◀	▶S-0-0134◀ Master control word + set values	▶S-0-0135◀ Drive state + actual values	P-0-0320 set operation modes of b maXX controller
0	---	---	
1	▶S-0-0080◀ torque set value	---	-2 = torque control -1 = finding notch position
2	▶S-0-0036◀ speed set value	▶S-0-0040◀ speed actual value 1	-3 = speed control -1 = finding notch position
3	▶S-0-0036◀ speed set value	▶S-0-0051◀ position actual value 1 or ▶S-0-0053◀ position actual value 2	-3 = speed control -1 = finding notch position
4	▶S-0-0047◀ position set value	▶S-0-0051◀ position actual value 1 or ▶S-0-0053◀ position actual value 2	-4 = position control -1 = finding notch position 6 = homing
5	▶S-0-0047◀ position set value ▶S-0-0036◀ speed set value	▶S-0-0051◀ position actual value 1 or ▶S-0-0053◀ position actual value 2 ▶S-0-0040◀ speed actual value 1	-3 = speed control -4 = position control -1 = finding notch position 6 = homing
6	▶S-0-0036◀ speed set value	---	-3 = speed control -1 = finding notch position
7	Configurable via ▶S-0-0024◀	Configurable via ▶S-0-0016◀	Dependent on configuration

4.4 Configuration parameters of the controller

Specific settings can be saved in the controller data set. These are configuration settings, which could not be set by IDN, or have to be valid when switching on the device (before any fieldbus communication).

In **P-0-1016** Configuration profile 1 settings can be done via service data communication. Another possibility is the setting via parameter list of ProDrive. In ProDrive the controller parameter No. 131.021.0.0 corresponds with the Sercos-IDN **P-0-1016**.

The parameter is not assigned to an axis, i. e. using a double axis, only one value can be set for both axes.

Configuration profile 1 bit No.	Meaning
0	Info about phase transition in ▷S-0-0095◀ and ▷S-0-0375◀ 0: output 1: no output
1	0: standard scaling according parameter list 1: different scaling (no decimal place of scaling data, change in scaling when ▷S-0-0046◀ = -3; ▷S-0-0078◀ = -1)
2	Reserved
3	1: activation of function „Relative modulo“
4	Drive enable 0: bit 14 and 15 of ▷S-0-0134◀ Master control word is evaluated. 1: only bit 15 of ▷S-0-0134◀ Master control word is evaluated, bit 14 is ignored
5	Option command 262 „Load default values“: 0: Loading of default values in the active data set of the working memory (RAM). 1: Loading of default values, in addition deletion of all parameter sets in the flash memory and storing of the default values in parameter set 0 of the flash memory.
6	Option command 263 „Load working memory“ and 264 „Backup working memory“ 0: Stored or loaded are S parameters of the IDN list ▷S-0-0192◀ , S parameters with P parameter allocation and P parameters 1: Stored or loaded are S parameters of the IDN list ▷S-0-0192◀ only
7	FW01.09 and higher 1: The set value cycle of the controller is not set to the value of ▷S-0-0001◀ NC cycle time while changing from PreOp ⇒ SafeOp
8	1: activation of special treatment when reading ▷S-0-0047◀
9 to 31	Reserved

CONFIGURATION OPTIONS OF FIELDBUS SLAVE

The behavior of the fieldbus slave can be changed by modifying the slave settings in controller parameter **P131.9** (=Sercos P-0-1004).

Only the bit 0 of this parameter is evaluated by SoE.



NOTE!

Changed settings result in a change in behavior!

5.1 Network settings for EoE (Ethernet over EtherCAT)

In case of Ethernet communication to EtherCAT slaves the TCP packets are transmitted within the EtherCAT packets (tunneling). This is used for example for the communication between a b maXX controller with EtherCAT slave and the operating tool ProDrive®.

In this case for every EtherCAT slave an unique IP address must be set. The EtherCAT slave is identified as Ethernet participant via this IP address.

Setting of the IP address:

- o 192.168.XXX.XXX
- o 192.168 cannot be changed

XXX represents the setting of the DIP switches on the front side of the device or the b maXX parameter. DIP switch or b maXX parameter is selected via bit 0 of parameter slave settings.

Slave settings (P131.9, Sercos P-0-1004)

Bit 0 = 0 IP address = Basis IP address (P131.12, Sercos P-0-1007) + DIP switch (P131.13, Sercos P-0-1008),
Sub net mask = 255.255.0.0

Bit 0 = 1 Readout the net work settings for EoE of b maXX parameters:
Software IP address (P131.14, Sercos P-0-1009),
Gateway (P131.16, Sercos P-0-1011)
and sub net mask (P131.17, Sercos P-0-1012)

An EtherCAT master can change the IP address if the master provides this function. Then any IP address is possible.

The port No. for the communication is 5043_{hex} (= 20547_{dez}).

6

OPERATION MODES

6.1 General information

The operation mode determines the drive controlling. The b maXX controller supports one main operation mode ([▶S-0-0032◀](#)) and 3 additional operation modes ([▶S-0-0033◀](#), [▶S-0-0034◀](#), [▶S-0-0035◀](#)).

The specification of an operating mode is made via bits 8 and 9 of the Sercos control word [▶S-0-0134◀](#). The active operation mode is displayed in bit 8 and 9 of the Sercos status word [▶S-0-0135◀](#).

6.2 Operation mode parameters

The operation mode parameters are configured in identical form. The following table provides a survey of the operating modes, which are supported by SoE:

Bit-No.	15	14 - 10	9	8	7 - 4	3	2 - 0	Display at ▷S-0-0292◀	Operation mode	Set operation mode P-0-0320
	0	000 00	0	0	0000	0	000		No	No
	0	000 00	0	0	0000	0	001	0x0001	Torque control	-2
	0	000 00	0	0	0000	0	010	0x0002	Speed control	-3
	0	000 00	0	0	0000	X	011	0x0003	Position control with encoder 1	-4
	0	000 00	0	0	0000	X	100	0x0004	Position control with encoder 2	-4
	0	000 00	0	0	0000	X	101	0x0005	Position control with encoder 1 and 2	-4
	0	000 00	0	0	0001	X	011	0x0013	Drive internal interpolation, encoder 1	1

								Manufacturer specific operation mode (bit 15 = 1)		
	1	000 00	0	0	0000	0	000	Invalid	0	
	1	000 00	0	0	0000	0	001	0x8001	Synchronous operation	-5
	1	000 00	0	0	0000	0	010	0x8002	Finding notch position	-1
	1	000 00	0	0	0000	0	011	0x8003	Position target input	1
	1	000 00	0	0	0000	0	100	0x8004	Speed setting 1	2
	1	000 00	0	0	0000	0	101	0x8005	Jogging mode, position controlled	5
	1	000 00	0	0	0000	0	111	0x8007	Homing, drive controlled	6

Note:

- Bit 3 is not supported. A position controlled operation without deviation error is already activated at the b maxx controller with a standard value of 100 % in parameter speed feedforward (S-0-0296). An operation with deviation error is activated by switching-off this feedforward control (▷S-0-0296◀ = 0 %).

- The supported switching-over via bit 8 is currently without function. A „flying“ change with speed synchronization (smooth, i. e. without speed step) must be activated via a modus P parameter of the controller operation mode.

Change in operation mode	P-0-0320	Activate speed synchronization
Speed control	-3	P-0-0331 mode Bit 6 = 0
Position control with encoder 1 and 2	-4	P-0-0511 mode Bit 0 = 1
Drive internal interpolation, position target input	1	P-0-0611 mode Bit 0 = 1
Synchronous mode	-5	P-0-0541 mode Bit 8 = 1
Speed setting 1	2	P-0-0331 mode Bit 6 = 0
Jogging mode	5	P-0-0501 mode Bit 0 = 1
Homing, drive controlled	6	P-0-0641 mode Bit 0 = 1

- Bit 9 is not supported in combination with S-0-0520 Axis control word.
- Bits 10 to 14 are reserved and must be set to 0.



COMMANDS

A command is activated by writing on the accordant command parameter.

7.1 General information



NOTE!

Only one active command is permitted at any time. It is not permitted to enable two commands at the same time.

The command parameter only uses bit 0 and bit 1.

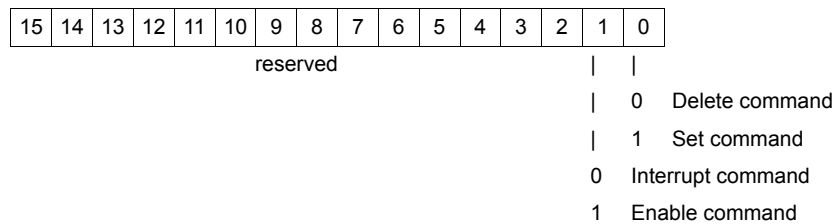

7.2 Supported commands

The command response via service channel is shown below (only bits 0 to 3 are evaluated).

15	14	13	12	11	10	9	8	7	6	5	4	3	2	1	0	
Reserved																
															0	Command is not set
															1	Command is set
														0	Command is interrupted	
														1	Command is enabled	
													0	Command is completed		
													1	Command is not completed		
												0	Command without error			
												1	Command execution is not possible			

7.2 Supported commands

The following commands are supported (also see [▷S-0-0025◀](#)):.

Command	IDN	Independent of axis ¹⁾	Parallel ²⁾	Notes
Reset class 1 diagnostic	▷S-0-0099◀		X	
Transition check CP3	▷S-0-0127◀	X		When using SoE the parameter ▷S-0-0127◀ is displayed only, the parameter does not activate the command.
Transition check CP4	▷S-0-0128◀	X		When using SoE the parameter ▷S-0-0128◀ is displayed only, the parameter does not activate the command.
Parking axis	▷S-0-0139◀		X	
Control unit controlled homing	▷S-0-0146◀			Double axis: cannot be executed parallel, because hardware resources (touch probe) can be used by both axes.
Drive controlled homing	▷S-0-0148◀		X	
Spindle positioning	▷S-0-0152◀		X	
Touch probe	▷S-0-0170◀			Double axis: cannot be executed parallel, because hardware resources (touch probe) can be used by both axes.
Calculate displacement	▷S-0-0171◀		X	
Displace to the referenced system	▷S-0-0172◀		X	
Set system coordinates	▷S-0-0197◀		X	
Load defaults	▷S-0-0262◀	X		Command start only via axis 1. ³⁾
Load working memory	▷S-0-0263◀	X		
Backup working memory	▷S-0-0264◀	X		

¹⁾ **Independent of axis** = in case of double axis, the command is always executed for both axes

²⁾ **Parallel** = in case of double axis, it is possible to execute the command for both axes

³⁾ **Axis 1** = is the first axis of a double axis and is addressed with drive No. 0 via service data.

7.3 Allocation of realtime bits

As commands use the non-cyclic data exchange (service channel communication) it needs a non-predictable time until the master is informed via the command procedure. Similar is valid for the enable of actions in the slave.

That is why two realtime status bits can be used for the binary status information.

Bit 6 of the Sercos status word is the realtime status bit 1.

Bit 7 of the Sercos status word is the realtime status bit 2.

For the enable of actions in the drive two realtime control bits can be used. Only IDNs with no write-protection in phase 4 can be configured.

Bit 6 of the Sercos control word is realtime control bit 1.

Bit 7 of the Sercos control word is realtime control bit 2.

The realtime bits are cyclically transmitted.

Four S-parameter numbers are defined, to which one of the realtime bits individually are assigned.

- ▷S-0-0301◁ Allocation of realtime control bit 1
- ▷S-0-0303◁ Allocation of realtime control bit 2
- ▷S-0-0305◁ Allocation of realtime control bit 1
- ▷S-0-0307◁ Allocation of realtime control bit 2

These S-parameters contain a S-parameter number of a binary signal. This makes an assignment of the realtime bits to the binary signals possible.



NOTE!

Parameters **S-0-0413** to **S-0-0416** are not supported.

Example:

Allocation of a parameter number not equal 0 according to a realtime bit, if according to this realtime bit there is no other allocation active.

The status of the realtime control bits must at the latest be defined, if the element 7 of ▷S-0-0301◁/▷S-0-0303◁ is written.

It is ensured, that a valid status is provided if the service channel response is „no error“.

The evaluation of the realtime control bit is started by the drive before the response of writing (▷S-0-0261◁/▷S-0-0303◁) at service channel is generated.

The evaluation of the realtime control bit must not be started at the master before the drive finished evaluation of response of writing (▷S-0-0305◁/▷S-0-0307◁).



NOTE!

The handshake between slave and master is not supported by SoE while the allocation of realtime bits is active. Here the control word bit 1 and the status word bit 0 (drive handshake AHS) and bit 1 (busy bit) is not used or with another function allocated.

Realtime status bits:

- The status of the accordant realtime status bit of the master is considered as undefined immediately when writing the allocation parameter on IDN = 0 (switch-off)
- The status of the accordant realtime status bit of the master is considered as defined when writing the allocation parameter on IDN \neq 0 (switch-on) in case a positive feedback via service channel is received. In error case (e.g. not permitted parameter) the realtime bit remains switched-off.
- In case of re-parametrization (former IDN \neq 0) the status of the accordant realtime status bit is invalid immediately when writing the allocation parameter on the new IDN. The new parametrization of the realtime bits is valid as soon as a positive feedback via service channel is received. In error case (e.g. not permitted parameter) the original parametrization remains unchanged.

Realtime control bits:

- The realtime evaluation is stopped when writing on allocation parameter on IDN = 0 (switch-off). The master receives no feedback in status word whether the switch-off is executed. The switch-off is reported at the latest via service channel.
- At the earliest the parametrization is considered valid by the master when writing the allocation parameter on IDN \neq 0 (switch-on) in case a positive feedback via service channel is received.
- In case of re-parametrization (former IDN \neq 0) when writing the allocation parameter on the new IDN, the new parametrization is valid as soon as a positive feedback via service channel is received. In error case (e.g. not permitted parameter) this realtime bit is switched-off.

7.4 Homing

Homing can either be started by the control or by the drive. There are commands for both possibilities.

7.4.1 Command „Drive controlled homing“

The following requirements are valid:

- The position measuring system is connected to the drive, the position actual value processing is operated by the drive.
- The reference switch is directly connected to the drive.

Before the control initiates the „drive controlled homing“ by setting and enabling of the commands ([▶S-0-0148◀](#)), it must allocate the necessary control- and status signals via the service channel to the realtime bits.

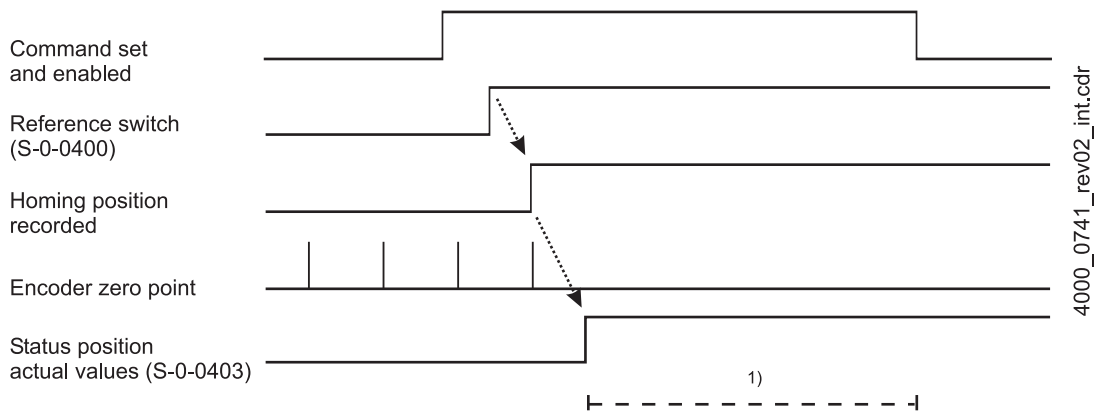

Figure 7: Bit string

1) During this time the control must take over the position set value ([▶S-0-0047◀](#)) from the drive.



NOTE!

The command change bit (bit 5 status word) is not used at SoE (see IEC 61800-7-304, chapter 7 mapping to EtherCAT).

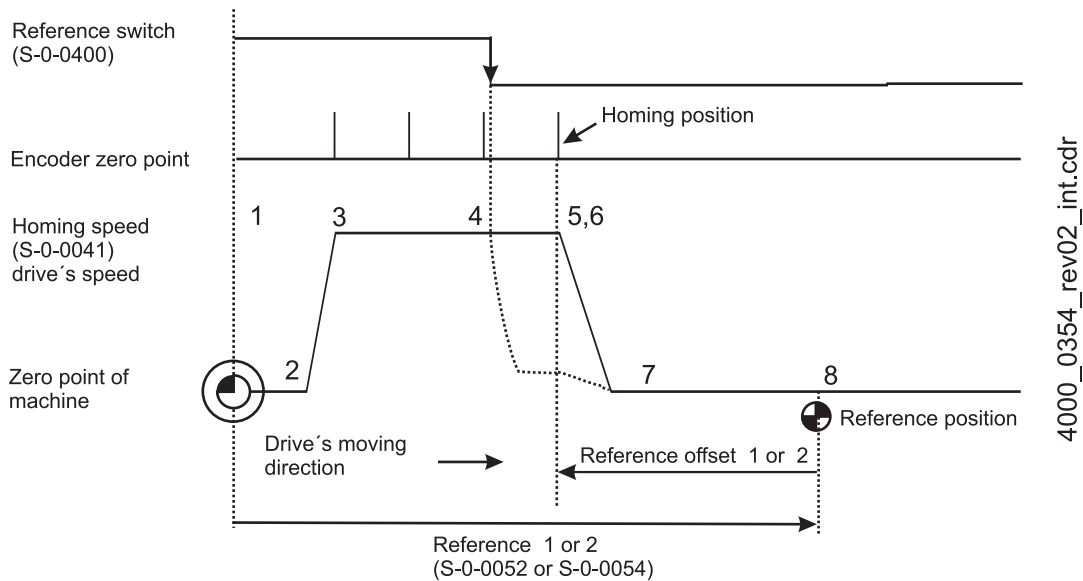

Figure 8: Drive controlled homing

- 1 The command „Drive controlled homing“ ([▶S-0-0148◀](#)) is set and enabled.
- 2 Starting point of the drive, which is not yet referenced to the zero point of machine. The drive switches to internal position control and deletes the bit „Status position actual values“ ([▶S-0-0403◀](#)).
- 3 With regard to the starting direction, determined by the homing parameter ([▶S-0-0147◀](#)) the drive accelerates by complying with the homing acceleration ([▶S-0-0042◀](#)) to the homing speed ([▶S-0-0041◀](#)).
- 4 With detection of the programmed signal change at the reference switch (programmed via the homing parameter [▶S-0-0148◀](#)) the drive finds the reference position with the encoder zero point. The drive can decelerate via an internal function the speed after recognizing the signal change at the reference switch (dash-lined).
- 5 The drive decelerates with the homing acceleration to a standstill.
- 6 The detection of the reference in the drive is followed by the setting of the position actual value 1 or 2. The position data signs must be regarded.
 Position actual value 1 = reference 1 + reference offset 1 + distance to homing position
 Position actual value 2 = reference 2 + reference offset 2 + distance to homing position
 As soon as the position actual value 1 or 2, which refers to the machine zero point was written into the drive telegram, the drive sets the [▶S-0-0403◀](#).
 The drive calculates a position set value, which is equal to the referenced position actual value 1 or 2. The control reads this position set value ([▶S-0-0047◀](#)) from the drive and sets its own position set value on this position.
- 7 After that the control deletes the command and the drive follows the set values of the control.
 The control doesn't generate new position set values (this means the axis remains near the position encoder homing position), later the control starts from this point.
- 8 Reference position of the axis. The control uses the same procedure for all further drives.

7.4.2 Homing by the control

At the control unit controlled homing there are three commands available:

- Control unit controlled homing (▶S-0-0146◀)
- Calculate displacement (▶S-0-0171◀)
- Displacement into reference system (▶S-0-0172◀)

These commands also can be used partly if for example the control calculates the displacement and then writes it into the drive.

7.4.2.1 Command „Control unit controlled homing“

For a proper sequence of the commands (▶S-0-0146◀) the following allocations according the realtime control- or status bits are necessary:

- Realtime control bit: Homing enable (▶S-0-0407◀)
- Realtime status bit: Reference position recorded (▶S-0-0408◀)

If the reference switch is connected to the drive additionally the following allocation is necessary:

- Realtime status bit: Reference switch (▶S-0-0400◀)

The allocations must be done before starting the command and can be checked by the drive.

At Control unit controlled homing it is distinguished between three cases:

Case 1

The reference switch is connected to the control, the drive only evaluates the signal „Homing enable“. (▶S-0-0147◀ bit 2 = 0).

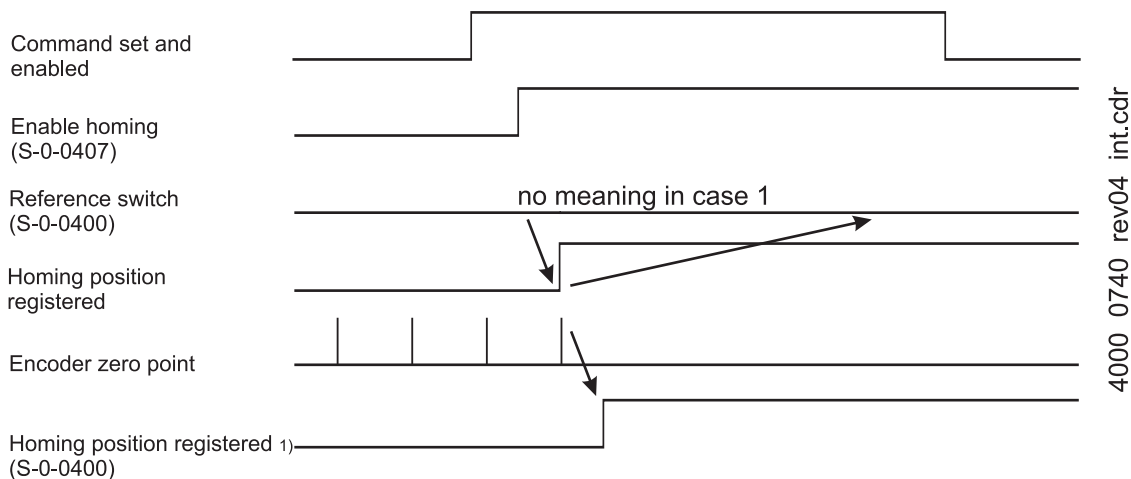

Figure 9: Bit sequence at Control unit controlled homing (case 1)

1) The ▶S-0-0408◀ is used in this case because the command change bit is not supported when using SoE.

- Case 2** The reference switch is connected to the drive (▶S-0-0147◀ bit 2 = 1).
- Case 2.1 The drive signals the control the reference switch (▶S-0-0400◀) via the realtime status bit 2.
The control sets the homing enable (▶S-0-0407◀) via the realtime control bit. The drive evaluates only the homing enable (▶S-0-0147◀, bit 4 = 1).

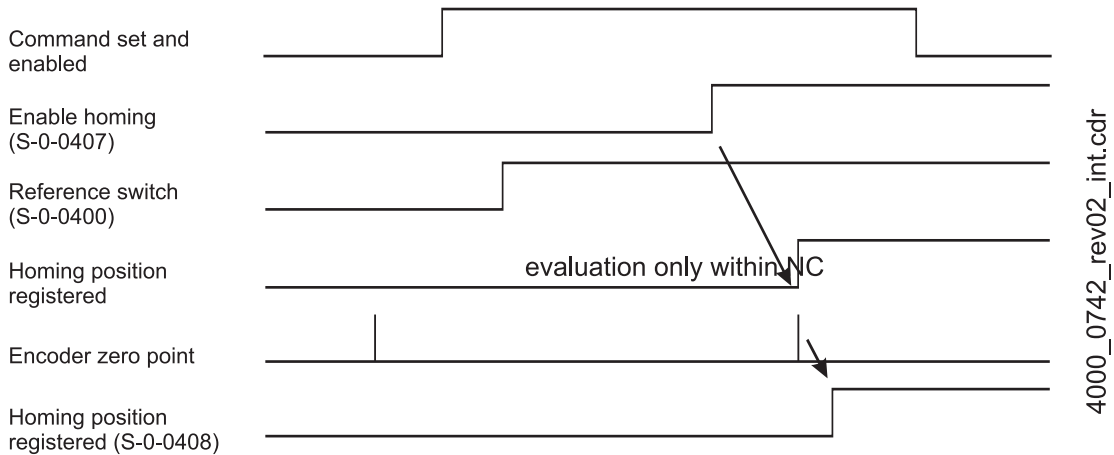

Figure 10: Bit sequence at Control unit controlled homing (case 2.1)

- Case 2.2 The drive signals the control the reference switch (▶S-0-0400◀) via the realtime status bit 2.
The control sets the homing enable (▶S-0-0407◀) via the realtime control bit. The drive evaluates the homing enable via the reference switch (▶S-0-0147◀, bit 4 = 0).

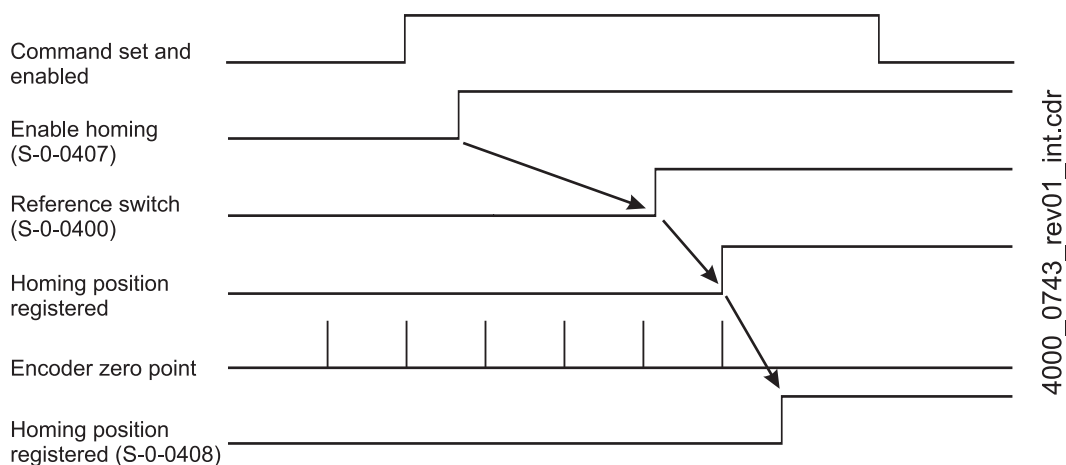
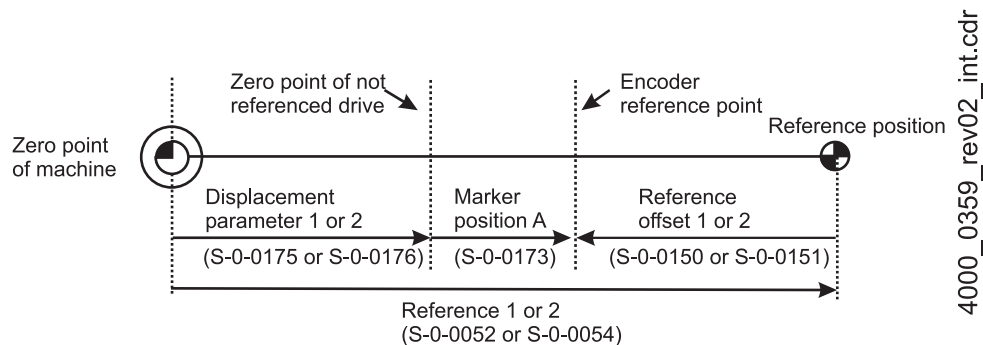

Figure 11: Bit sequence at Control unit-controlled homing (case 2.2)

7.4.2.2 Command „Calculate displacement“

In order to calculate the displacement of old and new measuring system (which refers to the machine zero point), two procedures are available:

- The drive calculates the displacement via the command „Calculate displacement“ ([▶S-0-0171◀](#)).
 - At an incremental measuring system:
 - At an incremental measuring system:
 - Distance from machine zero point = reference 1 ([▶S-0-0052◀](#))
 - Distance from machine zero point = reference 2 ([▶S-0-0054◀](#))
 - The signs depend on the configuration of the machine.
 - The drive calculates displacement between the machine zero point and the zero point of the non-referenced drive according to the following formula (under consideration of signs):
 - Displacement value 1 or 2 = distance to the machine zero point - marker position A ([▶S-0-0173◀](#)).
 - The result is saved in the displacement parameter 1 or 2 ([▶S-0-0175◀](#) or [▶S-0-0176◀](#)).
 - The drive accepts the command positive as soon as the displacement has been calculated and saved.
 - The master control reads the displacement parameter 1 or 2 ([▶S-0-0175◀](#) or [▶S-0-0176◀](#)) from the drive and sets the position set value on the referenced system.
 - The master control deletes the command „Calculate displacement“.
-
- The master control calculates displacement (without command procedure).
 - The master control reads the data, which is required for the calculation from the drive.
 - The master control calculates displacement:
 - Displacement 1 or 2 = distance to the machine zero point - marker position A ([▶S-0-0173◀](#))
 - The master control programs the displacement parameter 1 or 2 ([▶S-0-0175◀](#) or [▶S-0-0176◀](#)) in the drive.



S-0-0150 / S-0-0151 are currently not supported

Figure 12: Incremental measuring system

7.4.2.3 Command „Displacement in reference system“

For the correct function of the command „Displacement in reference system“ ([▶S-0-0172◀](#)) the following allocations of the realtime bits are required:

- ▶ Realtime control bit: Status position set value ([▶S-0-0404◀](#))
- ▶ Realtime status bit: Status position actual value ([▶S-0-0403◀](#))

Simultaneously, the position set values are switched over to the referenced system with the setting of realtime control bits „Status position set values“. Simultaneously, with the entering of the referenced position actual value 1 or 2 in the AT, the realtime status bit „Status position actual value“ ([▶S-0-0403◀](#)) is set (the position actual values refer to the home position).

After both bits were set, the drive accepts the command as positive. The correct order, in which the bits must be set, is not determined.

The bit status position set values must be set by the control independently from the operation mode.

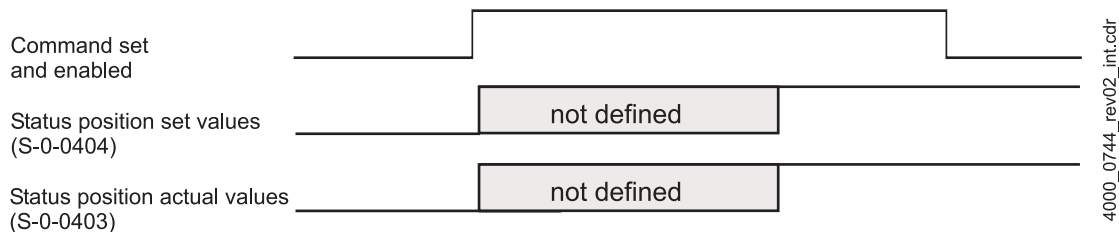

Figure 13: Bit sequence during execution of displacement

7.5 Touch probe

The command „Touch probe“ acts as a function in order to activate the function „Measurement with probe“ (▶S-0-0170◀). With this command not only a single measurement but also a multiple measurement (usage of realtime bits) is possible.

The setting and enable of a command activates the function „Touch probe“ in the drive. The drive signals this by the setting of the acknowledgement command (data status) „set, enabled, not executed yet“. An acknowledge „Execute command properly“ is not made. This means, that the command change bit is only set in the error case.

Using the „Touch probe parameter“ (▶S-0-0169◀) specific edges of probe 1 and 2 can be selected.

Using the „Probe control parameter“ (▶S-0-0169◀) specific edges of probe 1 and 2 can be selected.

Due to the signals „Probe-1 or -2-enable“ (▶S-0-0405◀ or ▶S-0-0406◀) measuring is enabled.

With the occurring of the selected edge at the probe the drive saves the position actual value in the according parameter ▶S-0-0130◀ to ▶S-0-0133◀ (probe value 1 or 2, positive or negative edge) and sets the according bit in the probe status (▶S-0-0179◀). The status bits in the probe status are addressed via the parameter number ▶S-0-0409◀ to ▶S-0-0412◀ and therewith can, at quick measurements, be allocated to the realtime status bits.

If an active measurement edge occurs, the effects of a equal edge are inhibited. This inhibit is deleted by reset of „Probe-1 or 2-enable“ (▶S-0-0405◀ or ▶S-0-0406◀) again. Then, by the setting of „Probe-1 or 2-enable“ measurement is enabled again.

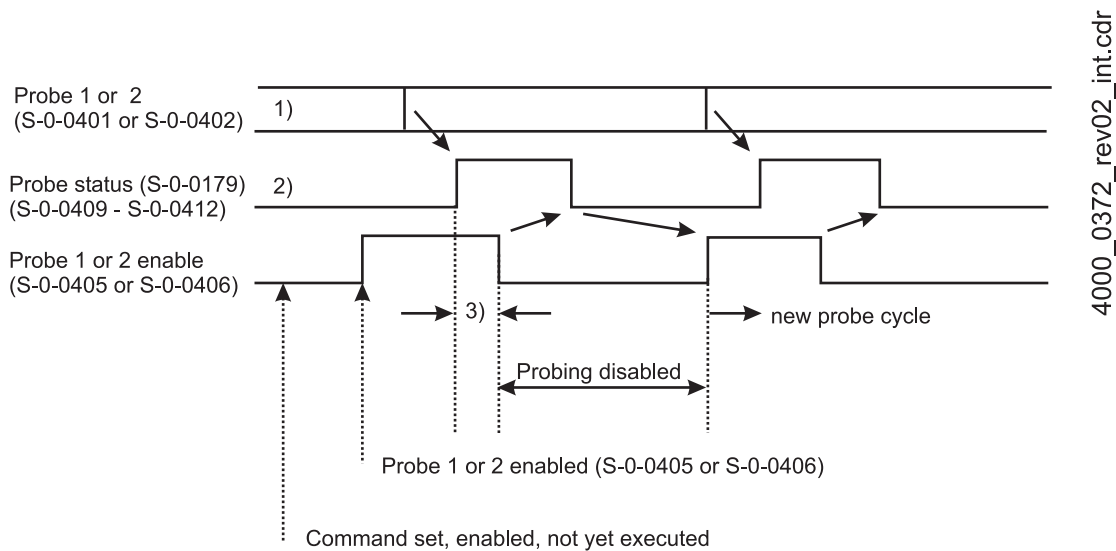

Figure 14: Bit sequence for command probe

- 1) Selection of probe 1 or 2 and the active edge is set via the probe control parameter (▶S-0-0169◀).
- 2) The bits probe value 1 or 2, positive/negative latched, are included in the parameter number ▶S-0-0179◀. These bits have the parameter numbers ▶S-0-0409◀ to ▶S-0-0412◀.
- 3) In this time sequence normally the probe value 1 or 2 positive/negative (▶S-0-0130◀ to ▶S-0-0133◀) is read.

7.5.1 Command probe cycle

For example probe 1 is activated:

- At first the realtime status bits must be allocated:
 e. g. `>S-0-0305<` is set to 409 (value latched to positive edge of the probe) and `>S-0-0307<` is set to 410 (value latched to negative edge of the probe).
 This way it is possible to monitor the status of the probe with the realtime status bits
 Then it must be determined, which edge of the probe signal is used in order to read the values. This is determined in `>S-0-0169<` with the bits 0 to 3.

15	14	13	12	11	10	9	8	7	6	5	4	3	2	1	0	
Reserved																
															0	Probe 1 pos. edge inactive
															1	Probe 1 pos. edge active
														0	Probe 1 neg. edge inactive	
														1	Probe 1 neg. edge active	
													0	Probe 2 pos. edge inactive		
													1	Probe 2 pos. edge active		
												0	Probe 2 neg. edge inactive			
												1	Probe 2 neg. edge active			

- Command „Enable probe“ by setting bit 0 and 1 of `>S-0-0170<` (`>S-0-0170<` = `0003hex`).

- Finally the probe is activated by setting `>S-0-0405<` = 1 (probe 1 is enable).

If a value once has been read during a probe cycle a new measuring is prevented until `>S-0-0405<` has been reset and set again.

Probe values of the positive edges are written to `>S-0-0130<` and probe values of negative edges are written to `>S-0-0131<`.

The probe command is completed with `>S-0-0170<` = `0000hex`.

NOTE!

A reset of measured values in case of deactivation (`>S-0-0405<` = 0) can be set in P-0-0700 Configuration mode bit 30 = 1.

7.6 Parking axis

The following operating sequence is determined for the command [▶S-0-0139◀](#) Parking axis:

The command [▶S-0-0139◀](#) is set by the control via the service channel and is enabled.

In the drive the monitoring of the encoder system is switched off.

Then the bit „Status position actual value is reset and the change of command bit is set by the drive. Therewith the controller detects, that the command was executed.

The command is deleted. Therewith monitoring is reactivated.

**NOTE!**

The command change bit is not used at EtherCAT in drive status ([▶S-0-0135◀](#) bit 5).
When resetting the command an error reset is executed.

7.7 Command Spindle positioning

The command Spindle positioning ([▶S-0-0152◀](#)) positions a spindle on an absolute angle or turn a spindle for a relative angle.

The function is activated in the drive by the setting and enabling of the command. The drive accepts the activation by the setting of command status to „Command set, activated and not executed yet“. There is no confirmation „Command executed“.

The positioning mode of the spindle is set in the positioning parameter ([▶S-0-0154◀](#)). At positioning, this parameter defines, whether the spindle is positioned clockwise or counter-clockwise or on the quickest path. With this parameter it is furthermore determined, whether the positioning is executed with absolute or relative positioning.

7.7.1 Speed value > positioning speed

If the actual speed of the drive at activation of the command „Spindle positioning“ greater than the positioning speed ([▶S-0-0222◀](#)), then the drive brakes to positioning speed.

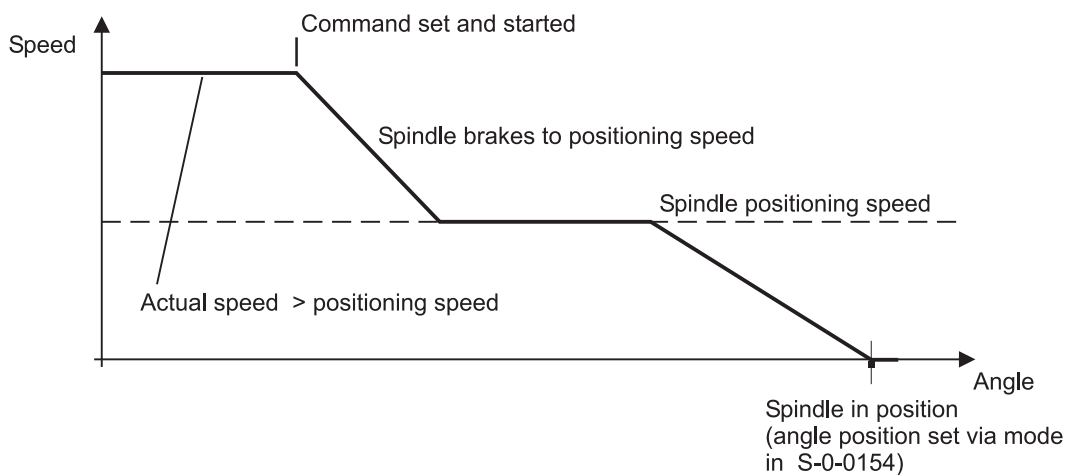

Figure 15: Speed diagram for spindle positioning (1)

4000_0602_rev02_int.cdr

7.7.2 Actual speed ≤ positioning speed

If the actual speed is smaller or equal the positioning speed (▶S-0-0222◀), the drive changes into the internal positioning mode and moves the spindle to the absolute angle, set in ▶S-0-0153◀ with consideration to the settings in the positioning parameter (▶S-0-0154◀).



NOTE

At ▶7.7.1◀ and ▶7.7.2◀ the covered distance is undefined, because the starting position of movement is not defined. Bit 2 of ▶S-0-0154◀ can be 0 only.

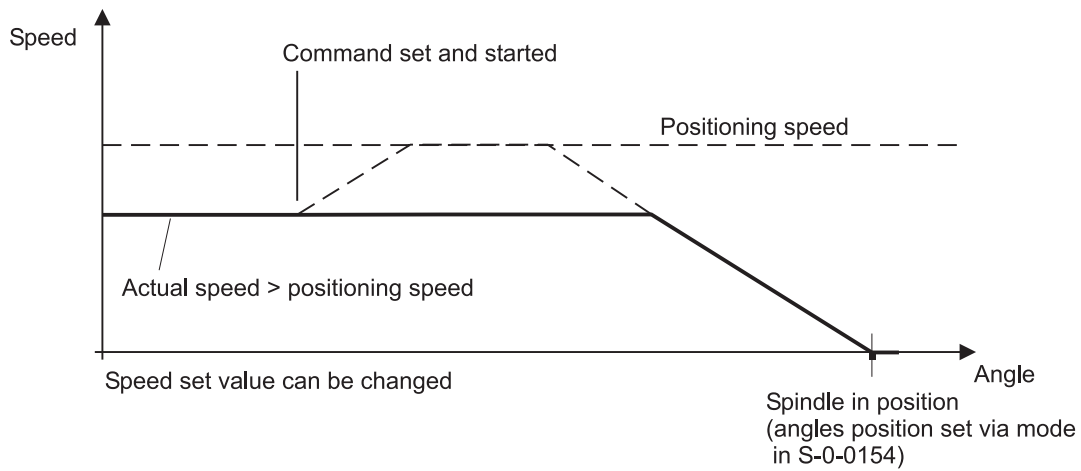

4000_0603_rev02_int.cdr

Figure 16: Speed diagram for spindle positioning (2)

7.7.3 Actual speed = 0

If the command spindle positioning is activated, when the drive is at standstill, then the drive positions the spindle to the spindle angle position ([▶S-0-0153◀](#)) with consideration to the positioning parameter ([▶S-0-0154◀](#)), of the acceleration parameters and of the maximum positioning speed ([▶S-0-0222◀](#)) or the drive positions to a relative spindle distance ([▶S-0-0180◀](#)) also with consideration to the positioning parameter.

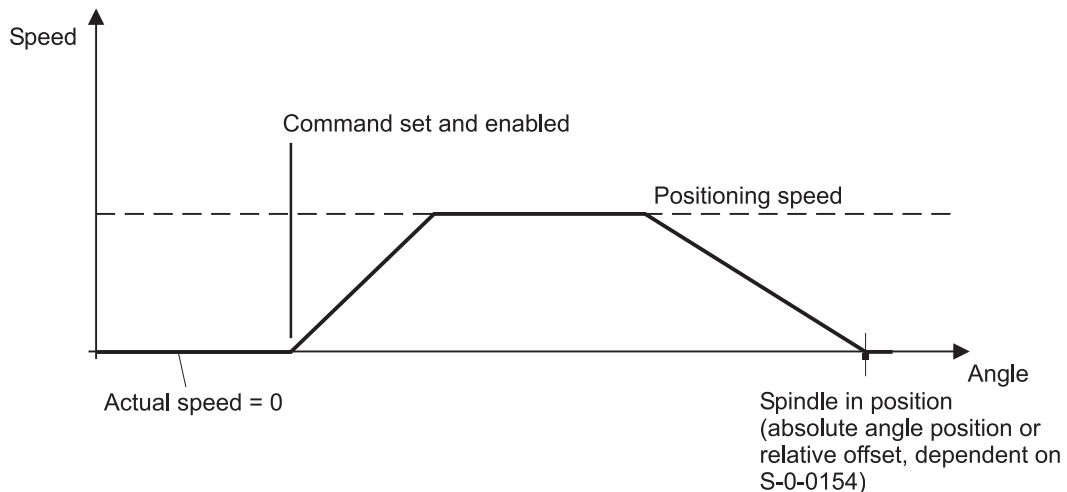

Figure 17: Speed diagram for spindle positioning (3)

7.7.4 New positioning values during the command is active

Whereas the command „Spindle positioning“ ([▶S-0-0152◀](#)) was activated by the control, the drive remains in the positioning operation mode internally and approaches each new (absolute) spindle angle position ([▶S-0-0153◀](#)) or moves to each new (relative) spindle distance ([▶S-0-0180◀](#)), as long as no change between the modes absolute angle and relative offset is set, by writing of the positioning parameter ([▶S-0-0154◀](#)).

The values for relative offset positioning are summed up when writing a new value to [▶S-0-0180◀](#).

A new target position is accepted, by deleting the „in position“ in the C3D bit 6 [▶S-0-0336◀](#)).

7.7.5 Change of the spindle positioning mode, during an active command

The switchover between the absolute spindle angle position ([▶S-0-0153◀](#)) and the setting of a relative spindle travel ([▶S-0-0180◀](#)) during the command spindle positioning ([▶S-0-0152◀](#)) being active, starts with the writing of the positioning parameter ([▶S-0-0154◀](#)) and is not valid until a new target position was written. The original „in position“ status is valid until a new target position has been written.

8

PARAMETERS

In this chapter we describe the parameters which are available, sorted by numbers.



WARNING!

Danger from modification of the parameter settings!

The danger is: **mechanical and electrical danger**

- The change of parameters affects the behavior of the Baumüller-unit and consequently the behavior of the construction and its components. If you change the adjustments of the parameters, you may cause a dangerous behavior of the construction and/or of its components.
- After each modification of the parameter settings, a commissioning with consideration to all safety instructions and safety regulations must be executed.

All S-parameters which are assigned to a b maXX parameters contain the corresponding b maXX parameter values, that means they do not have any own default values. The values of these S parameters are equal to the set b maXX parameter values.

S-parameters, which do not correspond with a b maXX parameter contain default values. However these kind of parameters only existing on the fieldbus controller and generally are implemented for building-up the Sercos communication or are auxiliary factors for conversions and scaling.



NOTE

Parameters, which are perhaps signalled by the drive, but are not specified, are not supported. The use of this parameter can lead to undefined behaviour of the drive.

8.1 Structure of the parameters

Every parameter has

- a name,
- an unique number,
- a data type,
- and fixed attributes or characteristics.

8.1.1 Structure of the parameter description

All parameter descriptions are based on the following scheme:

S-0-0036	Speed set value	-2^{31} to $2^{31}-1$
	CW	4 bytes
	G	0

Description of the function of the parameter.

The different branches of the scheme are described below:

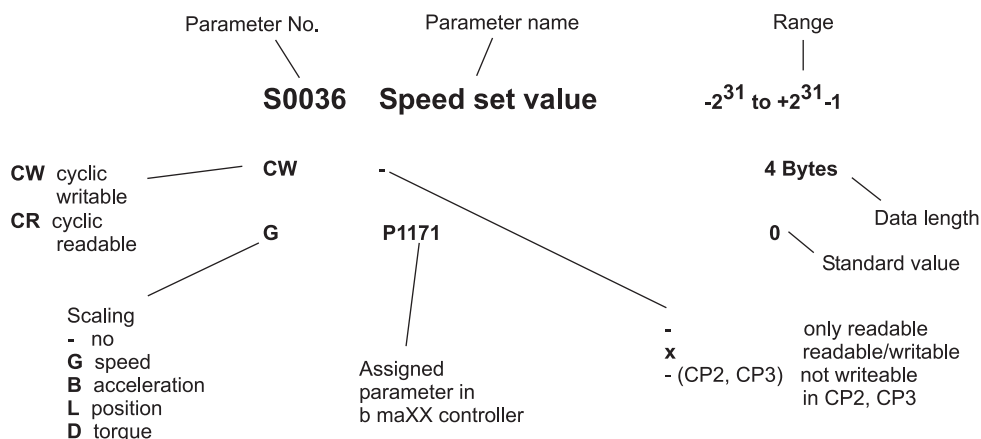

Figure 18: Parameter description scheme



NOTE

The parameter No. in the b maXX controller is a 32 bit value. It contains the No. of the function block, the parameter No., the data set No. and the instance. The mapping of this value as Sercos IDN is not possible because the Sercos IDN allows only 12 bits for parameter No. . Therefore for access to controller parameters via SoE own P parameter numbers are available.

A table in [B.1 List of P parameters](#) from page 159 shows the controller parameters than can be addressed via P parameter numbers.

Controller parameters of data type RECORD (added data types e.g. struct or array) cannot be addressed via SoE.

8.2 Standard parameters

S-0-0001	Control unit cycle time (T_{Ncyc})	250 to 65000 μ s
-	- (CP3, CP4)	2 bytes
1:1	-	1000 μ s
<p>The control unit cycle time defines the cyclic intervals during the control unit generates new set values. The control unit cycle time must be transferred from the master to the slave during CP2 and must be activated from CP3. The fieldbus controller sets the value in the corresponding controller parameters when changing to CP3. A P parameter allocation is not available! The control unit cycle time must an integer multiple of the ▶S-0-0002◀ communication cycle time T_{Scyc}.</p> <p>FW01.09 and higher</p> <p>The assignment of ▶S-0-0001◀ to the controller parameters can be canceled via P-0-1016 Configuration profile 1, bit 7 = 1 while changing state from PreOp to SafeOp. In this case ▶S-0-0001◀ has no influence to the controller and the settings of parameter P-0-0550 Virtual master set value cycle and P-0-0511 Modus (concerns bits 12 - 13 only for setting the factor of the interpolation interval) remain.</p>		
S-0-0002	Communication cycle time (T_{Scyc})	250 to 8000 μ s
-	- (CP3, CP4)	2 bytes
1:1	P-0-1013	1000 μ s
<p>The cycle time of the interface defines the intervals during which the cyclic data are transmitted. The cycle time is transmitted from the master to the slave in CP2 and activated in CP3 for master and slave.</p>		
S-0-0006	AT transmission starting time (T_1)	T_{1min} to T_{Scyc}
-	- (CP3, CP4)	2 bytes
1:1	-	80 μ s
<p>SoE:</p> <p>T_1 specifies a time as offset to the EtherCAT synchronization signal, after that the drive must provide new actual values.</p> <p>This functions is not available at the moment.</p>		
S-0-0007	Feedback acquisition capture point (T_4)	0 to T_{Scyc}
-	- (CP3, CP4)	2 bytes
1:1	-	50 μ s
<p>This functions is not supported using SoE.</p>		
S-0-0008	Command value valid time (T_3)	0 to T_{Scyc}
-	- (CP3, CP4)	2 bytes
1:1	-	510 μ s
<p>This functions is not supported using SoE.</p>		

S-0-0012

Class 2 diagnostic (C2D)

- to -
2 bytes
0

CR
-

Shutdown warning, bit for class 2 (bit 12) is set in [▶S-0-0135◀](#) SERCOS status word.

If the class 2 diagnostic is read via the service channel the change bit of class 2 diagnostic in the SERCOS status word is reset again.

Remaining error codes		Allocated error codes of b maXX parameters													
15	14	13	12	11	10	9	8	7	6	5	4	3	2	1	0
		F0908 Negative software limit switch traversed F0909 Positive software limit switch traversed				W1043 Warning undervoltage U _{DC} link						W1049 Heat sink temp. warning threshold exceeded W1050 Air inside temp. warning threshold exceeded	W0710 Motor temperature warning threshold 1 exceeded W0711 Motor temperature warning threshold 2 exceeded	W0206 I ² t monitoring of power unit activated, , torque current is limited	Reserved

																x Reserved
																x Overtemperature warning (▶S-0-0311◀)
																x Motor overtemperature warning (▶S-0-0312◀)
																x Cooling error warning (▶S-0-0313◀)
																x Reserved
																x Reserved
																x Reserved
																x Reserved
																x Reserved
																x Under voltage warning (DC link voltage)
																x Reserved
																x Reserved
																x Reserved
																x Target position out of traversing range
																x Reserved
																x Manufacturer-specific warning

Bit = 0 no warning
Bit = 1 warning is available

See error parameter [▶Error Handling◀](#) from page 149.



NOTE

The b maXX controller sorts beside of „real“ warnings so-called „Errors without reaction“ to CD2. „Errors without reaction“ require an error acknowledge via [▶S-0-0099◀](#), „real“ warnings do not require.

Furthermore the error reaction of numerous error codes can be parametrized via Pro-Drive. Thus an „Error without reaction“ (C2D) can change to an error of C1D or vice versa.

S-0-0013

CR

-

Class 3 diagnostic (C3D)

-

-

- to -

2 bytes

0

Messages of operation statuses. If a status in the drive changes then the corresponding bit in the class 3 diagnostic changes and the changing bit for class 3 diagnostic (bit 11) in the Sercos status word is set to 1.

If the class 3 diagnostic is read via the service channel the change bit of class 3 diagnostic in the Sercos status word is reset again.

See error parameter [▶Error Handling◀](#) from page 149.

15	14	13	12	11	10	9	8	7	6	5	4	3	2	1	0	Allocated b maXX parameters
			P-0-0686 Status bit 7	P-0-0686 Status bit 5			P-0-0686 Status bit 10		P-0-0686 Status bit 6	P-0-0050 Speed controller status bit 5	P-0-0050 Speed controller status bit 13	P-0-1123 Status current limit bit 10	P-0-0050 Speed controller status bit 9	P-0-0050 Speed controller status bit 6	P-0-0050 Speed controller status bit 12	
																x $n_{\text{actual}} = n_{\text{set}}$ (▶S-0-0330◀)
																x $n_{\text{actual}} = 0$ (▶S-0-0331◀)
																x $ n_{\text{actual}} < n_x $ (▶S-0-0332◀)
																x $ M_{\text{actual}} \geq M_x $ (▶S-0-0333◀)
																x $ M_{\text{actual}} \geq M_{\text{limit}} $ (▶S-0-0334◀)
																x $ n_{\text{set}} > n_{\text{limit}} $ (▶S-0-0335◀)

				P-0-0686 Status bit 7							P-0-0686 Status bit 10				P-0-0686 Status bit 6	P-0-0050 Speed controller status bit 5	P-0-0050 Speed controller status bit 13	P-0-1123 Status current limit bit 10	P-0-0050 Speed controller status bit 9	P-0-0050 Speed controller status bit 6	P-0-0050 Speed controller status bit 12	
15	14	13	12	11	10	9	8	7	6	5	4	3	2	1	0							

Allocated b maXX parameters

										x	In position (►S-0-0336◄)											
										x	Reserved											
										x	Actual position = active target position (►S-0-0338◄)											
					x	x	Reserved															
				x	In position coarse (►S-0-0341◄)																	
			x	Target position reached (►S-0-0342◄)																		
		x	Reserved																			
	x	Status position actual values (see ►S-0-0403◄ , bit 0)																				
x	Reserved																					

Bit = 0 no message
 Bit = 1 message existent

S-0-0014

Interface status

- to -
2 bytes
0

If a communication error is generated, the bit 12 in parameter class 1 diagnostic ([▶S-0-0011◀](#)) is set. The drive resets the communication error only then if there is no interface error anymore and the command „Reset class 1 diagnostic“ ([▶S-0-0099◀](#)) has been received from the drive via the service channel.

The setting of the bits 2 - 0 means no error. If there is no communication error, the interface status contains the current communication phase. If there is a communication error the error and the communication phase are saved.

The meaning of this parameter bits is partly changed comparing SoE and Sercos, but the AL status code of EtherCAT is not entered as recommended in IEC 61800-7-304!

No AL status code is additionally messaged via the [▶S-0-0014◀](#) with exception of the both communication errors „Synchronization lost“ and „Timeout watchdog process data“. This error type is only generated by the slave or acknowledged by the master via the registers of the EtherCAT state machine (AL control, AL status, AL status code).

Additionally in error case the appropriate diagnosis text is entered in [▶S-0-0095◀](#) and the manufacturer specific error code with phase No. is entered in [▶S-0-0375◀](#).

15	14	13	12	11	10	9	8	7	6	5	4	3	2	1	0	
Reserved																
													x	x	x	Communication phase according Sercos 0 = Sercos CP0 1 = Sercos CP1 = EtherCAT Init 2 = Sercos CP2 = EtherCAT Pre-operational 3 = Sercos CP3 = EtherCAT Safe-operational 4 = Sercos CP4 = EtherCAT Operational
												x				EtherCAT: Synchronization lost; AL Status Code 0x002C
											x					EtherCAT: Timeout watchdog process data; AL status code 0x001B
											x					Invalid communication phase
											x					Reserved
											x					Error during phase downshift
											x					Phase switching without ready acknowledge
																x Change to not initialized operation mode, this error bit is dependent on the axis, i. e. it is set only in ▶S-0-0014◀ of the related axis when using a double axis.

Bit = 0 no message

Bit = 1 message existent

Also see [▶Error Handling◀](#) from page 149.

S-0-0015

- Telegram type - to -
 - (CP3, CP4) 2 bytes
 - 3

In the telegram type parameter it can be selected between standard telegrams and application telegrams.

See also [►Telegram◄](#) from page 35 for supported telegrams.

15	14	13	12	11	10	9	8	7	6	5	4	3	2	1	0		
														0	0	0	Standard telegram 0
														0	0	1	Standard telegram 1
														0	1	0	Standard telegram 2
														0	1	1	Standard telegram 3
														1	0	0	Standard telegram 4
														1	0	1	Standard telegram 5
														1	1	0	Standard telegram 6
														1	1	1	Configured telegram
																	(see ►S-0-0016◄ , ►S-0-0024◄)
														0			Position actual value 1 (motor encoder)
														1			Position actual value 2 (external encoder)

S-0-0016

- Configuration list of AT - to -
 - (CP3, CP4) 2 bytes, variable
 - *

* Standard value: 0, 20, 0, 0, 0, 0, 0, 0, 0, 0, 0, 0, 0

In case that in the parameter telegram type ([►S-0-0015◄](#)) the application telegram is determined via this list the configurable data record in the AT is configured user-specific. Only operation data included in „IDN list of configurable data in the AT“ ([►S-0-0187◄](#)) are allowed as cyclic data.

S-0-0017

- IDN list of all operation data - to -
 - 2 bytes, variable
 -

All parameter numbers of the existing operating data in the drive are saved in this IDN list.

S-0-0018	IDN list of operation data for CP2	- to - 2 bytes, variable *
-	-	
-	-	
	* Standard value: 46, 46, S1 , S2 , S6-S10 , S15 , S16 , S24 , S32-S35 , S43 , S55 , S85 , S89 , S91 , S91 , S96 , S99 , S127	
	All parameter numbers which must be transmitted in communication phase 2 are saved in this IDN list. The processing of this IDN list must have been taken place before switching to communication phase 3.	
	SoE: Here the communication parameters without function can be unconsidered.	
S-0-0019	IDN list of operation data for CP3	- to - 2 bytes, variable *
-	-	
-	-	
	* Standard value: 2, 2, S128	
	All parameter numbers which must be transmitted in communication phase 3 are saved in this IDN list. The processing of this IDN list must have been taken place before switching to communication phase 4.	
	SoE: Here the ▶S-0-0128◀ is without function.	
S-0-0020	IDN list of operation data for CP4	- to - 2 bytes, variable *
-	-	
-	-	
	* Standard value: 0, 4	
	All parameter numbers which can be changed in communication phase 4 are saved in this IDN list.	
S-0-0021	IDN list of invalid operation data for CP2	- to - 2 bytes, variable *
-	-	
-	-	
	* Standard value: 0, 20, 0, 0, 0, 0, 0, 0, 0, 0, 0, 0	
	Before the drive executes the phase upshift from phase 2 to 3, which is accordant to the command „Transition check phase 2 to 3“ (▶S-0-0127◀) it checks if all communication parameters are complete and correct.	
	In case the drive recognizes one or several parameter numbers as invalid it writes the still be required or invalid operating data into this IDN list.	
	If the command has been correctly executed the IDN list is empty.	

S-0-0022**IDN list of invalid operation data for CP3**

- to -
2 bytes, variable
*

* Standard value: 0, 20, 0, 0, 0, 0, 0, 0, 0, 0, 0, 0

Before the drive executes the phase upshift from phase 3 to 4, which is accordant to the command „Transition check phase 3 to 4" ([▶S-0-0128◀](#)), the drive checks if all communication parameters are complete and correct.

In case the drive recognizes one or several parameter numbers as invalid it writes the still be required or invalid operating data into this IDN list.

If the command has been correctly executed the IDN list is empty.

S-0-0023**IDN list of invalid operation data for CP4**

- to -
2 bytes, variable
*

* Standard value: 0, 20, 0, 0, 0, 0, 0, 0, 0, 0, 0, 0

The parameter numbers in the operation data which has been recognized in communication phase 4 from the drive as invalid is saved in this IDN list.

S-0-0024**Configuration list of MDT**

- (CP3, CP4)

- to -
2 bytes, variable
*

* Standard value: 0, 20, 0, 0, 0, 0, 0, 0, 0, 0, 0, 0

The configuration list MDT contains the parameter numbers whose operation data will be transmitted cyclically in the MDT in an application telegram. The drive needs to support this list only when it supports the configured telegram in its telegram type parameter ([▶S-0-0015◀](#)).

Only operation data contained in the „IDN list of configurable data in the MDT" ([▶S-0-0188◀](#)) are allowed as cyclic data.

S-0-0025**IDN list of all procedure commands**

- to -
2 bytes, variable
*

* Standard value: 28, 28, **S99, S127, S128, S139, S146, S148, S152, S170, S171, S172, S197, S262, S263, S264**

All parameter numbers of existing drive commands are saved in this IDN list.

SoE:

The commands are not started via [▶S-0-0127◀](#) or [▶S-0-0128◀](#). The phase change is done via the EtherCAT state machine.

S-0-0026	Configuration list signal statusword	- to - 2 bytes, variable *																																																																
-	-(CP3, CP4)																																																																	
-	-																																																																	
	* Standard value: 0, 32																																																																	
	The application list contains all IDNs, which are part of the signal statusword (see ▶S-0-0144◀). The correct order of IDNs in the application list is determined by the bit numbering diagram in the signal statusword. The first IDN of the application list defines bit 0, the last IDN defines bit 15 of the signal statusword. The ▶S-0-0328◀ for selection of the bit No. is supported by the b maXX controller.																																																																	
S-0-0027	Configuration list signal controlword	- to - 2 bytes, variable *																																																																
-	-(CP3, CP4)																																																																	
-	-																																																																	
	* Standard value: 0, 32																																																																	
	The application list contains all IDNs, which are part of the signal controlword (see ▶S-0-0145◀). The correct order of IDNs in the application list is determined by the bit numbering diagram in the signal controlword. The first IDN of the application list defines bit 0, the last IDN defines bit 15 of the signal controlword.																																																																	
	Bit 0 of the IDN is always configured. S-0-0329 is not supported.																																																																	
	NOTE: It is not allowed to configure S parameters with P parameter allocation or P parameters. The drive reacts in this case with service channel error „Date not correct“.																																																																	
S-0-0028	MST error counter	0 to 65535 2 bytes 0																																																																
-	-																																																																	
1:1	-																																																																	
	SoE: This parameter signals missing cyclic telegrams. It contains the value „RX-error counter“ and „Lost-link counter“ of the EtherCAT controller for port A and B. It can be reset only by writing of counter register by the EtherCAT master.																																																																	
	<table border="1" style="margin-left: auto; margin-right: auto; border-collapse: collapse; text-align: center;"> <tr> <td>15</td><td>14</td><td>13</td><td>12</td><td>11</td><td>10</td><td>9</td><td>8</td><td>7</td><td>6</td><td>5</td><td>4</td><td>3</td><td>2</td><td>1</td><td>0</td> </tr> <tr> <td> </td><td> </td><td> </td><td> </td><td> </td><td> </td><td> </td><td> </td><td> </td><td> </td><td> </td><td> </td><td> </td><td> </td><td> </td><td> </td> </tr> <tr> <td> </td><td> </td><td> </td><td> </td><td> </td><td> </td><td> </td><td> </td><td> </td><td colspan="7">∑ Rx errors port A/B</td> </tr> <tr> <td colspan="8">∑ Lost links port A/B</td><td colspan="8"></td> </tr> </table>		15	14	13	12	11	10	9	8	7	6	5	4	3	2	1	0																										∑ Rx errors port A/B							∑ Lost links port A/B															
15	14	13	12	11	10	9	8	7	6	5	4	3	2	1	0																																																			
									∑ Rx errors port A/B																																																									
∑ Lost links port A/B																																																																		
S-0-0029	MDT error counter	0 to 65535 2 bytes 0																																																																
-	-																																																																	
1:1	-																																																																	
	This function is not supported at the moment.																																																																	

- S-0-0030** **Manufacturer version** - to -
 - - 2 bytes
 - - b maXX SoE
- The current version as text can be read from this parameter.
 Example: "b maXX SoE V01.07.02 S (Build18381)".
- S-0-0031** **Hardware version** - to -
 - - 2 bytes
 - - 33.0000A
- The hardware board identification of the b maXX controller is set here while boot-up. Use for diagnostic functions only.
- S-0-0032** **Primary operation mode** - to -
 - - (CP4) 2 bytes
 1:1 - 2
- The operation mode set in this parameter is activated in the drive if the primary operation mode is selected in MDT control word.
- Also see [▶Operation mode parameters◀](#) on page 40.
- S-0-0033** **Secondary operation mode 1** - to -
 - - (CP4) 2 bytes
 1:1 - 2
- The operation mode set in this parameter is activated in the drive if the secondary operation mode 1 is selected in MDT control word.
- Also see [▶Operation mode parameters◀](#) on page 40.
- S-0-0034** **Secondary operation mode 2** - to -
 - - (CP4) 2 bytes
 1:1 - 2
- The operation mode set in this parameter is activated in the drive if the secondary operation mode 2 is selected in MDT control word.
- Also see [▶Operation mode parameters◀](#) on page 40.
- S-0-0035** **Secondary operation mode 3** - to -
 - - (CP4) 2 bytes
 1:1 - 2
- The operation mode set in this parameter is activated in the drive if the secondary operation mode 3 is selected in MDT control word.
- Also see [▶Operation mode parameters◀](#) on page 40.

S-0-0036	Velocity command value	-2^{31} to $+2^{31}-1$
CW, CR	x	4 bytes
G	P-0-0333	0
	<p>In speed control this value together with the „Additive velocity command value“ (▶S-0-0037◀) generates an effective speed set value of the drive.</p> <p>Scaling must be considered (also see scaling ▶Speed data◀ from page 26).</p> <p>NOTE: The current effective speed set value on speed controller input is displayed in P-0-0051.</p>	
S-0-0037	Additive velocity command value	-2^{31} to $+2^{31}-1$
CW, CR	x	4 bytes
G	P-0-0078	0
	<p>In speed control this value is added to the „Velocity command value (▶S-0-0036◀)“.</p> <p>Scaling must be considered (also see scaling ▶Speed data◀ from page 26).</p>	
S-0-0038	Positive velocity limit value	0 to $+2^{31}-1$
-	x	4 bytes
G	P-0-0081	0
	<p>This value describes the maximum permissible speed in positive direction. If the speed limit value was exceeded, the drive responds by setting the status „$n_{set} > n_{limit}$“ in class 3 diagnostic (▶S-0-0013◀), bit 5.</p> <p>Scaling must be considered (also see scaling ▶Speed data◀ from page 26).</p>	
S-0-0039	Negative velocity limit value	-2^{31} to 0
-	x	4 bytes
G	P-0-0082	0
	<p>This value describes the maximum permissible speed in negative direction. If the speed limit value is exceeded, the drive responds by setting the message $n_{set} > n_{limit}$ in class 3 diagnostic (▶S-0-0013◀), bit 5.</p> <p>Scaling must be considered (also see scaling ▶Speed data◀ from page 26).</p>	

S-0-0040	Velocity feedback value 1	-2^{31} to $+2^{31}-1$
CR	-	4 bytes
G	P-0-0052	0
<p>This value is transmitted from the drive to the control in order to allow speed display if necessary.</p> <p>Scaling must be considered (also see scaling ►Speed data◄ from page 26).</p>		
S-0-0041	Homing velocity	-2^{31} to $+2^{31}-1$
CW	x	4 bytes
G	P-0-0644	0
<p>Homing velocity is necessary in the drive, if the command „Drive controlled homing“ is active. The drive independently executes homing.</p> <p>Scaling must be considered (also see scaling ►Speed data◄ from page 26).</p>		
S-0-0042	Homing acceleration	0 to $+2^{31}-1$
CW	x	4 bytes
B	P-0-0646, P-0-0647	0
<p>Homing acceleration is necessary in the drive, if the command „Drive controlled homing“ is active. The drive independently executes homing.</p> <p>Scaling must be considered (also see scaling ►Speed data◄ from page 26).</p>		

S-0-0043

Velocity polarity parameter

- to -
2 bytes
0

- (CP4)
-

In this parameter the polarities of the specified speed data can be accordant to the application switched over. The polarities are not switched over within, but outside of a controlled system (at input and output). At positive speed set value difference and at not-inverted polarity, there is clockwise rotation facing the motor shaft.

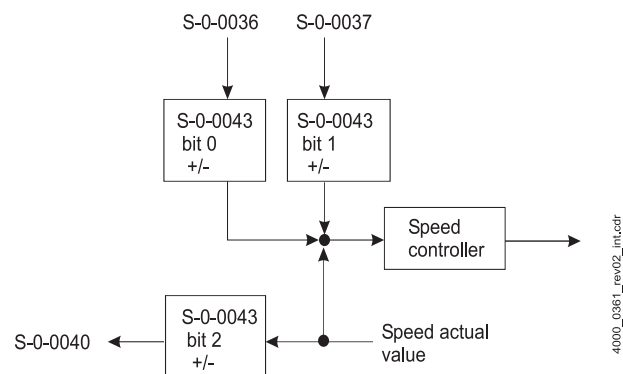
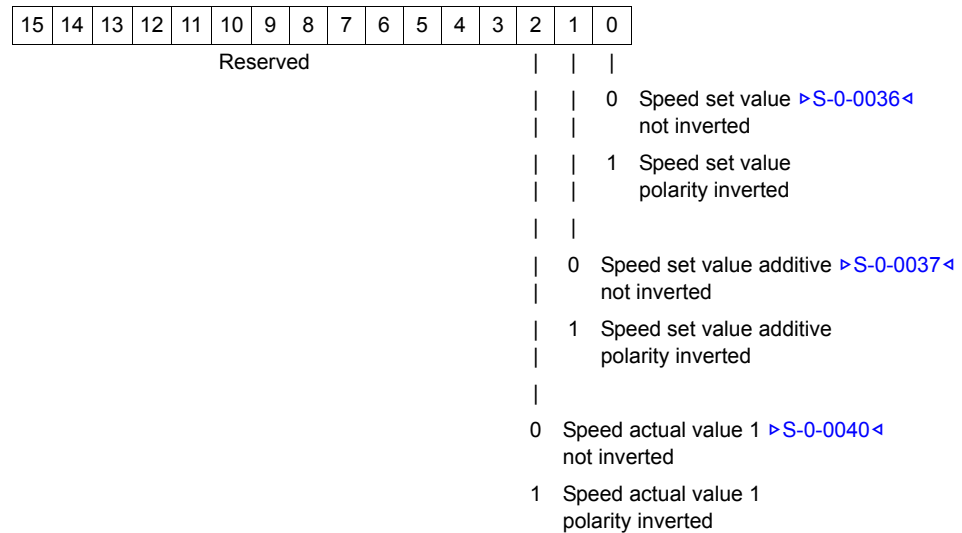

Figure 19: Speed polarities

S-0-0044**Velocity data scaling type**

- to -

- (CP4)

2 bytes

-

0xA

With these parameters the method of scaling for speed data is selected. It is defined, which format master and drive have to use for data exchange.

See scaling [▶Speed data◀](#) from page 26.

15	14	13	12	11	10	9	8	7	6	5	4	3	2	1	0	
Reserved																
													0	0	0	Incremental scaling (without scaling)
													0	0	1	Linear scaling
													0	1	0	Rotatory scaling unit [revolutions]
													0			Preferred scaling
													1			Parameter scaling
													0			Unit linear scaling: Meter
													1			Unit linear scaling: Inch
													0			Time unit minutes
													1			Time unit seconds
																0 Data referring to motor shaft
																1 Data referring to load

S-0-0045**Velocity data scaling factor**1 to $+2^{16}-1$

- (CP4)

2 bytes

-

1

With this parameter the scaling factor for speed data is determined.

In case of preferred scaling the parameter is set to 1.

Also see scaling [▶Speed data◀](#) from page 26.

S-0-0046	Velocity data scaling exponent	-9 to 3
-	-(CP4)	2 bytes
-	-	-4

With this parameter the scaling exponent for speed data is determined.

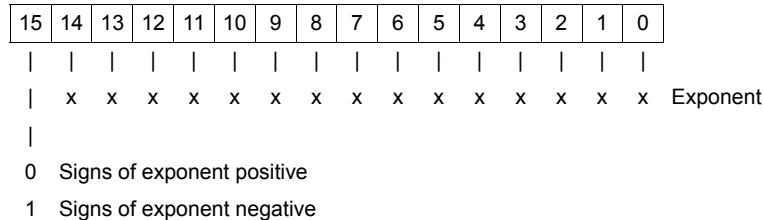

Also see scaling [▶Speed data◀](#) from page 26.

S-0-0047	Position command value	-2^{31} to $+2^{31}-1$
CW, CR	x	4 bytes
L	P-0-0514	0

This is the set value for the drive in position control.

Scaling must be considered
(also see scaling [▶Position data◀](#) from page 23).

S-0-0048	Additive position command value	-2^{31} to $+2^{31}-1$
CW	x	4 bytes
L	-	0

This parameter is used if an additional position offset at position control in the drive is necessary. The additive position command value is added to the position command value ([▶S-0-0047◀](#)).

Scaling must be considered
(also see scaling [▶Position data◀](#) from page 23).

S-0-0049	Position limit positive	-2^{31} to $+2^{31}-1$
-	x	4 bytes
L	P-0-0673	0

The positive position limit specifies the maximum admitted distance in the positive direction. The positive position limit value is only active, if all position data of the machine are based on a zero point. If the positive position limit value is exceeded, the drive sets the error bit in C1D ([▶S-0-0011◀](#)), bit 13.

Scaling must be considered
(also see scaling [▶Position data◀](#) from page 23).

The activation of this monitoring is set via P-0-0670 Positioning general mode, bit 0 (bit 0 = 1 ⇔ monitoring switched on).

S-0-0050 - L	Position limit negative X P-0-0672	-2 ³¹ to +2 ³¹ -1 4 bytes 0
<p>The negative position limit specifies the maximum admitted distance in the negative direction. The negative position limit value is only active, if all position data of the machine are based on a zero point. If the negative position limit value is exceeded, the drive sets the error bit in C1D (▶S-0-0011◀), bit 13.</p> <p>Scaling must be considered (also see scaling ▶Position data◀ from page 23).</p>		
S-0-0051 CR L	Position feedback value 1 (motor feedback) - P-0-0978, P-0-0979	-2 ³¹ to +2 ³¹ -1 4 bytes 0
<p>This parameter provides the position actual value.</p> <p>Scaling must be considered (also see scaling ▶Position data◀ from page 23).</p>		
S-0-0052 - L	Reference distance 1 X P-0-0642	-2 ³¹ to +2 ³¹ -1 4 bytes 0
<p>This parameter describes the distance between the machine zero point and the reference point related to the motor measuring system. After homing the position actual value 1 is calculated from the</p> <ul style="list-style-type: none"> • Reference distance 1 (▶S-0-0052◀) • Marker position A (▶S-0-0173◀) <p>Scaling must be considered (also see scaling ▶Position data◀ from page 23).</p>		
S-0-0053 CR L	Position feedback value 2 (external encoder) - -	-2 ³¹ to +2 ³¹ -1 4 bytes 0
<p>This parameter provides the position actual value of the optional encoder.</p> <p>Scaling must be considered (also see scaling ▶Position data◀ from page 23).</p> <p>NOTE This parameter is available only with devices providing 2 encoder inputs per axis. This parameter cannot be accessed to by using a P parameter No. .</p>		

S-0-0054

-
L

Reference distance 2
X
P-0-0642

-2^{31} to $+2^{31}-1$
4 bytes
0

This parameter describes the distance between the machine zero point and the reference point related to the external encoder.

After homing the position actual value 2 is calculated from the

- Reference distance 2 ([▶S-0-0054◀](#))
- Marker position A ([▶S-0-0173◀](#))

Scaling must be considered

(also see scaling [▶Position data◀](#) from page 23).

S-0-0055

-
-

Position polarity parameter
- (CP4)
-

- to -
2 bytes
0

With this parameter the polarities of the specified position data can be inverted.

15	14	13	12	11	10	9	8	7	6	5	4	3	2	1	0			
Reserved																		
															0	Position set value ▶S-0-0047◀ not-inverted		
															1	Position set value polarity inverted		
															0	Position set value additive ▶S-0-0048◀ not-inverted		
															1	Position set value additive polarity inverted		
															0	Position actual value 1 ▶S-0-0051◀ not-inverted		
															1	Position actual value 1 polarity inverted		
															0	Position actual value 2 ▶S-0-0053◀ not-inverted		
															1	Position actual value 2 polarity inverted		

NOTE:

The monitoring of the position limit values must be switched on and switched off via P-0-0670 bit 3. Bit 4 of [▶S-0-0055◀](#) is not supported

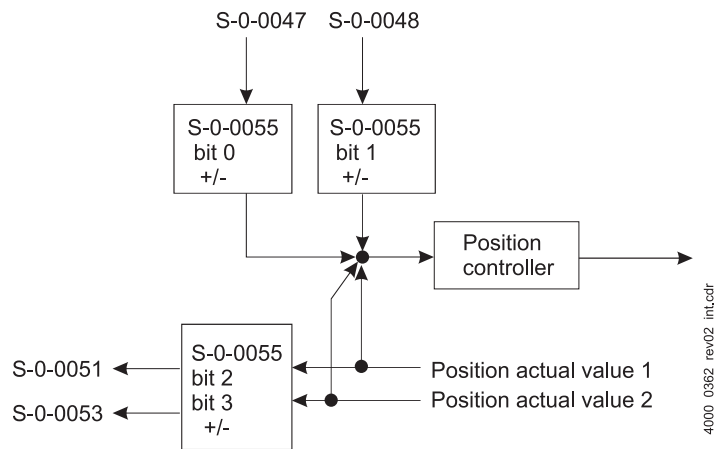

Figure 20: Position polarities

S-0-0057-
L**Position window**X
P-0-06740 to $+2^{31}-1$
4 bytes
0

When the difference between the position set value and the position actual value (position deviation) is lower than the position window, then the drive sets the status „In position“ ([▶S-0-0336◀](#)). In case of requirement the status „In position“ is allocated to a realtime status bit ([▶S-0-0305◀](#)) and is transmitted in the drive status for further processing to the control.

Scaling must be considered
(also see scaling [▶Position data◀](#) from page 23).

S-0-0058-
L**Clearance**X
-0 to $+2^{31}-1$
4 bytes
0

The clearance describes the amount of backlash between motor and load during reversal, relative to the position data.

This parameter is without function at the moment!

S-0-0076

-
-

Position data scaling type

- (CP4)
-

- to -
2 bytes
0xA

With this parameter the scaling type for position data is selected. It is defined, which format master and drive have to use for data exchange.

See scaling [Position data](#) from page 23.

15	14	13	12	11	10	9	8	7	6	5	4	3	2	1	0
Reserved															
													0	0	0
													0	0	1
													0	1	0
												0	Preferred scaling		
												1	Parameter scaling		
											0	Unit at linear scaling: Meter			
											1	Unit at linear scaling: Inch			
										x	Reserved				
									0	Data referring to motor shaft					
									1	Data referring to load					
								0	Absolute format						
								1	Modulo format						

S-0-0077

-
-

Linear position data scaling factor

- (CP4)
-

1 to 65535
2 bytes
1

In this parameter the scaling factor for all position data in this drive is determined.

See scaling [Position data](#) from page 23.

S-0-0078	Linear position data scaling exponent	-9 to +3
-	-(CP4)	2 bytes
-	-	-7

In this parameter the scaling exponent for all position data in this drive is determined.

See scaling [►Position data◄](#) from page 23.

15	14	13	12	11	10	9	8	7	6	5	4	3	2	1	0
	x	x	x	x	x	x	x	x	x	x	x	x	x	x	x
	Exponent														
0	Signs of exponent positive														
1	Signs of exponent negative														

S-0-0079	Rotational position resolution	0 to +2 ³¹ -1
-	-(CP4)	4 bytes
-	P-0-0684	36*10 ⁵

This parameter contains the value of rotational position resolution and determines the LSB value of the rotational scaling. If preferred scaling has been selected the value is 3600000. This means a LSB value of 0.0001 degrees.

S-0-0080	Torque command value	-2 ¹⁵ to +2 ¹⁵ -1
CW, CR	x	2 bytes
D	P-0-0068	0

In operation mode torque control this torque set value together with the torque set value additive ([►S-0-0081◄](#)) generates the effective torque set value of the drive.

Scaling must be considered
(also see scaling [►Torque and force data◄](#) from page 30).

S-0-0081	Additive torque command value	-2 ¹⁵ to +2 ¹⁵ -1
CW, CR	x	2 bytes
D	P-0-0109	0

In torque control this set value is added to torque command value ([►S-0-0080◄](#)).

Scaling must be considered
(also see scaling [►Torque and force data◄](#) from page 30).

S-0-0082

CW
D

Positive torque limit value

x
P-0-1101

0 to $+2^{15}-1$
2 bytes
4096

The positive torque limit value describes the maximum permissible torque in positive direction. If the torque limit value is exceeded the drive generates the status „ $M_{d \text{ actual}} > M_{d \text{ limit}}$ “ into class 3 diagnostic ([▶S-0-0013◀](#)), bit 4.

Scaling must be considered
(also see scaling [▶Torque and force data◀](#) from page 30).

S-0-0083

CW
D

Negative torque limit value

x
P-0-1102

0 to $+2^{15}-1$
2 bytes
4096

The negative torque limit value describes the maximum permissible torque in negative direction. If the torque limit value is exceeded the drive generates the status „ $M_{d \text{ actual}} > M_{d \text{ limit}}$ “ into class 3 diagnostic ([▶S-0-0013◀](#)), bit 4.

Scaling must be considered
(also see scaling [▶Torque and force data◀](#) from page 30).

S-0-0084

CR
D

Torque feedback value

-
P-0-1119

- to -
2 bytes
0

The torque feedback value is transmitted from the drive to the control in order to allow a torque display in the control if necessary.

Scaling must be considered
(also see scaling [▶Torque and force data◀](#) from page 30).

S-0-0085

Torque polarity parameter

- to -
2 bytes
0

With this parameter the polarities of the specified torque data can be inverted.

15	14	13	12	11	10	9	8	7	6	5	4	3	2	1	0
Reserved															
															0 Torque set value ▶S-0-0080◀ not inverted
															1 Torque set value polarity inverted
															0 Torque set value additive ▶S-0-0081◀ not inverted
															1 Torque set value additive polarity inverted
															0 Torque actual value ▶S-0-0084◀ not inverted
															1 Torque actual value polarity inverted

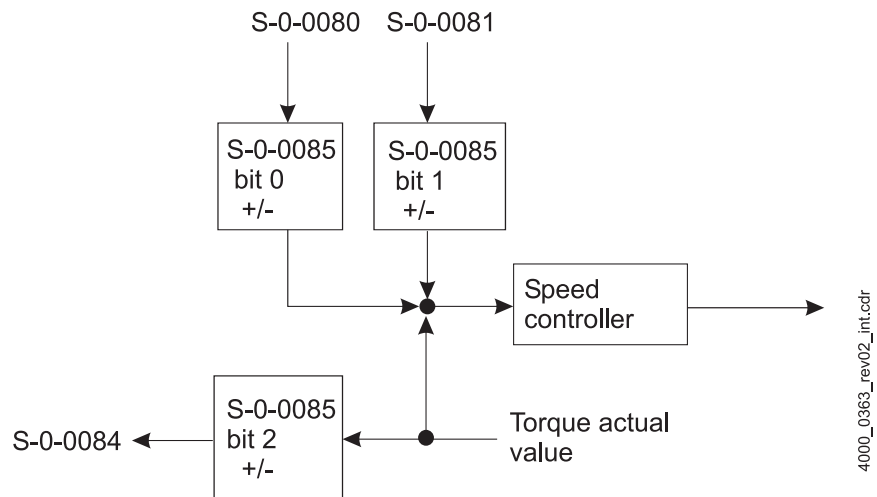

Figure 21: Torque polarities

S-0-0086

-
-

Torque/force data scaling factor

- (CP4)
-

- to -
2 bytes
0xA

By means of the scaling type the different scaling methods can be set, also see [► Torque and force data](#) from page 30.

15	14	13	12	11	10	9	8	7	6	5	4	3	2	1	0		
Reserved																Scaling type	
														0	0	0	Percentage scaling
														0	0	1	Linear scaling (force)
														0	1	0	Rotatory scaling (torque)
													0	Preferred scaling			
													1	Parameter scaling			
												0	Unit at force (Newton N)				
												0	Unit at torque (Newton meter Nm)				
												1	Unit at force: lpf				
												1	Unit at torque: in lpf				
											x	Reserved					
										0	Data reference at the motor shaft						
										1	Data reference at the load						

S-0-0087

-
-

Transmit to transmit recovery time (T_{ATAT})

-
-

- to -
2 bytes
0

SoE:

Without function.

S-0-0089

-
1:1

MDT transmission starting time (T_2)

- (CP3, CP4)
-

0 to T_{scyc}
2 bytes
0

SoE:

T_2 specifies a point of time as offset to the EtherCAT synchronization signal, at which new set values shall be taken over by the drive.

This function is not implemented at the moment!

S-0-0091CW
G**Bipolar velocity limit value**x
P-0-0081, P-0-00820 to $2^{31}-1$
4 bytes
0

This parameter describes the maximum allowable speed in both directions. If the speed limit value is exceeded, the drive responds by setting the status $n_{\text{set}} > n_{\text{limit}}$ in class 3 diagnostic ([▶S-0-0013◀](#)), bit 5.

Scaling must be considered
(also see scaling [▶Speed data◀](#) from page 26).

S-0-0092CW
D**Bipolar torque limit value**x
P-0-11130 to $2^{15}-1$
2 bytes
0

This parameter limits the maximum torque in both directions.

If the torque limit value is exceeded, the drive sets the status $M_{\text{d actual}} \geq M_{\text{d limit}}$ in class 3 diagnostic ([▶S-0-0013◀](#)), bit 4.

Scaling must be considered
(also see scaling [▶Torque and force data◀](#) from page 30).

S-0-0093-
-**Torque/force data scaling factor**- (CP4)
-1 to $+2^{16}-1$
2 bytes
1

In this parameter the scaling factor for all torque/force data in this drive is determined.

Also see scaling [▶Torque and force data◀](#) from page 30.

S-0-0094-
-**Torque/force data scaling exponent**- (CP4)
--9 to +3
2 bytes
-2

In this parameter the scaling exponent for all torque/force data in this drive is determined.

15	14	13	12	11	10	9	8	7	6	5	4	3	2	1	0
	x	x	x	x	x	x	x	x	x	x	x	x	x	x	x
	0 Signs of exponent positive														
	1 Signs of exponent negative														

Also see scaling [▶Torque and force data◀](#) from page 30.

S-0-0095

Diagnostic message

- to -
1 Byte, variable
0

This parameter shows the current operation status of the drive as text message

When displaying an error or warning the text consists of the error code (decimal) and an error description. This error code corresponds with the value (here hexadecimal) of [▶S-0-0390◀](#).

The diagnostic message can be switched off at a phase change via P-0-1016 Configuration profile 1, bit 0 ⇒ Bit 0 = 1.

A reset via [▶S-0-0099◀](#) „deletes“ the display ⇒ „no error“ or „no warning“

Examples:

E0400: Error drive| Amplitude of encoder signal too low

W1522: Warning fieldbus| Error at writing service data

Communication phase 4 ready

Error: Command IDN-0139 cannot be executed

S-0-0096

Slave arrangement (SLKN)

- to -
2 bytes
0

SoE:

This parameter is without function.

S-0-0097

Mask class 2 diagnostic

- to -
2 bytes
0xFFFF

Using this mask, warnings in class 2 diagnostic can be masked with respect to their effect on the change bit in drive status. When changing masked warnings the change bit in the drive status is not set. The mask does not effect the operation data of class 2 diagnostic ([▶S-0-0012◀](#)).

15	14	13	12	11	10	9	8	7	6	5	4	3	2	1	0
x	x	x	x	x	x	x	x	x	x	x	x	x	x	x	x

0 Warning masked

1 Warning not masked

S-0-0098**Mask class 3 diagnostic**

- to -
2 bytes
0xFFFF

- X
-

Using this mask, condition flags in class 3 diagnostic can be masked with respect to their effect on the change bit in drive status. When changing masked warnings the change bit in the drive status is not set. The mask does not effect the operation data of class 3 diagnostic ([▶S-0-0013◀](#)).

15	14	13	12	11	10	9	8	7	6	5	4	3	2	1	0
x	x	x	x	x	x	x	x	x	x	x	x	x	x	x	x

0 Warning masked
1 Warning not masked

S-0-0099**Reset class 1 diagnostic**

- to -
2 bytes
0

- X
-

If this command has been received from the drive and there are no errors existent anymore all error bits of class 1 diagnostic ([▶S-0-0011◀](#)), manufacturer class 1 diagnostic ([▶S-0-0129◀](#)) and interface status ([▶S-0-0014◀](#)) are reset.

In addition the display of parameter [▶S-0-0095◀](#) Diagnostic message and [▶S-0-0390◀](#) Diagnostic number is reset.

Also see [▶Error reset◀](#) on page 154.

S-0-0100**Velocity loop proportional gain**

0 to 1 000 000.00
4 bytes
10.00

- X
100:1 P-0-0054

Defines the P-gain of the speed controller, resolution 0.01 1/s.

Example:

32500 (Sercos) ⇒ 325.00 1/s (P-0-0054 b maXX controller)

S-0-0101**Velocity loop integral action time**

0 to 6553.5
2 bytes
10.00

- X
10:1 P-0-0055

Defines the integral action time of the speed controller, resolution 0.1 ms.

Example scaling:

105 (Sercos) ⇒ 0.0105 s (P-0-0055 b maXX controller)

S-0-0102	Velocity loop differential time	0.0 to 100.0
-	x	2 bytes
10:1	P-0-0056	0
<p>Defines the differential time of the speed controller, resolution 0.1 ms.</p> <p>Example scaling: 11 (Sercos) ⇒ 0.001100 s (P-0-0056 b maXX controller)</p>		
S-0-0103	Modulo value	1 to +2 ³¹ -1
-	- (CP4)	4 bytes
L	P-0-0683	36*10 ⁵
<p>If it has been ▶S-0-0076◀ selected in the modulo format, this parameter determines, if the position data are 0. The parameter defines multiples of whole rotations.</p> <p>Scaling must be considered (also see scaling ▶Position data◀ from page 23).</p>		
S-0-0104	Position loop Kv-factor	0 to 655.35
-	x	2 bytes
100:1	P-0-0046	1.20
<p>Defines the gain of the position controller, resolution 0.01 (m/min)/mm.</p> <p>Example scaling: 684 (Sercos) ⇒ 114.00 1/s (P-0-0046 b maXX controller); conversion factor 1/6</p>		
S-0-0106	Current loop proportional gain 1	1 to 10000.00
-	x	4 bytes
100:1	P-0-0136	10.00
<p>Defines the proportional gain of the Iq current controller (torque-building current), resolution 0.01 V/A.</p> <p>Example scaling: 4500 (Sercos) ⇒ 45.00 V/A (P-0-0136 b maXX controller)</p>		
S-0-0107	Current loop integral action time 1	0 to 65535
-	x	2 bytes
1:1	P-0-0137	5000
<p>Defines the integral action time of the Iq current controller in μs.</p> <p>Example scaling: 8183 (Sercos) ⇒ 8.183 ms (P-0-0137 b maXX controller)</p>		

S-0-0108CW, CR
100:1**Feedrate override**- 0 to 655.35
P-0-0676 2 bytes
100.00

The „Feedrate override“ is activated only with drive controlled procedure commands. In such a case the speed set values are calculated by the drive internally. The „Feedrate override“ has multiplying effects on the speed set values.

The „Feedrate override“ is active in the following operation modes:

- Drive internal interpolation
- Position target setting
- Manual mode, position controlled (see [>Operation mode parameters<](#) from page 40)

S-0-0109-
1000:1**Motor peak current**- (CP4) 0 to 6553.500
P-0-0851 4 bytes
0

This is an informative parameter in the b maXX controller, i.e. there is no limitation of the amplifier current.

Example scaling:

1500 (Sercos) \Rightarrow 1.500 (P-0-0851 b maXX controller)

S-0-0110-
1000:1**Amplifier peak current**- 0 to 1000.000
P-0-0025 4 bytes
9.000

The parameter displays the maximum permitted current of the amplifier. The value depends on the set frequency of the PWM frequency (P-0-0937).

Example scaling:

9000 (Sercos) \Rightarrow 9.000 A (P-0-0025 b maXX controller)

S-0-0112-
1000:1**Amplifier rated current**- 0 to 1000.00
P-0-0026 4 bytes
4.500

The rated current of the amplifier is equal to the allowable continuous current of the drive unit. The value depends on the set frequency of the PWM frequency (P-0-0937).

Example scaling:

1500 (Sercos) \Rightarrow 1.500 A (P-0-0026 b maXX controller)

S-0-0113	Maximum motor speed	1 to 24000.000
-	- (CP4)	4 bytes
1*10 ⁴ :1	P-0-0342	3000.000

The parameter contains the maximum speed of the motor. The value is used for speed scaling of the b maXX controller within the function ramp function generator (P-0-0333 bzw. P-0-0334). The fieldbus controller uses the parameter to adapt the Sercos speed scaling to the scaling of the b maxx controller.

The maximum speed of the motor according the data sheet contains P-0-0856. This parameter is set automatically by ProDrive when selecting the motor at commissioning or is set manually according motor data sheet.

Is [▶S-0-0113◀](#) set higher than the maximum motor speed according motor data sheet (display in P-0-0856 Maximum speed mechanically), the error 212 is generated in speed-controlled operation modes when enabling the drive.

The resulting set speed is limited on base of P-0-0856 and the gear ratio P-0-0048 at position-controlled operation modes. An error message 910 is generated in addition in operation modes position control and synchronization mode only.

Further details see parameter manual b maXX 5000 or 3300.

IMPORTANT:

The [▶S-0-0113◀](#) must be set in that way the mechanical maximum motor speed cannot be exceeded in speed set value. If the user ignores the error messages 212 or 910, the set speed can be higher than the mechanical maximum speed, leading to motor damage and mechanical damage!

The parametrization is not checked, if P-0-0856 consists the value 0 U/min!

Example scaling:

300 0000 (Sercos) ⇒ 3000.000 (P-0-0342 b maXX controller)

S-0-0114	Load limit of motor	0 to 1000
-	-	2 bytes
1:1	P-0-0029	100

The parameter is a percentage value of Motor rated current [▶S-0-0196◀](#).

If the load limit of the motor is exceeded, the b maXX controller generated error 205 and sets bit 0 in class 1 diagnostic ([▶S-0-0011◀](#)).

The bit overload warning in class 2 diagnostic ([▶S-0-0310◀](#)) is not supported.

S-0-0116	Resolution feedback 1 (motor feedback)	1 to 524288
-	- (CP3, CP4)	2 bytes
-	P-0-0950	1024
<p>The parameter displays the signal periods or increments per motor revolution of the motor encoder. For encoders with EnDat[®] or Hiperface[®] interface this value is read automatically while encoder initialization.</p> <p>The setting of this parameter is described in the parameter manual of the b maXX controller.</p>		
S-0-0118	Resolution feedback 2 (external feedback)	1 to 524288
-	- (CP3, CP4)	2 bytes
-	-	1024
<p>The parameter displays the signal periods or increments per motor revolution of the optional, external encoder. For encoders with EnDat[®] or Hiperface[®] interface this value is read automatically while encoder initialization.</p> <p>The setting of this parameter is described in the parameter manual of the b maXX controller.</p>		
S-0-0119	Current loop proportional gain 2	0 to 10000.00
-	x	4 bytes
100:1	P-0-0138	10.00
<p>Defines the proportional gain of the Id current controller (flux-building current), resolution 0.01 V/A.</p> <p>Example scaling: 4500 (Sercos) ⇒ 45.00 V/A (P-0-0138 b maXX controller)</p>		
S-0-0120	Current loop integral action time 2	0 to 65535
-	x	2 bytes
1:1	P-0-0139	5000
<p>Defines the integral action time of the Id current controller in μs.</p> <p>Example scaling: 8183 (Sercos) ⇒ 8.183 ms (P-0-0139 b maXX controller)</p>		

S-0-0121	Load gear input revolutions	1 to $2^{32}-1$
-	- (CP4)	4 bytes
-	P-0-0681	1
<p>The gear ratio of a mechanical gear between motor and load can be set in ▶S-0-0121◀ and ▶S-0-0122◀.</p> <p>The number of motor revolutions (gear input, motor side) is set in ▶S-0-0121◀, resulting in a integer number of revolutions on the gear output (load side) (▶S-0-0122◀).</p> <p>Changes in this parameter are active after a reboot of the b maXX controllers only!</p>		
S-0-0122	Load gear output revolutions	1 to $2^{32}-1$
-	- (CP4)	4 bytes
-	P-0-0682	1
<p>The integer number of motor revolutions at the gear output (load side) are set in ▶S-0-0122◀, generated by the number of motor revolutions on the gear input (▶S-0-0121◀).</p> <p>Changes in this parameter are active after a reboot of the b maXX controllers only!</p>		
S-0-0123	Feed constant	1 to $2^{32}-1$
-	- (CP4)	4 bytes
-	-	10000
<p>The feed constant describes the machine element which converts a rotatory motion into a linear motion. The feed constant indicates the linear distance during one revolution of the machine element.</p>		
S-0-0124	Standstill window	0 to $2^{31}-1$
-	x	4 bytes
G	P-0-0010	0
<p>The standstill window describes the amount of the deviation of the speed from 0. If the speed actual value is within the standstill window, the drive sets the status $n_{\text{actual}} = 0$ (▶S-0-0331◀), bit 1.</p> <p>Scaling must be considered (also see scaling ▶Speed data◀ from page 26).</p>		
S-0-0125	Velocity threshold n_x	0 to $2^{31}-1$
-	x	4 bytes
G	P-0-0018, P-0-0019	0
<p>If the speed actual value n_x exceeds this threshold n_{actual} the drive sets status $n_{\text{actual}} < n_x$ (▶S-0-0332◀) into class 3 diagnostic (▶S-0-0013◀), bit 2.</p> <p>Scaling must be considered (also see scaling ▶Speed data◀ from page 26).</p>		

S-0-0126	Torque threshold M_x	0 to 65535
-	x	2 bytes
D	P-0-1122	0

If the absolute value of the torque actual value is higher than the threshold M_x , the drive sets the bit 3 $|M_{\text{actual}}| > |M_x|$ ([▶S-0-0333◀](#) and [▶S-0-0013◀](#)) in class 3 diagnostic.

Scaling must be considered

(also see scaling [▶Torque and force data◀](#) from page 30).

S-0-0127	CP3 transition check	- to -
-	-(CP3, CP4)	2 bytes
-	-	0

This parameter has no function at SoE. The change of phases is done via EtherCAT state machine in application layer at SoE.

S-0-0128	CP4 transition check	- to -
-	-(CP2, CP3, CP4)	2 bytes
-	-	0

This parameter has no function at SoE. The change of phases is done via EtherCAT state machine in application layer at SoE.

S-0-0129	Manufacturer class 1 diagnostic	- to -
-	-	2 bytes
-	-	0

This parameter contains the manufacturer-specific error code of the b maXX controller (see parameter manual b maXX controller 5000 or 3300). Furthermore in class 1 diagnostic [▶S-0-0011◀](#) bit 15 is set.

Manufacturer-specific errors can be reset via command „Reset class 1 diagnostic“ ([▶S-0-0099◀](#)).

15	14	13	12	11	10	9	8	7	6	5	4	3	2	1	0
----	----	----	----	----	----	---	---	---	---	---	---	---	---	---	---

--	--	--	--	--	--	--	--	--	--	--	--	--	--	--	--

			x	x	x	x	x	x	x	x	x	x	x	x	x
--	--	--	---	---	---	---	---	---	---	---	---	---	---	---	---

--	--	--	--	--	--	--	--	--	--	--	--	--	--	--	--

--	--	--	--	--	--	--	--	--	--	--	--	--	--	--	--

b maXX controller error code of the chronologically first occurred error

x x x Number of active manufacturer-specific errors, a maximum of 7 errors are displayed

S-0-0130

CR
L

Probe value 1 positive edge

-
P-0-0704, P-0-0705

-2^{31} to $+2^{31}-1$
4 bytes
0

The probe values of the positive edge of the probe cycle are written to this parameter.
Also see command [▶Touch probe◀](#) from page 53.

Scaling must be considered
(also see scaling [▶Position data◀](#) from page 23).

S-0-0131

CR
L

Probe value 1 negative edge

-
P-0-0706, P-0-0707

-2^{31} to $+2^{31}-1$
4 bytes
0

The probe values of the negative edge of the probe cycle are written to this parameter.
Also see command [▶Touch probe◀](#) from page 53.

Scaling must be considered
(also see scaling [▶Position data◀](#) from page 23).

S-0-0132

CR
L

Probe value 2 positive edge

-
P-0-0720, P-0-0721

-2^{31} to $+2^{31}-1$
4 bytes
0

The probe values of the positive edge of the probe cycle are written to this parameter.
Also see command [▶Touch probe◀](#) from page 53.

Scaling must be considered
(also see scaling [▶Position data◀](#) from page 23).

S-0-0133

CR
L

Probe value 2 negative edge

-
P-0-0723, P-0-0724

-2^{31} to $+2^{31}-1$
4 bytes
0

The probe values of the negative edge of the probe cycle are written to this parameter.
Also see command [▶Touch probe◀](#) from page 53.

Scaling must be considered
(also see scaling [▶Position data◀](#) from page 23).

S-0-0134**Master control word**

- to -
2 bytes
0

With this parameter the cyclically transmitted master control word can be read via the service channel. The writing of the master control word is not possible via the service channel.

The parameter is displayed graphically in ProDrive menu Diagnostic/Sercos status.

15	14	13	12	11	10	9	8	7	6	5	4	3	2	1	0
															x
										x	x	x	x	x	Reserved
									x	Realtime control bit 1					
								x	Realtime control bit 2						
						0	0	Primary operation mode (▶S-0-0032◀)							
						0	1	Secondary operation mode 1 (▶S-0-0033◀)							
						1	0	Secondary operation mode 2 (▶S-0-0034◀)							
						1	1	Secondary operation mode 3 (▶S-0-0035◀)							
			x	x	x	Reserved									
		x	Halt drive ¹⁾												
		1 ⇒ 0: Stop with a permitted deceleration, only possible if bit 14 and 15 are set													
		0 ⇒ 1: Restart of the drive													
	x	0 ⇒ 1: Enable drive													
	1 ⇒ 0: Drive not enabled ²⁾														
x	0 ⇒ 1: Drive ON														
1 ⇒ 0: Drive OFF ³⁾															

¹⁾ In operation modes „torque control“ and „searching notch position“ the bit 13 „halt drive“ is not available, i. e. the speed controller must be active to enable a stop. Furthermore the stop is not available if command „spindle positioning“ ([▶S-0-0152◀](#)) is active.

²⁾ The falling edge of bit 14 „drive disabling“ switches-off the torque immediately only if in P-0-0312 DISABLE reaction the value 0 is set (= disable drive immediately). The default value of this parameter is 0.

³⁾ The falling edge of bit 15 „drive off“ starts an optimized controlled stop only if bit 14 is set and P-0-0311 SHUTDOWN reaction is 2 (stop on quick stop ramp). The default value of this parameter is 0 (= drive disabling immediately).

Active deceleration values of bit 13 „Halt drive“:

Operation mode	Operation mode code	Active deceleration value
Speed control	0x0002	P-0-0336 Ramp down time
Position control	0x0003, 0x0004, 0x0005	▶S-0-0372◀ Halt drive deceleration bipolar
Drive internal interpolation	0x0013	▶S-0-0359◀ Positioning deceleration
Synchronous mode	0x8001	P-0-0547 Synchronous deceleration
Position target setting	0x8003	▶S-0-0359◀ Positioning deceleration
Speed setting 1	0x8004	P-0-0336 Ramp down time
Manual mode	0x8005	▶S-0-0359◀ Positioning deceleration
Homing, drive controlled	0x8007	▶S-0-0372◀ Halt drive deceleration bipolar

NOTE

Different reactions to the state transitions 1 (bit 14 1 ⇒ 0) and 2 (bit 15 1 ⇒ 0) can be set via parameter P-0-0311 DISABLE reaction and P-0-0312 SHUTDOWN reaction (see [▶State machine◀](#) from page 20).

The permitted deceleration values must be set via the P parameters shown in the table.

P-0-0311/ P-0-0312	Description
0	Disable drive immediately
1	Stop with ramp down (P-0-0336)
2	Stop with quickstop ramp (P-0-0337)
3	Stop with current limit

S-0-0135**Drive status word**- to -
2 bytes
0

With this parameter the cyclically transmitted status word can be read via the service channel.

The parameter is displayed graphically in ProDrive menu Diagnostic/Sercos status.

15	14	13	12	11	10	9	8	7	6	5	4	3	2	1	0	
															x	Toggle bit
													x	x		Reserved
													0			Drive ignores set values (e.g. during halt drive, drive-controlled functions etc.)
													1			Drive follows the set values
											x					Reserved
										x						Reserved ⇒ Command change bit is not supported using SoE
									x							Realtime status bit 1
								x								Realtime status bit 2
					0	0	0									Primary operation mode active
					0	0	1									Secondary operation mode 1 active
					0	1	0									Secondary operation mode 2 active
					0	1	1									Secondary operation mode 3 active
								Other								Reserved
				x												1: Message class 3 diagnostic available (C3D, ▶S-0-0013◀)
			x													1: Warning class 2 diagnostic available (C2D, ▶S-0-0012◀)
		x														1: Error class 1 diagnostic available (C1D, ▶S-0-0011◀)
																Status ready-for-operation
0	0															Drive not ready for power switch-on
0	1															Drive ready for power switch-on
1	0															Drive ready and power supply voltage is available, drive is torque-free, pulses inhibited, see note below!
1	1															Drive in operation, drive enabled, pulses enabled

NOTE:

In spite of set pulse enabling a drive with an asynchronous machine stays for the period of building-up field in state „Drive ready and power supply available“ (bit 14 -15 = 10)! Details see parameter manual of controller b maXX 5000 bzw. 3300.

S-0-0139	Park axis procedure command	- to -
-	- (CP2, CP3)	2 bytes
-	-	0

If the command park axis is set and is enabled, all the monitoring of the encoder actual value processing is switched off. This concerns the position control, the encoder monitoring (feedback hardware) and the monitoring of the positioning window ([▶S-0-0057◀](#)). If the command is activated, the drive does not generate a C1D error ([▶S-0-0011◀](#)). The status of the position actual values ([▶S-0-0403◀](#)) is reset by the drive.

The state „Parking axis“ is shown via the display with „P“.

The command is positively accepted, if the monitoring was switched off (as mentioned above). If the command is reset, all mentioned monitoring are switched on again. In order to synchronize the home position again, the control must execute homing.

S-0-0140	Controller type	- to -
-	-	1 Byte, variable
-	-	-

The controller type contains the company's name and the controller type of the manufacturer. It is permitted to be used for diagnostics only. It is not allowed to use it for identification by the master. Example: „Baumueller b maXX 5325“.

S-0-0141	Motor type	- to -
-	- x	1 Byte, variable
-	P-0-0832	-

The motor type contains the company's name and the motor type of the manufacturer. It is permitted to be used for diagnostics only. It is not allowed to use it for identification by the master. Example: „DSD-028 M 654“.

S-0-0142	Application type	- to -
-	-	1 Byte, variable
-	P-0-0262	-

A description for using of the axis can be set in this parameter. Example: „Main spindle“, „Rotational axis“.

S-0-0143	Sercos Interface Version	- to -
-	-	1 Byte, variable
-	-	-

Sercos interface version which is supported by the slave.

S-0-0144

CR

-

Signal statusword

-

-

- to -

2 bytes, variable

0

Messages can be transmitted in realtime from the drive to the control via this statusword. For these purposes the signal statusword must be inserted in the AT as cyclical data. The bits in the signal statusword are defined via the configuration list of the signal statusword ([▶S-0-0026◀](#)).

The bit No. of the source parameter is set in [▶S-0-0328◀](#). Default value is bit No. 0.

S-0-0145

CW

-

Signal controlword

x

-

- to -

2 bytes, variable

0

Messages can be transmitted in realtime from the drive to the control via the signal controlword. For this purpose the signal controlword must be inserted in the MDT as cyclical data. The bits in the signal controlword ([▶S-0-0027◀](#)) are defined via the configuration list of the signal controlword.

S-0-0146

-

-

Control unit controlled homing procedure comm.

- (CP2, CP3)

-

- to -

2 bytes

0

If the command control unit controlled homing is set and enabled by the master the drive must react to the programmed or allocated signals ([▶S-0-0407◀](#) homing enable, [▶S-0-0400◀](#) home switch, reference marker of the encoder system).

When the drive reaches the appropriate marker pulse of the encoder system, the drive saves the momentary position actual value of the according marker position ([▶S-0-0173◀](#)). Furthermore the drive sets the bit „reference marker latched“ ([▶S-0-0408◀](#)) and acknowledges the command as performed correctly.

When an error of C1D occurs, the command is stopped with error.

Also see command [▶Homing◀](#) from page 47.

15	14	13	12	11	10	9	8	7	6	5	4	3	2	1	0
Reserved															
															0
															1
														0	Interrupt command execution
														1	Execute command execution

NOTE:

The command cannot be executed on both axes of a double axis simultaneously (see [▶Supported commands◀](#) from page 44).

S-0-0147

-
-

Homing parameter

X
-

- to -
2 bytes
0

This parameter determines the requirements for drive-controlled and control unit controlled homing.

15	14	13	12	11	10	9	8	7	6	5	4	3	2	1	0	
Reserved																
															0	Positive: Moving in direction of increasing position actual values
															1	Negative: Moving in direction of decreasing position actual values
															0	First zero pulse after the positive edge of the home switch (▶S-0-0400◀)
															1	First zero pulse after the negative edge of the home switch ▶S-0-0400◀)
															0	Reference switch (▶S-0-0400◀) is connected to the master ¹⁾
															1	Reference switch (▶S-0-0400◀) is connected to the drive ¹⁾
															0	Homing with motor encoder ¹⁾
															1	Homing with external encoder ¹⁾
																For control unit controlled homing only
															0	Home switch and homing enabling
															1	Only homing enabling
															0	Home switch is evaluated
															1	Home switch is not evaluated
															0	Reference marker is evaluated
															1	Reference marker is not evaluated

¹⁾ NOTE:

The bit 2 must be set for drive-controlled homing (command 148)! Bit 4 is only evaluated at control unit controlled homing (command 146).

Also see command [▶Homing◀](#) from page 47.

S-0-0148

Drive-controlled homing procedure command - to -
 - (CP2, CP3) 2 bytes
 - 0

When the master sets and enables the drive controlled homing procedure command, the drive automatically activates the drive internal position control and accelerates to the homing speed ([▶S-0-0041◀](#)) taking the homing acceleration ([▶S-0-0042◀](#)) into account. The drive resets the bit „status position actual values“ ([▶S-0-0403◀](#)). Further options for the homing procedure are programmed in the homing parameter ([▶S-0-0147◀](#)). All changes of the cyclic set values are ignored as long as the command is active.

After passing over the reference marker, the drive decelerates with homing acceleration to standstill. The command drive-controlled homing is successfully completed when the drive has stopped and the position actual value is referred to the reference point of the machine. The drive shows this by setting the bit „position actual values status“ ([▶S-0-0403◀](#)).

The drive internally calculates position set value ([▶S-0-0047◀](#)) related to the position encoder reference marker. The control reads the position set value via the service channel and sets its position set value system to this position set value. After that the control deletes the command and the drive follows the set values of the control.

An interruption of this command leads to a position actual value that is not referenced to the reference marker. The bit „Status position actual values“ is not set. The command is stopped with an error, if an error in C1D occurs.

Also see command [▶Homing◀](#) from page 47.

15	14	13	12	11	10	9	8	7	6	5	4	3	2	1	0	
Reserved																
															0	Reset command in drive
															1	Set command in drive
														0	Interrupt command execution	
														1	Execute command execution	

S-0-0152	Position spindle procedure command	- to -
-	- (CP2, CP3)	2 bytes
-	-	0

Also see [▶Command Spindle positioning◀](#) from page 56.

This command switches the drive to the internal position control with spindle positioning speed ([▶S-0-0222◀](#)) and, if necessary, references the spindle. If the command is activated, all changes of the cyclical set value are ignored.

Dependent of spindle positioning parameter ([▶S-0-0154◀](#)) the drive positions the spindle with spindle positioning speed ([▶S-0-0222◀](#)) absolutely to the position, which was set ([▶S-0-0153◀](#)) or turns the spindle relatively (increments) ([▶S-0-0180◀](#)). If the drive controller reaches the selected set value, the drive sets the status „Target position reached“ ([▶S-0-0342◀](#)). The status „In position“ ([▶S-0-0336◀](#)) and „In position coarse“ ([▶S-0-0341◀](#)) is updated by the drive.

While the command is active, the drive rotates in position control towards each new set value ([▶S-0-0153◀](#) or [▶S-0-0180◀](#)), which is transmitted via the service channel. If the controller withdraws the command, the drive switches into the operating mode, which was set in the control word, again.

S-0-0153	Spindle angle position	-2^{31} to $2^{31}-1$
-	x	4 bytes
L	P-0-0562	0

Also see [▶Command Spindle positioning◀](#) from page 56.

This parameter shows the absolute spindle angle position relative to reference marker. The parameter is only active in connection with the command spindle positioning ([▶S-0-0152◀](#)).

Scaling must be considered unconditionally
(also see scaling [▶Position data◀](#) from page 23).

S-0-0154	Spindle positioning parameter	- to -
-	x	2 bytes
-	-	0

Also see [▶Command Spindle positioning◀](#) from page 56.

If the speed set value is equal to 0 and the command spindle positioning is activated, the speed direction can be selected here in order to reach the target angle. If the speed set value is not equal 0, the speed direction is retained, in order to reach the target angle.

15	14	13	12	11	10	9	8	7	6	5	4	3	2	1	0	
Reserved																
														0	0	Speed direction clockwise
														0	1	Speed direction counterclockwise
														1	0	Shortest distance
														1	1	Reserved
													0			Spindle target angle ▶S-0-0153◀
													1			Spindle relative offset ▶S-0-0180◀

S-0-0155	Friction compensation	0 to $2^{15}-1$
-	X	2 bytes
D	P-0-1514, P-0-1516	0
<p>The friction compensation is overlaid additionally to the torque set value. During addition, the friction torque compensation and torque command value need to have the same sign. The inclusion of friction torque compensation helps compensating the frictional grip during acceleration from standstill, and during reversals.</p>		
S-0-0157	Velocity window	0 to $+2^{31}-1$
-	X	4 bytes
G	P-0-0015, P-0-0016	0
<p>The velocity window is compared with the sum (according to amount) of all speed set values. If the speed actual value is within the calculated speed window, the message „N_{actual} = N_{set}“ is set in C3D (▶S-0-0013◀, bit 0 or ▶S-0-0330◀).</p> <p>In addition for this message a relative window can be defined via ▶S-0-0272◀ Speed window percentage. Further details see ▶S-0-0330◀.</p> <p>Scaling must be considered (also see scaling ▶Speed data◀ from page 26).</p>		
S-0-0159	Monitoring window	0 to $+2^{31}-1$
-	X	4 bytes
L	P-0-1142, P-0-1145	0
<p>The monitoring window sets the maximum position deviation of the position actual value and the interpolated position set value ¹⁾. If position deviation exceeded the monitoring window, the drive sets the error „excessive control deviation“ into C1D (▶S-0-0011◀), bit 11.</p> <p>¹⁾ Interpolated position set value = effective position set value on position controller input</p> <p>Scaling must be considered (also see scaling ▶Position data◀ from page 23).</p> <p>NOTE: The function is named deviation error monitoring in the b maXX controller. See also parameter manual of the controller, chapter „Position deviation monitoring“.</p>		

S-0-0160

-
-

Acceleration data scaling type

- (CP4)
-

- to -
2 bytes
0xA

By means of the scaling type different scaling types can be set.

15	14	13	12	11	10	9	8	7	6	5	4	3	2	1	0	
Reserved																
													0	0	0	Not scaled
													0	0	1	Linear scaling
													0	1	0	Rotary scaling
													0	1	1	Reserved
													0	Preferred scaling		
													1	Parameter scaling		
												0	Unit at linear scaling „meter“			
													Unit at rotary scaling „radian“			
												1	Unit at linear scaling „inch“			
													Unit at rotary scaling „reserved“			
											0	Time unit second				
											1	Reserved				
										0	Data reference at the motor shaft					
										1	Data reference at the load					

See scaling [▶Acceleration and jerk data◀](#) from page 28.

S-0-0161

-
-

Acceleration data scaling factor

- (CP4)
-

1 to $2^{16}-1$
2 bytes
1

In this parameter the scaling factor for all acceleration data in this drive is determined.

See scaling [▶Acceleration and jerk data◀](#) from page 28.

S-0-0162**Acceleration data scaling exponent**

-9 to 3

- (CP4)

2 bytes

-

-3

In this parameter the scaling factor for all acceleration data in this drive is determined.

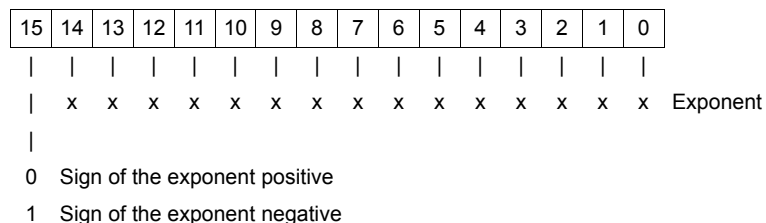

See scaling [►Acceleration and jerk data◄](#) from page 28.

S-0-0163**Weight counterbalance** -2^{15} to $2^{15} - 1$

- X

2 Bytes

- P-0-1234

0

The parameter can be used for setting an „electronic“ weight counterbalance (torque or force) at vertical mounted axes („hanging axis“). Therewith the dropping of the load can be limited when enabling drive and disabling the brake. The required torque for the actual load can be read at enabled drive in [►S-0-0084◄](#) Torque actual value.

This parameter is only active

- if the motor is equipped with a brake,
- if the braking management of the b maXX controller is working in automatic mode (P-0-1230),
- a speed or position controlled operation mode is active and
- the motor operation mode (P-0-0115) is set with encoder.

For details of brake management see parameter manual b maXX 5000 or 3000, chapter brake management.

Scaling must be considered

(also see scaling [►Torque and force data◄](#) from page 30).

S-0-0169

-
-

Probe control parameter

X
-

- to -
2 bytes
0

This parameter determines which edges and probes are activated for the probe cycle procedure (also see [▶Touch probe◀](#) from page 53).

15	14	13	12	11	10	9	8	7	6	5	4	3	2	1	0
Reserved															
														0	Probe 1 pos. edge inactive
														1	Probe 1 pos. edge active
													0	Probe 1 neg. edge inactive	
													1	Probe 1 neg. edge active	
												0	Probe 2 pos. edge inactive		
												1	Probe 2 pos. edge active		
											0	Probe 2 neg. edge inactive			
											1	Probe 2 neg. edge active			

S-0-0170

-
-

Probe cycle procedure command

-(CP2)
-

- to -
2 bytes
0

When the master sets and enables the probe cycle procedure command, the drive reacts on the following parameters:

- Probe 1/2 enable ([▶S-0-0405◀](#), [▶S-0-0406◀](#))
- Probe 1/2 ([▶S-0-0401◀](#), [▶S-0-0402◀](#))
- Probe control parameter ([▶S-0-0169◀](#))

While the command is active the control can start multiple measurements. The command is reset by the control if no further measurements are desired (also see [▶Touch probe◀](#) from page 53).

15	14	13	12	11	10	9	8	7	6	5	4	3	2	1	0
Reserved															
												0	Reset command in drive		
												1	Set command in drive		
											0	Interrupt command execution			
											1	Execute command execution			

NOTE:

The command cannot be executed on both axes of a double axis.

S-0-0171

Calculate displacement procedure command - to -
 - (CP2, CP3) 2 bytes
 - 0

When the master sets and enables the procedure command „calculate displacement“ the drive determines from the parameters.

- Reference distance 1 or 2 ([▶S-0-0052◀](#), [▶S-0-0054◀](#))
- Marker position A ([▶S-0-0173◀](#))

the displacement between old and new (referenced) set-/actual system.

The calculated displacement is saved in the parameters

- Displacement parameter 1 ([▶S-0-0175◀](#), motor encoder) and
- Displacement parameter 2 ([▶S-0-0176◀](#), external encoder).

In homing parameter ([▶S-0-0147◀](#), bit 3) is selected, for which encoder the displacement is calculated.

When the drive recognizes the displacement as invalid, the command results in an error (also see [▶Supported commands◀](#) from page 44).

15	14	13	12	11	10	9	8	7	6	5	4	3	2	1	0
Reserved															
														0	Reset command in drive
														1	Set command in drive
													0	Interrupt command execution	
													1	Execute command execution	

S-0-0172

Displacement to the referenced system command - to -
 - (CP2, CP3) 2 bytes
 - 0

When the master sets and enables the command „Displacement to the reference system“ the encoder switches to the referenced position actual value system and marks this by simultaneously setting of the bit „status position actual values“ ([▶S-0-0403◀](#)). To inform the drive about the switching in realtime, the bit „status position actual values“ has to be assigned to a real control bit.

During the active command the control switches to the control of the referenced position set value system and marks this by simultaneously setting of the bit „status position set values“ ([▶S-0-0404◀](#)). To inform the drive about the switching in realtime, the bit „status position set values“ has to be assigned to a realtime control bit.

The command has been correctly completed if the bits „status position actual values“ and „status position set values“ have been set. The correct order, in which the bits are to be set is not determined (also see [►Supported commands◄](#) from page 44).

15	14	13	12	11	10	9	8	7	6	5	4	3	2	1	0
Reserved															
														0	Reset command in drive
														1	Set command in drive
													0	Interrupt command execution	
													1	Execute command execution	

S-0-0173

-
L

Marker position A

-
-

$-2^{31}+1$ to $2^{31}-1$
4 bytes
0

If the drive recognizes the reference marker of the position encoder 1 or 2 during homing, it saves the present position actual value 1 or 2, which is not referenced, into the marker position A.

Distance coded measurement systems are not supported.

Scaling must be considered

(also see scaling [►Position data◄](#) from page 23).

S-0-0175

-
L

Displacement parameter 1

-
-

$-2^{31}+1$ to $2^{31}-1$
4 bytes
0

If the command calculate displacement ([►S-0-0171◄](#)) is active, the drive calculates the difference between the old position actual value and the new position actual value. The drive saves the difference as the „displacement parameter 1" if motor encoder is selected.

Scaling must be considered

(also see scaling [►Position data◄](#) from page 23).

S-0-0176

-
L

Displacement parameter 2

-
-

$-2^{31}+1$ to $2^{31}-1$
4 bytes
0

the command calculate displacement ([►S-0-0171◄](#)) is active, the drive calculates the difference between the old position actual value and the new position actual value. The drive saves the difference as the „displacement parameter 2" if external encoder is selected.

Scaling must be considered

(also see scaling [►Position data◄](#) from page 23).

S-0-0177-
L**Absolute distance 1**-
- $-2^{31}+1$ to $2^{31}-1$
4 bytes
0

This parameter describes the distance between the machine zero point and the zero point of the absolute measurement system at the motor.

Scaling must be considered
(also see scaling [►Position data◄](#) from page 23).

S-0-0178-
L**Absolute distance 2**-
- $-2^{31}+1$ to $2^{31}-1$
4 bytes
0

This parameter describes the distance between the machine zero point and the zero point of an absolute measurement system at the machine (external encoder).

Scaling must be considered
(also see scaling [►Position data◄](#) from page 23).

S-0-0179CR
-**Probe status**-
-- to -
2 bytes
0

If the drive saves one or more measured values while the command probe cycle is active ([►S-0-0170◄](#)) it simultaneously sets the assigned bit in the probe status.

If „probe 1 enable“ ([►S-0-0405◄](#)) is reset by the control unit, the drive resets bit 0 and bit 1 of probe status.

If „probe 2 enable“ ([►S-0-0406◄](#)) is reset by the control unit, the drive resets bit 2 and bit 3 of probe status.

The drive resets all bits in the probe status when the control unit resets the „probe cycle procedure command“ ([►S-0-0170◄](#)).

15	14	13	12	11	10	9	8	7	6	5	4	3	2	1	0
Reserved															
														0	Probe 1 positive (►S-0-0409◄) not latched
														1	Probe 1 positive (►S-0-0409◄) latched
													0	Probe 1 negative (►S-0-0410◄) not latched	
													1	Probe 1 negative (►S-0-0410◄) latched	
												0	Probe 2 positive (►S-0-0411◄) not latched		
												1	Probe 2 positive (►S-0-0411◄) latched		
											Probe 2 negative (►S-0-0412◄) not latched				
											Probe 2 negative (►S-0-0412◄) latched				

S-0-0180	Spindle relative offset	-2^{31} to $2^{31}-1$
-	X	4 bytes
L	P-0-0567	0

Also see [▶Command Spindle positioning◀](#) from page 56.

The parameter is only active in connection with the spindle positioning command [▶S-0-0152◀](#). The relative offset spindle positioning is added to the absolute positioning value. The parameter is used to drive the spindle a certain number of revolutions.

Scaling must be considered
(also see scaling [▶Position data◀](#) from page 23).

S-0-0181	Manufacturer class 2 diagnostic	- to -
-	-	2 bytes
-	-	0

This parameter displays manufacturer-specific warnings. If a warning is set in [▶S-0-0181◀](#) the bit 15 of [▶S-0-0012◀](#) C2D is set additionally.

The parameter shows the manufacturer-specific warning code of the b maXX controller (see parameter manual b maXX controller 5000 or 3300).

The parameter is defined as follows:

15	14	13	12	11	10	9	8	7	6	5	4	3	2	1	0
			x	x	x	x	x	x	x	x	x	x	x	x	x
			b maXX controller warning code of the chronically last occurred warning												
x	x	x	No. of present manufacturer-specific warnings, display is limited to max. 7												

S-0-0182	Manufacturer class 3 diagnostic	- to -
-	-	2 bytes
-	-	0

This parameter displays manufacturer-specific warnings.

No messages are displayed at the moment.

S-0-0183	Synchronization velocity window	0 to $2^{31}-1$
-	-	4 bytes
G	P-0-0545	10000

The parameter sets the window for monitoring the speed synchronization between master and slave axis. The window is symmetrically set on the speed set value of the master axis.

The parameter is used at the manufacturer-specific operation mode „synchronous mode“, which provides a speed synchronization of a slave axis to a master axis.

The implementation of this via command „Drive-controlled synchronization“ (S-0-0223) is not supported at the moment.

Scaling must be considered
(also see scaling [►Speed data◄](#) from page 26).

S-0-0185	Length of the configurable data record in the AT	- to -
-	-	2 bytes
-	-	64

In the operation data of this IDN the drive displays the maximum length in bytes which can be processed in the configurable data of the AT.

S-0-0186	Length of the configurable data in the MDT	- to -
-	-	2 bytes
-	-	64

In the operation data of this IDN the drive displays the maximum length in bytes which can be processed in the configurable data of the MDT.

S-0-0187	IDN list of the configurable data in the AT	- to -
-	-	2 bytes, variable
-	-	*

* Standard value without length specification: **S-0-0011**, **S-0-0012**, **S-0-0013**, **S-0-0036**, **S-0-0037**, **S-0-0040**, **S-0-0047**, **S-0-0051**, **S-0-0053**, **S-0-0080**, **S-0-0081**, **S-0-0084**, **S-0-0108**, **S-0-0130**, **S-0-0131**, **S-0-0132**, **S-0-0133**, **S-0-0144**, **S-0-0179**, **S-0-0189**, **S-0-0258**, **S-0-0259**, **S-0-0260**, **S-0-0359**, **S-0-0347**, **S-0-0372**, **S-0-0380**, **S-0-0385**, **S-0-0430**,
P-0-0678, P-0-0401, P-0-0685, P-0-0687

This list consists of the IDNs of operation data which can be processed by the drive cyclically as actual values.

Parameter [►S-0-0053◄](#) is on available using devices with 2 encoder inputs per axis.

S-0-0188	IDN list of the configurable data in the MDT	- to - 2 bytes, variable *
-	-	
-	-	
	* Standard value without length specification: S-0-0036 , S-0-0037 , S-0-0041 , S-0-0042 , S-0-0047 , S-0-0048 , S-0-0080 , S-0-0081 , S-0-0082 , S-0-0083 , S-0-0091 , S-0-0092 , S-0-0108 , S-0-0145 , S-0-0258 , S-0-0259 , S-0-0260 , S-0-0359 , S-0-0372 , S-0-0405 , S-0-0406	
	This list consists of the IDNs of operation data which can be processed by the drive cyclically as set values.	
S-0-0189	Position error	-2^{31} to $2^{31}-1$
CR	-	4 bytes
L	P-0-0075	0
	In this parameter the drive saves the present difference between the position set value and the position actual value, which is relevant for the control.	
	Calculation of the position deviation:	
	Position error = Position set value - Position actual value 1 or 2	
	Scaling must be considered (also see scaling ▶Position data◀ from page 23).	
S-0-0192	IDN list of all backup operation data	- to - 2 bytes, variable *
-	- (CP3, CP4)	
-	-	
	* Standard value: 10, 128, S-0-0001 , S-0-0015 , S-0-0016 , S-0-0024 , S-0-0032	
	The parameter list contains all parameter numbers of the drive data, which are loaded in the drive, in order to guarantee a correct operation. The master uses this list in order to generate a backup copy of the drive parameters.	
	It is forbidden to add following parameters to this IDN list:	
	<ul style="list-style-type: none"> • ▶S-0-0192◀; the value is stored automatically • Parameters readable only • Not existing parameters • Command parameters • P parameters and S parameters with P parameter allocation; the values of this parameters are stored in the controller generally if the P parameter is storable. For details see parameter manual of the b maXX controller. 	
	The check whether the parameter numbers set in ▶S-0-0192◀ are valid is done when executing command 263 or while initialization at switching on the device. If an invalid parameter number is recognized, the loading procedure is aborted and an error message is generated.	
	Please consider notes at ▶S-0-0263◀ and ▶S-0-0264◀ .	
	NOTE:	
	The S-0-0269 Storage mode is not supported by the b maXX controller. That means parameter settings via the service channel are written to the working memory only and the settings are lost in case of a voltage failure (24 V). The storage of the parameter settings is done via command 264 only.	

S-0-0193

-	Positioning jerk	1 to $2^{32}-1$
-	X	4 bytes
-	P-0-0605, P-0-0505	1

The position jerk contains the maximum value of changes in acceleration in operation modes interpolation, position target setting and manual mode.

The deactivation of the position jerk limitation must be done via P-0-0611 bit 1 and 2 (=0) and P-0-0501 bit 1 = 0.

Scaling must be considered

(also see scaling [▶Acceleration and jerk data◀](#) from page 28).

S-0-0196

-	Motor rated current	0 to 6553.500
-	X	4 bytes
1000:1	P-0-0839	3.500

The motor rated current is the current at which the motor provides the nominal torque according to the motor data sheet. For all asynchronous motors this parameter is used as a reference for all torque data and for determining motor related current values.

The parameter is displayed in resolution of 0.001 A.

S-0-0197

-	Coordinate setting procedure command	- to -
-	- (CP2, CP3)	2 bytes
-	-	0

After activation of the command setting coordinate system, the drive sets the programmed initial coordinate value [▶S-0-0198◀](#) into the position internal set value. Furthermore the drive calculates all absolute values (position limits, a. s. o.), regarding the initial coordinate value.

The position actual value status [▶S-0-0403◀](#) and the position set values [▶S-0-0404◀](#) are not affected by this command.

The command has been executed successfully if all necessary calculations are finished if the current coordinate displacement [▶S-0-0383◀](#) was calculated and the drive's coordinate system is referred to the initial coordinate value [▶S-0-0198◀](#).

Before the control resets the command, it must also set its coordinate system to the same value the drive used. After resetting of the command the drive can be enabled again.

The command is stopped with an error if the drive detects an error during command-specific calculations.

NOTE:

The command can be executed only with disabled and standstill drive!

Before starting the command the drive state [▶S-0-0135◀](#) and the Nact=0 message [▶S-0-0331◀](#) is checked. Furthermore the bit „Drive ON“ in master control word [▶S-0-0134◀](#) must not be set. The command is canceled and an error message is generated if not all three conditions are met.

S-0-0198	Start value of coordinate system	-2 ³¹ -1 to +2 ³¹ -1
-	X	4 bytes
L	-	0
<p>The drives coordinate system is set to the value programmed as the start value coordinate value during the „setting coordinate system“ command ▶S-0-0197◀ of the drive.</p> <p>Scaling must be considered (also see scaling ▶Position data◀ from page 23).</p>		
S-0-0200	Amplifier warning temperature	0 to 150.0
-	X	2 bytes
10:1	-	0
<p>This parameter is implemented only for compatibility reasons, because there is no adequate allocation in the b maXX controller.</p>		
S-0-0201	Motor warning temperature	0 to 185.0
-	X	2 bytes
10:1	P-0-0823, P-0-0824	130.0
<p>If motor temperature exceeds the specified value the drive sets the bit motor temperature warning in class 2 diagnostic (▶S-0-0012◀), bit 2.</p> <p>The setting of a warning threshold hysteresis is possible via P-0-0825.</p>		
S-0-0202	Cooling error warning temperature	0 to 255.0
-	X	2 bytes
10:1	P-0-0936	55.0
<p>When an error occurs in the cooling system (e. g. the temperature in the control cabinet is higher than the cooling error warning temperature) the drive sets the bit cooling error warning into class 2 diagnostic (▶S-0-0012◀), bit 3.</p>		
S-0-0203	Amplifier shut-down temperature	0 to 150.0
-	X	2 bytes
10:1	-	0
<p>This parameter is implemented only for compatibility reasons, because there is no adequate allocation in the b maXX controller.</p>		
S-0-0204	Motor shut-down temperature	0 to 250.0
-	X	2 bytes
10:1	P-0-0857	150.0
<p>If motor temperature exceeds the specified value the drive sets the bit motor temperature shutdown in class 1 diagnostic (▶S-0-0011◀), bit 2.</p>		

S-0-0205 - 10:1	Cooling error shut-down temperature X P-0-0915	0 to 255.0 2 bytes (dependent on power unit)
<p>If an error is determined in the cooling system (e. g. the temperature in the control cabinet is higher than the cooling error shutdown temperature), the drive sets the bit cooling error shutdown in class 1 diagnostic (▶S-0-0011◀).</p>		
S-0-0206 - 0.1 ms	Drive on delay time X P-0-1238	0 to 1000.0 2 bytes 500.0
<p>After the torque was activated (bit 14 is set in the status ▶S-0-0135◀) the drive on delay time is started. The drive follows the set values if delay time has expired.</p>		
S-0-0207 - 0.1 ms	Drive off delay time X P-0-1237	0 to 1000.0 2 bytes 500.0
<p>After „drive off“ (bit 15 in the master control word ▶S-0-0134◀) was reset and n_{\min} was reached, the delay time was started and the interlock of the brake is initiated. The torque remains activated in the drive until this drive off delay time is elapsed.</p>		
S-0-0208 - 1:1	Temperature data scaling type - (CP4) -	- to - 2 bytes 0
<p>This parameter is implemented only for compatibility reasons. The b maXX controller only supports the temperature scaling 0.1 °C.</p>		
S-0-0209 - G	Lower adaption limit X P-0-1522	0 to $+2^{31}-1$ 4 bytes 10
<p>This parameter is used for the adaption of the speed controller.</p> <p>The gain ▶S-0-0100◀) and the integral action time ▶S-0-0101◀ of the speed controller can be adapted within a set speed range.</p> <p>Below the speed „Lower adaption limit“ (▶S-0-0209◀) the values of ▶S-0-0211◀ Adaption gain and ▶S-0-0212◀ Adaption integral action time are activated. Above the „Lower adaption limit“ and below the „Upper adaption limit“ the values of the effective gain and integral action time rise linear towards the „Higher adaption limit“. The values of the „Higher adaption limit“ are the values of parameter gain (▶S-0-0100◀) and integral action time (▶S-0-0101◀) of the speed controller.</p> <p>Scaling must be considered (also see scaling ▶Speed data◀ from page 26).</p>		

S-0-0210	Upper adaption limit	0 to $+2^{31}-1$
-	X	4 bytes
G	P-0-1523	10

This parameter is used for the adaption of the speed controller.

Above the speed threshold „Higher adaption limit“ ([▶S-0-0210◀](#)) the values of gain [▶S-0-0100◀](#) and the integral action time [▶S-0-0101◀](#) of the speed controller are active.

Above the „Lower adaption limit“ and below the „Upper adaption limit“ the values of the effective gain and integral action time rise linear towards the „Higher adaption limit“. The values of the „Higher adaption limit“ are the values of parameter gain ([▶S-0-0100◀](#)) and integral action time ([▶S-0-0101◀](#)) of the speed controller.

Scaling must be considered
(also see scaling [▶Speed data◀](#) from page 26).

S-0-0211	Adaption proportional gain	1.0 to 6553.5
-	-	2 bytes
10:1	P-0-1524	100.0

This parameter sets the speed controller gain of the lower adaption limit ([▶S-0-0209◀](#)). Above the upper adaption limit the adaption gain is not effective.

The value is a percentage value of speed controller gain ([▶S-0-0100◀](#)), resolution of 0.1 %. The current effective gain is displayed in P-0-1526.

Please note example characteristics of speed controller adaption in IEC-61800-7-203[©], chapter 7.3.1.2.

S-0-0212	Adaption integral action time	1.0 to 6553.5
-	-	2 bytes
10:1	P-0-1525	100.0

This parameter sets the speed controller integral action time of the lower adaption limit ([▶S-0-0209◀](#)). Above the upper adaption limit the adaption gain is not effective.

The value is a percentage value of speed controller integral action time ([▶S-0-0101◀](#)), resolution of 0.1 %. The current effective integral action time is displayed in P-0-1527.

Please note example characteristics of speed controller adaption in IEC-61800-7-203[©], chapter 7.3.1.2.

NOTE:

The speed controller adaption must be activated in the maXX controller via P-0-1520 bit 0 = 1. The speed controller adaption is switched off by default. In addition further functions for speed controller adaption are available. For details see parameter manual b maXX 5000 or 3300 in chapter controller adaption.

S-0-0222	Spindle positioning speed	0.0572 to 29999.0848
-	X	4 bytes
10000:1	P-0-0563	91.5527

Also see [▶Command Spindle positioning◀](#) from page 56.

When the command spindle positioning ([▶S-0-0152◀](#)) was received, the drive accelerates or brakes, dependent on the present speed to the spindle positioning speed.

The parameter resolution is 0.0001 U/min.

S-0-0226	Lead spindle revolutions	1 to $2^{31} - 1$
-	X	4 bytes
-	P-0-0543	1

The speed ratio between lead spindle and synchronous spindle can be set in parameters. [▶S-0-0226◀](#) and [▶S-0-0227◀](#).

$$\text{Speed ratio} = \frac{\text{Lead spindle revolutions}}{\text{Synchronous spindle revolutions}}$$

The ratio is used in manufacturer-specific operation mode „Synchronous mode“ (operation mode code 0x8001) in order to set the ratio between leading axis and synchronous axis.

The parameter [▶S-0-0226◀](#) must be a positive integer.

S-0-0227	Synchronous spindle revolutions	-2^{31} to $2^{31} - 1$
-	X	4 bytes
-	P-0-0542	1

The revolutions of the synchronous spindle are set in this parameter.

The parameter [▶S-0-0226◀](#) must be an integer. Negative values are allowed, the value 0 is not accepted.

S-0-0254	Actual parameter set	- to -
-	-	2 bytes
-	-	0

This parameter displays the current active parameter set in the drive. The parameter set change via command 216 is not supported. Only parameter set 0 is available using SoE.

15	14	13	12	11	10	9	8	7	6	5	4	3	2	1	0	
Reserved																
													0	0	0	Parameter set 0 active

S-0-0258

CW, CR
L

Target position

x
P-0-0600

-2^{31} to $2^{31}-1$
4 bytes
0

In the operating mode „drive-internal interpolation“ or „target position setting“ the controller transmits „target position“ as set values to the drive. The drive travels to the target position, taking into account the positioning speed ([▶S-0-0259◀](#)), the positioning acceleration ([▶S-0-0260◀](#)) and the positioning jerk ([▶S-0-0193◀](#)) as permitted maximum values and the feedrate override ([▶S-0-0108◀](#)).

The travelling profile is set via P-0-0611, bit 1 and 2 (00: trapezoid, 01: S curve, further reserved).

Scaling must be considered
(also see scaling [▶Position data◀](#) from page 23).

S-0-0259

CW, CR
G

Positioning velocity

x
P-0-0602, P-0-0502

1 to $2^{31}-1$
4 bytes
0

Positioning velocity is used in the operation modes „drive internal interpolation“ and „target position setting“ as speed to travel to the „active target position“ ([▶S-0-0431◀](#)).

In operation mode manual mode the position speed sets the speed while „jogging“. The maximum speed in this operation modes is set in [▶S-0-0259◀](#) and [▶S-0-0108◀](#).

Scaling must be considered
(also see scaling [▶Speed data◀](#) from page 26).

S-0-0260

CW, CR
B

Positioning acceleration

x
P-0-0603, P-0-0503

0 to $2^{32}-1$
4 bytes
0

The position acceleration is used in operation modes „drive-internal interpolation“, target position setting and jogging as value for acceleration to positioning speed [▶S-0-0259◀](#).

The b maXX controller supports the positioning deceleration ([▶S-0-0359◀](#)). It can be set separately.

Scaling must be considered
(also see scaling [▶Acceleration and jerk data◀](#) from page 28).

S-0-0261	Coarse positioning window	0 to $2^{32}-1$
-	X	4 bytes
L	P-0-0688	0

If the difference between the position set value and the position actual value ([▶S-0-0189◀](#) position deviation) is within the „Coarse positioning window“, the drive sets the status „in position coarse“ ([▶S-0-0341◀](#)). If necessary, the status „in position coarse“ is linked to a real time status bit within the drive and transmitted to the control ([▶S-0-0305◀](#)). The status is also displayed in [▶S-0-0013◀](#) (C3D, bit 11).

$|\text{Position deviation}| < |\text{Positioning window coarse}| \Rightarrow \text{Message „In position coarse“}$

Scaling must be considered

(also see scaling [▶Position data◀](#) from page 23).

S-0-0262	Load defaults procedure command	- to -
-	-(CP3, CP4)	2 bytes
-	-	0

If the master sets and enables the command „load default values“, the default parameters (standard parameter set) are activated. Only the parameter values in the working memory (RAM) are overwritten, the stored parameter values in the flash memory remain unchanged.

The scope and contents of the default parameters (e.g. limit values, speed values etc.) are not optimized for the application. The default values provide an error-free interaction between power unit and motor.

NOTE:

Optimized parameters can be overwritten and the drive ID ([▶S-0-0341◀](#)) is deleted with the command load default values.

Following parameters remain unchanged enabling command 262: [▶S-0-0017◀](#), [▶S-0-0030◀](#), [▶S-0-0031◀](#), [▶S-0-0140◀](#), [▶S-0-0262◀](#), [▶S-0-0432◀](#), [▶S-0-0433◀](#), [▶S-0-0434◀](#).

The command is independent on the axis, i.e. the command is executed for both axes when using a double axis. The command must be started via axis 1 (drive No. 0).

Command options

Via P-0-1016 Configuration profile 1 a compatible behavior to devices type b maXX 4000 can be set. In addition to the command „Load default values“ all data sets in the flash memory are deleted automatically and parameter set 0 with default values is stored in the flash memory finally.

S-0-0263

-
-

Load working memory procedure command - to -
- (CP3, CP4) 2 bytes
- 0

When the master sets and enables the command „Load working memory“, all S parameters of the IDN list [▶S-0-0192◀](#) and all stored P parameters of the controller are loaded from the flash memory to the working memory (RAM). After switching on the controller copies automatically this data from the flash to the RAM.

In chapter „Summary of all parameters“ of the b maXX parameter manual all P parameters are marked that can be stored.

The IDN list of the storable working data ([▶S-0-0192◀](#)) enables a storage of S parameters without P parameter allocation.

The command is independent on the axis, i.e. the command is executed for both axes when using a double axis. The command must be started via axis 1 (drive No. 0).

Active parameters can be overwritten with the command 263!

Command options

Via P-0-1016 Configuration profile 1 bit 6 = 1 can be set that command 263 activates the loading of S parameters of the IDN list [▶S-0-0192◀](#) only. The loading of S parameters with P parameter allocation and P parameters is not supported in this case.

S-0-0264

-
-

Backup working memory procedure command - to -
- (CP3, CP4) 2 bytes
- 0

When the master sets and enables the command „Backup working memory“, all S parameters of the IDN list [▶S-0-0192◀](#) and all stored P parameters of the controller are written from the working memory to the non-volatile flash memory.

In chapter „Summary of all parameters“ of the b maXX parameter manual all P parameters are marked that can be stored.

The IDN list of the storable working data ([▶S-0-0192◀](#)) enables a storage of S parameters without P parameter allocation.

S parameters with P parameter allocation are stored generally with command 264 if the allocated P parameter is storable.

The command is independent on the axis, i.e. the command is executed for both axes when using a double axis. The command must be started via axis 1 (drive No. 0).

Active parameters can be overwritten with the command 264!

Command options

Via P-0-1016 Configuration profile 1 bit 6 = 1 can be set that command 264 activates the storage of S parameters of the IDN list [▶S-0-0192◀](#) only. The storing of S parameters with P parameter allocation and P parameters is not supported in this case.

S-0-0265**Language selection**

- to -
2 bytes
0

- x
-

An available language of the drive ([▶S-0-0266◀](#)) can be selected in this parameter. The text display of parameter name (element 2), unit (element 4) and diagnostic in [▶S-0-0095◀](#) is displayed in the selected language.

S-0-0266**List of available languages**

- to -
2 bytes, variable
0

-
-

This list contains the codes of the available languages.

15	14	13	12	11	10	9	8	7	6	5	4	3	2	1	0	
Reserved																
											0	0	0	0	0	German
											0	0	0	0	1	English
											Further			Reserved		

S-0-0271**Drive ID**

0 to $2^{32}-1$
4 bytes
0

- x
1:1 -

The master control can assign an unique ID for each drive. The master control can detect by comparison of this parameter value with a control-sided comparison value whether the drive was changed.

The parameter is independent of the axis, i.e. a double axis is assigned to one ID.

Note: The command „Load default values“ ([▶S-0-0262◀](#)) resets the drive ID!

S-0-0272**Velocity window percentage**

0.00 to 655.35
2 bytes
0

- x
100:1 P-0-0954, P-0-0955

If the speed control deviation is within this range the message „ $n_{\text{actual}} = n_{\text{set}}$ “ is generated by the b maXX controller (see [▶S-0-0013◀](#) bit 0 and [▶S-0-0330◀](#)). If value 0 is set, [▶S-0-0272◀](#) has no function. Further details see [▶S-0-0330◀](#).

S-0-0283	Current coordinate offset	-2 ³¹ +1 to 2 ³¹ -1
-	-	4 bytes
L	P-0-0020	0
<p>The drive displaces the position actual value to a new coordinate system with command 197 „Set coordinate system“. Parameter ▶S-0-0283◀ displays the current total displacement of the coordinate system referred to the machine reference point (= position actual value of the encoder without displacement).</p> <p>▶S-0-0283◀ is stored at the drive. The current displacement after a new start can be read by the master control and then can be changed or canceled with command 197.</p>		
S-0-0292	List of supported operation modes	- to -
-	-	2 bytes
1:1	-	*
<p>* Standard value without length definition: 0x0001, 0x0002, 0x0003, 0x0004, 0x0005, 0x0013, 0x8001, 0x8002, 0x8003, 0x8004, 0x8005, 0x8007</p> <p>In this list are set all supported operation modes of the drive. Both the Sercos operation modes and the manufacturer-specific operation modes are displayed.</p> <p>Further details see ▶Operation mode parameters◀ from page 40.</p>		
S-0-0296	Velocity feed forward gain	0.00 to 200.00
-	x	4 bytes
100:1	P-0-0047	100.00
<p>The factor is evaluated in position controlled operation modes. With the standard value of 100.00 % an operation without position deviation is possible.</p> <p>The parameter is displayed in a resolution of 0.01 %.</p> <p>With the value 0 % the velocity feed forward is switched off.</p> <p>NOTE: The difference between „without position deviation“ or „with position deviation“ is not set via bit 3 of the operation mode of the b maXX controller. Only the setting in ▶S-0-0296◀ defines the behavior.</p> <p>Further details see ▶Operation mode parameters◀ from page 40.</p> <p>The Ks scaling factor (P-0-0066; gain) must be set well adapted for an optimized effect of the precontrol. In parameter manual of the controller, chapter position/speed controller there are different procedures and calculation methods described for determination of Ks.</p>		

S-0-0300**Realtime control bit 1**

- to -

-
x
-

2 bytes

-

This parameter displays the status of the realtime control bit 1. That way it is possible to read the status of the realtime control bit 1 via the service channel. Only bit 0 is defined.

15	14	13	12	11	10	9	8	7	6	5	4	3	2	1	0
Reserved															
0 Bit reset															
1 Bit set															

S-0-0301**Allocation of realtime control bit 1**

0 to 65535

-
x
-

2 bytes

-

In order to assign a signal to the realtime control bit 1 the parameter number of the signal is written in [▶S-0-0301◀](#). After allocation the assigned signal appears in the realtime control bit 1.

Always bit 0 of the allocated IDN is used. The bit selection via S-0-0413 is not supported.

NOTE:

It is forbidden to allocate command parameters, S parameters with P parameter allocation or P parameters.

The drive generates the service channel error „Date not correct“ and the evaluation of the realtime control bit remains switched off if the IDN is not existing or the IDN is generally write-protected or is write-protected in phase 4.

S-0-0302**Realtime control bit 2**

- to -

-
x
-

2 bytes

-

This parameter displays the status of the realtime control bit 2. That way it is possible to read the status of the realtime control bit 2 via the service channel. Only bit 0 is defined.

15	14	13	12	11	10	9	8	7	6	5	4	3	2	1	0
Reserved															
0 Bit reset															
1 Bit set															

S-0-0303	Allocation of realtime control bit 2	0 to 65535
-	x	2 bytes
-	-	-

In order to assign a signal to the realtime control bit 2 the parameter number of the signal is written in [▶S-0-0303◀](#). After allocation the assigned signal appears in the realtime control bit 1.

Always bit 0 of the allocated IDN is used. The bit selection via S-0-0414 is not supported.

NOTE:

It is forbidden to allocate command parameters, S parameters with P parameter allocation or P parameters.

The drive generates the service channel error „Date not correct“ and the evaluation of the realtime control bit remains switched off if the IDN is not existing or the IDN is generally write-protected or is write-protected in phase 4.

S-0-0304	Realtime status bit 1	- to -
-	-	2 bytes
-	-	-

The parameter number for the realtime status bit 1 is defined in the Sercos status word. Therewith it is possible to read the status of the realtime status bit 1 via the service channel. Only bit 0 is defined.

15	14	13	12	11	10	9	8	7	6	5	4	3	2	1	0
Reserved															
0 Bit reset															
1 Bit set															

S-0-0305	Allocation of realtime status bit 1	0 to 65535
-	x	2 bytes
-	-	-

In order to assign a signal to the realtime status bit 1 the parameter number of the signal is written in [▶S-0-0305◀](#).

Always bit 0 of the allocated IDN is used. The bit selection via S-0-0415 is not supported.

HINWEIS:

The drive generates the service channel error „Date not correct“ and the evaluation of the realtime status bit remains switched off if the IDN is not existing or the IDN is generally write-protected or is write-protected in phase 4.

S-0-0306**Realtime status bit 2**- to -
2 bytes-
-

The parameter number for the realtime status bit 2 is defined in the Sercos status word. Therewith it is possible to read the status of the realtime status bit 2 via the service channel. Only bit 0 is defined.

15	14	13	12	11	10	9	8	7	6	5	4	3	2	1	0
----	----	----	----	----	----	---	---	---	---	---	---	---	---	---	---

Reserved

|
0 Bit reset
1 Bit set**S-0-0307****Allocation of realtime status bit 2**0 to 65535
2 bytes-
-

In order to assign a signal to the realtime status bit 2 the parameter number of the signal is written in [▶S-0-0307◀](#).

Always bit 0 of the allocated IDN is used. The bit selection via S-0-0416 is not supported.

HINWEIS:

The drive generates the service channel error „Date not correct“ and the evaluation of the realtime status bit remains switched off if the IDN is not existing or the IDN is generally write-protected or is write-protected in phase 4.

S-0-0310**Overload warning**- to -
2 bytes-
-

With this parameter a parameter number is determined for overload warning of the motor. Therewith the overload warning can be assigned to a realtime status bit (see [▶S-0-0305◀](#)). The overload warning is defined as a C2D bit ([▶S-0-0012◀](#)) and is set in dependence of the load limit of the motor ([▶S-0-0114◀](#)) accordingly. Bit 0 is defined for operation data only.

15	14	13	12	11	10	9	8	7	6	5	4	3	2	1	0
----	----	----	----	----	----	---	---	---	---	---	---	---	---	---	---

Reserved

|
0 No overload warning
1 Overload warning

S-0-0311

Amplifier overtemperature warning

- to -
2 bytes

-
-

As no amplifier temperature is detected in the b maXX controller this value is used to indicate the overload of the input stage (lxt).

If the threshold of the lxt model is reached (P-0-0922 value from power supply data) the amplifier is limited to its nominal current and the warning in parameter [▶S-0-0311◀](#) is set. The Bit is defined in C2D ([▶S-0-0012◀](#), bit 1).

15	14	13	12	11	10	9	8	7	6	5	4	3	2	1	0
----	----	----	----	----	----	---	---	---	---	---	---	---	---	---	---

Reserved

|
0 No overtemperature warning
1 Overtemperature warning

S-0-0312

Motor overtemperature warning

- to -
2 bytes

-
-

With this parameter the parameter number for the motor overtemperature warning is determined. Therewith the motor overtemperature warning can be assigned to a realtime status bit (see [▶S-0-0305◀](#)). The motor overtemperature warning is defined as C2D bit ([▶S-0-0012◀](#), bit 2) and is accordingly set depending on the motor warning temperature ([▶S-0-0201◀](#)). Bit 0 is defined for operation data only.

The current motor temperature is displayed in [▶S-0-0200◀](#) and is compared with ([▶S-0-0201◀](#)).

15	14	13	12	11	10	9	8	7	6	5	4	3	2	1	0
----	----	----	----	----	----	---	---	---	---	---	---	---	---	---	---

Reserved

|
0 No overtemperature warning
1 Overtemperature warning

S-0-0313

Cooling error warning

- to -
2 bytes

-
-

This parameter is used to define a parameter number for the cooling error warning. Therewith the cooling error warning can be assigned to a realtime status bit (see [▶S-0-0305◀](#)). The cooling error warning is defined as a C2D bit ([▶S-0-0012◀](#)) and is set in dependence of cooling error warning temperature ([▶S-0-0202◀](#)) accordingly. Bit 0 is defined for operation data only.

15	14	13	12	11	10	9	8	7	6	5	4	3	2	1	0
----	----	----	----	----	----	---	---	---	---	---	---	---	---	---	---

Reserved

|
0 No cooling warning
1 Cooling warning

S-0-0315**Positioning velocity > n_{limit}** - to -
2 bytes-
-

This function is not supported at the moment.

S-0-0323**Target position outside of travel range**- to -
2 bytes-
-

This parameter is used to define the parameter number of the warning for the „target position outside of travel range“. This allows e. g. the assigning of the warning to a realtime status bit (e. g. [▶S-0-0305◀](#)). The warning target position outside the travel range is defined as a C2D bit ([▶S-0-0012◀](#)) and is set, when the active target position ([▶S-0-0431◀](#)) is outside the position limit values (positive or negative, [▶S-0-0049◀](#), [▶S-0-0050◀](#)).

NOTE:

If the position actual value exceeds a position limit value, the bit „position limit value exceeded (shut-down)“, drive status bit 13 is set in C1D ([▶S-0-0011◀](#)).

Bit 0 is defined for operation data only.

15	14	13	12	11	10	9	8	7	6	5	4	3	2	1	0
----	----	----	----	----	----	---	---	---	---	---	---	---	---	---	---

Reserved

0 Target position within the position limits
1 Target position outside of position limits

S-0-0328**Bit No. allocation list signal statusword**- to -
2 bytes-
-

- (CP3, CP4)

*

*Standard: 0, 32, 0, 0, 0, 0, 0, 0, 0, 0, 0, 0, 0, 0, 0, 0, 0

In this configuration list the bit numbers of the programmed operation data ([▶S-0-0026◀](#)) for the signal statusword ([▶S-0-0144◀](#)) are set. The first value of [▶S-0-0328◀](#) contains the bit No. of the first parameter of the configuration list of the signal statusword ([▶S-0-0026◀](#)). This bit is mapped to bit 0 of [▶S-0-0144◀](#). The last bit No. corresponds with the last entry of [▶S-0-0026◀](#) and sets bit No. 15 of signal statusword.

Max. 16 entries can be set in [▶S-0-0328◀](#). The highest permitted bit No. is 31.

The drive reacts when changing to phase 3 (Pre-Op \Rightarrow Safe-Op) with message „Error in mapping of signal statusword“ [▶S-0-0144◀](#) in the list of command errors if the bit No. is higher than 31. The [▶S-0-0144◀](#) is entered in the IDN list of invalid operation data CP3 ([▶S-0-0022◀](#)) in this case. Further the AL status code 0x0024 for invalid actual value mapping is set in EtherCAT.

S-0-0330

Status $n_{\text{feedback}} = n_{\text{command}}$

- to -
2 bytes

-
-

This parameter is used to define a parameter No. for the status $n_{\text{actual}} \text{ value} = n_{\text{set}} \text{ value}$. This allows that the status $n_{\text{actual}} = n_{\text{set}}$ is assigned to a realtime status bit (see [▶S-0-0305◀](#)). The status $n_{\text{actual}} = n_{\text{set}}$ is defined as a C3D ([▶S-0-0013◀](#), bit 0) and is set when the speed actual value ([▶S-0-0040◀](#)) is within the programmed speed window ([▶S-0-0157◀](#) and/or [▶S-0-0272◀](#)) of the speed set value ([▶S-0-0036◀](#) and [▶S-0-0037◀](#)). Bit 0 is defined for operation data only.

Calculation of status:

$$|n_{\text{actual}} - n_{\text{set}}| \leq \text{▶S-0-0157◀} \text{ and } |n_{\text{actual}} - n_{\text{set}}| \leq |n_{\text{set}}| * \text{▶S-0-0272◀}$$

15	14	13	12	11	10	9	8	7	6	5	4	3	2	1	0
Reserved															
0															
$ n_{\text{actual}} \neq n_{\text{set}} $															
1															
$ n_{\text{actual}} = n_{\text{set}} $															

S-0-0331

Status $n_{\text{feedback}} = 0$

- to -
2 bytes

-
-

This parameter is used to define a parameter No. for the status $n_{\text{actual}} = 0$. This allows that the status $n_{\text{actual}} = 0$ is assigned to a realtime status bit (see [▶S-0-0305◀](#)). The status $n_{\text{actual}} = 0$ is defined as bit in the C3D ([▶S-0-0013◀](#), bit 1) and is set, if the speed actual value ([▶S-0-0040◀](#)) is within the standstill window ([▶S-0-0124◀](#)). Bit 0 is defined for operation data only.

15	14	13	12	11	10	9	8	7	6	5	4	3	2	1	0
Reserved															
0															
$ n_{\text{actual}} \neq 0$															
1															
$ n_{\text{actual}} = 0$															

S-0-0332

Status $n_{\text{feedback}} < n_x$

- to -
2 bytes

-
-

This parameter is used to define a parameter No. for the status $n_{\text{actual}} < n_x$. This allows the status $n_{\text{actual}} < n_x$ to be assigned to a realtime status bit ([▶S-0-0305◀](#)). The status $n_{\text{actual}} < n_x$ is defined as a C3D bit ([▶S-0-0013◀](#), bit 2) and is set if the speed actual value ([▶S-0-0040◀](#)) is less than the speed threshold n_x ([▶S-0-0125◀](#)). Bit 0 is defined for operation data only.

15	14	13	12	11	10	9	8	7	6	5	4	3	2	1	0
Reserved															
0															
$ n_{\text{actual}} \geq n_x $															
1															
$ n_{\text{actual}} < n_x $															

S-0-0333**Status $T \geq T_x$** - to -
2 bytes-
-

With this parameter a parameter number is defined for the status $T_{\text{actual}} \geq T_x$. Therewith status $T_{\text{actual}} \geq T_x$ can be assigned to a realtime status bit ([▶S-0-0305◀](#)).

Status $T_{\text{actual}} \geq T_x$ is defined as a bit in C3D ([▶S-0-0013◀](#), bit 3) and is set if the torque actual value ([▶S-0-0084◀](#)) is higher than the torque limit T_x ([▶S-0-0126◀](#)). Bit 0 is defined for operation data only.

15	14	13	12	11	10	9	8	7	6	5	4	3	2	1	0
Reserved															
0 $T_{\text{actual}} < T_x $															
1 $T_{\text{actual}} \geq T_x $															

S-0-0334**Status $T_d \geq T_{d\text{limit}}$** - to -
2 bytes-
-

With this parameter a parameter number is defined for the status $T_d \geq T_{d\text{limit}}$. Therewith status $T_d \geq T_{d\text{limit}}$ can be assigned to a realtime status bit ([▶S-0-0305◀](#)). Status $M_d \geq M_{d\text{limit}}$ is defined as a bit in C3D ([▶S-0-0013◀](#), bit 4) and is set if the torque actual value ([▶S-0-0084◀](#)) is outside the set torque limits ([▶S-0-0082◀](#), [▶S-0-0083◀](#), [▶S-0-0092◀](#)). Bit 0 is defined for operation data only.

15	14	13	12	11	10	9	8	7	6	5	4	3	2	1	0
Reserved															
0 $T_d < T_{d\text{limit}} $															
1 $T_d \geq T_{d\text{limit}} $															

S-0-0335**Status $n_{\text{command}} > n_{\text{limit}}$** - to -
2 bytes-
-

This parameter is used to define a parameter number for status $n_{\text{set}} \geq n_{\text{limit}}$. Therewith status $n_{\text{set}} \geq n_{\text{limit}}$ can be assigned to a realtime status bit ([▶S-0-0305◀](#)). The status $n_{\text{set}} \geq n_{\text{limit}}$ is defined as a bit in C3D ([▶S-0-0013◀](#), bit 5) and is set when the speed set value ([▶S-0-0036◀](#) and [▶S-0-0037◀](#)) is higher than the speed limit value ([▶S-0-0038◀](#), [▶S-0-0039◀](#), [▶S-0-0091◀](#)). Bit 0 is defined for operation data only.

15	14	13	12	11	10	9	8	7	6	5	4	3	2	1	0
Reserved															
0 $n_{\text{set}} < n_{\text{limit}} $															
1 $n_{\text{set}} \geq n_{\text{limit}} $															

S-0-0336	Status in-position	- to -
-	-	2 bytes
-	-	-

With this parameter a parameter number is defined for the status In position. Therewith the status In position is assigned to a realtime status bit ([▶S-0-0305◀](#)). The status in-position is defined as a bit in C3D ([▶S-0-0013◀](#), bit 6) and is set if the position actual value is within the position window ([▶S-0-0057◀](#)) referring to the position set value ([▶S-0-0047◀](#)). Bit 0 is defined for operation data only.

Condition:

$$|\text{Position deviation}| < \text{Position window} \Rightarrow \text{In Position}$$

15	14	13	12	11	10	9	8	7	6	5	4	3	2	1	0
Reserved															
0															
Outside of the position window															
1															
Within the position window															

S-0-0338	Position feedback = active target position	- to -
-	-	2 bytes
-	-	0

With this parameter a parameter number is defined for the status position actual value = target position. Therewith the status position actual value = target position is assigned to a realtime status bit ([▶S-0-0305◀](#)). The status position actual value = target position is defined as a bit in C3D ([▶S-0-0013◀](#), bit 8) and is set if the position actual value ([▶S-0-0051◀](#) or [▶S-0-0053◀](#)) is within the position window ([▶S-0-0057◀](#)) referring to the active position set value ([▶S-0-0431◀](#)). Bit 0 is defined for operation data only.

15	14	13	12	11	10	9	8	7	6	5	4	3	2	1	0
Reserved															
0															
Position actual value outside of the position window															
1															
▶S-0-0430◀ - position actual value < ▶S-0-0057◀															

S-0-0341**Status in coarse position**- to -
2 bytes-
-

With this parameter the parameter number for status in coarse position is defined. There-with the status in coarse position can be assigned to a realtime status bit ([▶S-0-0305◀](#)). The status „in coarse position“ is defined as bit of C3D ([▶S-0-0013◀](#), bit 11) and is set when the position actual value is within the position window ([▶S-0-0261◀](#)) relative to the position set value ([▶S-0-0047◀](#)). Bit 0 is defined for operation data only.

Condition:

$$|\text{Position deviation}| < \text{Position window coarse} \Rightarrow \text{In coarse position}$$

15	14	13	12	11	10	9	8	7	6	5	4	3	2	1	0
----	----	----	----	----	----	---	---	---	---	---	---	---	---	---	---

Reserved

0 Outside of the position window coarse
1 Within the position window coarse

S-0-0342**Status target position attained**- to -
2 bytes-
-

With this parameter a parameter number is defined for the status target position attained. Therewith the status target position attained can be assigned to a realtime status bit ([▶S-0-0305◀](#)). The status target position attained is defined as bit in C3D ([▶S-0-0013◀](#), bit 12) and is set when the position set value ([▶S-0-0047◀](#)) is equal to the active target position ([▶S-0-0431◀](#)). Bit 0 is defined for operation data only.

15	14	13	12	11	10	9	8	7	6	5	4	3	2	1	0
----	----	----	----	----	----	---	---	---	---	---	---	---	---	---	---

Reserved

0 Target position not attained
1 Target position attained
([▶S-0-0047◀](#) = [▶S-0-0430◀](#))

S-0-0346

- Positioning control word - to -
 - X 2 bytes
 - -

This parameter is used as control word for the drive-controlled positioning operation modes.

▶S-0-0346◀ is used only for the manufacturer-specific operation modes „Target position setting“ and „Jogging mode“. The Sercos positioning operation modes (operation mode, bit 4 - 7 = 0010) incl. the position set value (S-0-0282) are not supported at the moment.

Jogging mode, position controlled

Operation mode 0x8005

This operation mode is controlled via bit 1 and 2 of ▶S-0-0346◀

- 00 no movement or stop
- 01 jogging +: endless movement in positive direction
- 10 jogging -: endless movement in positive direction
- 11 stop

The other bits of ▶S-0-0346◀ are of no significance for this operation mode.

The settings for positioning profiles in ▶S-0-0259◀, ▶S-0-0260◀, ▶S-0-0359◀ and ▶S-0-0193◀ are valid.

Bit 1 of P-0-0501 Mode for S curve profile must be set if the jerk limiting (▶S-0-0193◀) is required. A „flying“ change in this operation mode is possible in an impact free way if the speed actual value synchronization is activated via P-0-0501 mode bit 0 = 1.

Position target setting

Operation mode 0x8003

The control of this operation mode is done via ▶S-0-0346◀ and ▶S-0-0393◀. The position target setting uses ▶S-0-0258◀ for target position.

The positioning start via toggle bit (bit 0) is not supported. When changing to position target setting the start bit of this operation mode (P-0-0300, bit 8) is set automatically and a new position data set is active immediately (corresponds with the behavior of ▶S-0-0346◀, bit 5 = 1). Therefore in P-0-0611 mode must be set bit 8!

While writing on ▶S-0-0346◀ via service channel bit 3 and 4 are evaluated and the P-0-0601 Target mode is set in the b maXX controller. This bits cover only a part of the possible position modes. All modes can be set directly in P-0-0601. The P-0-0601 can be changed by cyclic mapping.

Bit 1/2 of P-0-0611 mode for S curve profile must be set if the jerk limiting (▶S-0-0193◀) is required. A „flying“ change in this operation mode is possible in an impact free way if the speed actual value synchronization is activated via P-0-0611 mode bit 0 = 1.

The bits 1 to 2 and 5 to 7 of ▶S-0-0346◀ are not evaluated. The modes 000 and 010 of bits 5 to 7 correspond with the positioning functions single setpoint and set of setpoints of the controller. This positioning function are supported by the controller but realized via P parameters.

Further details see parameter manual of the controller, chapter position target setting.

15	14	13	12	11	10	9	8	7	6	5	4	3	2	1	0		
Reserved																	
																0 ⇒ 1	Transfer of the position set value with each edge of this bit
													0	0		Positioning; the positioning starts with each rising or falling edge of Bit 0	
																Termination of position by:	
													0	1		Jogging+: Endless movement towards positive direction	
													1	0		Jogging-: Endless movement towards negative direction	
													1	1		Stop with ▶S-0-0359◀	
													0			Target position of positioning is an absolute position value	
													1			Target position of positioning is an relative position value (= distance)	
																Reference point of target position of relative positioning is	
													0			last active target position (▶S-0-0431◀)	
													1			active position actual value (▶S-0-0051◀ or ▶S-0-0053◀); „flying“ positioning	
																Behavior at change of position data set	
													0			Firstly the drive moves to the active target position before it positions to the new target position	
													1			Positioning data set is changed immediately, i. e. the drive moves to the new target position immediately, bit 6 to 7 of ▶S-0-0346◀ are deactivated.	
																Behavior transition to next position data set	
													0	0		Stop at target position of active data set before moving to next target position	
													0	1		Target position of the active data set is moved towards with the speed of active data set, when reaching the target position of this start data sets the speed and acceleration of the next data set will be active.	
													1	0		Target position of the active data set is moved towards with the speed of the next data set, the acceleration and deceleration of the next data set is active immediately. The target position of the next data set is active when reaching the target position of the start data set.	
													1	1		Reserved	

S-0-0347	Velocity error	-2^{32} to $+2^{31}-1$
CR	x	4 bytes
G	P-0-0053	0
<p>The parameter displays the current deviation between speed set value and speed actual value at the speed controller input.</p>		
S-0-0348	Acceleration feed forward gain	0.00 to 200.00
-	x	4 bytes
100:1	P-0-0062, P-0-0063	100.00
<p>The feed forward gain is active in all operation modes with active speed controller. The standard value of 100.00 % reduces the position deviation (▶S-0-0189◀) and the velocity error (▶S-0-0347◀).</p> <p>Resolution of this parameter 0.01 %. Value 0 % switches off the feed forward gain.</p>		
<p>NOTE:</p> <p>The acceleration feed forward gain is always active. The difference between „without position deviation“ or „with position deviation“ is not set via bit 3 of the operation mode of the b maXX controller. This is also valid for the speed feed forward ▶S-0-0296◀. Further details see ▶Operation mode parameters◀ from page 40.</p> <p>The Ks scaling factor (P-0-0066; gain) must be set well adapted for an optimized effect of the precontrol. In parameter manual of the controller, chapter position/speed controller there are different procedures and calculation methods described for determination of Ks.</p>		
S-0-0359	Positioning deceleration	0 to $+2^{31}-1$
CW, CR	x	4 bytes
B	P-0-0604, P-0-0504	0
<p>With the positioning deceleration the positioning speed (▶S-0-0259◀) is reduced in the operating modes „interpolation“ and „position target setting“.</p> <p>Scaling must be considered (also see scaling ▶Acceleration and jerk data◀ from page 28).</p>		

S-0-0372CR
B**Drive halt acceleration bipolar**x
P-0-06771 to $+2^{31}-1$
4 bytes
200

This parameter determines the max. deceleration when stopping the drive.

If the bit „Halt drive“ is set in the master control word ([▶S-0-0134◀](#), bit 13) this parameter is set for maximum deceleration in following operation modes:

- Position control (operation modes 0x0003, 0x0004, 0x0005)
- Drive-controlled homing (operation mode 0x8007)

The parameter is also set as deceleration if the monitoring of the hardware or software limit switches a stop initiates in following operation modes:

- Position control (operation mode 0x0003, 0x0004, 0x0005)
- Position target setting (operation mode 0x8003)
- Manual mode (operation mode 0x8005)

Scaling must be considered

(also see scaling [▶Acceleration and jerk data◀](#) from page 28)!

NOTE:

Details concerning „Halt drive“ via master control word see [▶S-0-0134◀](#).

S-0-0373-
-**Service channel error list**-
-- to -
4 bytes, variable
0.80

With every service channel error the drive stores the parameter number and the error code in this list. The list is organized as a ring buffer. When the list is read via the service channel the last error recorded is positioned as the first element of the list.

Max. 20 errors can be stored and displayed.

The display format of the list elements is hexadecimal.

Bits 31-16: Error code (Sercos)

Bits 15-0: Parameter No., at which this error has occurred.

Example:

[▶S-0-0373◀](#)[0] = 7007 0167_{hex}

⇒ Error code 0x7007 „Data > max. input value“

⇒ 0x0167 = IDN [▶S-0-0359◀](#)

The error codes of the service channel are listed in Service channel, data status.

The warning 1521 „Warning - Error reading service data“ or 1522 „Warning - Error writing service data“ is set additionally in case of a service channel error.

This can be recognized in parameters diagnostics ([▶S-0-0095◀](#)), in C2D ([▶S-0-0012◀](#), bit 15), in manufacturer class 2 diagnostic ([▶S-0-0181◀](#)) and in diagnostic No. ([▶S-0-0390◀](#)).

S-0-0374	Procedure command error list	- to -
-	-	4 bytes, variable
-	-	0.80

With every command error the drive stores the parameter number and a manufacturer-specific error code in this list. The list is organized as a ring buffer. When the list is read via the service channel the last error recorded will be positioned as the first element of the list.

Max. 20 errors can be stored and displayed.

The display format of the list elements is hexadecimal.

In addition a diagnostic message is generated in [▶S-0-0095◀](#).

Bits of [▶S-0-0374◀](#):

Bit 31 to 16: Error code (manufacturer-specific definition)

Bit 15 to 0: Parameter No. of the command, which causes the error

Example 1:

[▶S-0-0374◀](#)[0] = 000F 0094_{hex}

⇒ Error code 0x000F ⇒ „General command error“

⇒ 0094 hex = IDN [▶S-0-0148◀](#)

[▶S-0-0095◀](#) = „Error: Command IDN-0148 cannot be executed“

Example 2:

[▶S-0-0374◀](#)[1] = 0600 007F_{hex}

⇒ Error code 0x0600

⇒ Error 1536

„Value control unit cycle time ([▶S-0-0001◀](#)) invalid“

⇒ 007F hex = IDN [▶S-0-0127◀](#)

[▶S-0-0095◀](#) = „Error: Command IDN-0127: Phase transition to CP3 not possible“

In addition a message with the status is send to the master via the mailbox and the corresponding AL status code is set when using EtherCAT.

S-0-0375**Diagnostic numbers list**

- to -
4 bytes, variable
0.8

The drive saves each change of the diagnostic numbers in this list. The list is organized as a ring buffer. When the list is read via the service channel the last error recorded will be positioned as the first element of the list.

Max. 20 messages can be stored and displayed.

The display format of the list elements is hexadecimal.

In addition the message of parameter diagnostic ([▶S-0-0095◀](#)) is displayed as a text message. In case it is an error message, the diagnostic number ([▶S-0-0390◀](#)), the C1D ([▶S-0-0011◀](#)) and if applicable the manufacturer class 1 diagnostic ([▶S-0-0129◀](#)) is set.

The message phase change can be switched on or off for [▶S-0-0095◀](#) via configuration profile 1 (P-0-1016 bit 0). See also chapter 5.4 Configuration parameters of the controller.

Bits of [▶S-0-0375◀](#):

Bit No.	Meaning
0 to 14	Phase No. at time of message (phase definition according Sercos)
15	0: Message (e.g. message at phase transition) 1: Error
16 to 31	Diagnostic code (manufacturer-specific definition)

NOTE:

The error codes of group 1500 (1500 to 1599) apply to the fieldbus and are described in this handbook in [▶Error Handling◀](#) from page 149. All other error codes are described in parameter manuals of b maXX 5000 or b maXX 3300.

Example 1:

[▶S-0-0375◀](#)[0] = 0190 8003_{hex}
 ⇒ Error code 0x0190
 ⇒ Error 400 „Amplitude of encoder signal too low“
 ⇒ 0x8003 ⇒ Error in phase 3 (Safe-Op) set

[▶S-0-0095◀](#) = „E0400: Error drive | Amplitude of encoder signal too low“

[▶S-0-0390◀](#) = 0x0000190 = 400

Example 2:

[▶S-0-0375◀](#)[0] = 00041 00004_{hex}
 ⇒ Message 0x0041 hex ⇒ „Change from phase 3 to 4 finished“
 ⇒ 0x0004 ⇒ Message phase 4 (operational) set

[▶S-0-0095◀](#) = „Communication phase 4 ready“

Diagnostic codes for messages at phase transition:

Diagnostic code	Message
0x0001	Phase 0 active
0x0010	Transition of phase 0 ⇒ 1 started
0x0011	Transition of phase 0 ⇒ 1 ended; phase 1 active
0x0012	Intermediate state when changing phase 0 ⇒ 1
0x0020	Transition of phase 1 ⇒ 2 started
0x0021	Transition of phase 1 ⇒ 2 ended; phase 2 (Pre-Operational) active
0x0030	Transition of phase 2 ⇒ 3 started; command 127
0x0031	Transition of phase 2 ⇒ 3 ended; phase 3 (Safe-Op) active
0x0041	Transition of phase 3 ⇒ 4 ended; phase 4 (Operational) active
0x0CB0	Switch back to phase 0
0x0CB2	Switch back to phase 2 (Pre-Op)
0x0CB3	Switch back to phase 3 (Safe-Op)

S-0-0376

-
-

Baud rate

-
-

- to -
2 bytes
0x010F

The controller places the supported transmission rates in this parameter.

15	14	13	12	11	10	9	8	7	6	5	4	3	2	1	0
Reserved								Reserved							
								1 1 - 2 Mbit/s available							
								0 0 - 4 Mbit/s not available							
								1 1 - 4 Mbit/s available							
								0 0 - 8 Mbit/s not available							
								1 1 - 8 Mbit/s available							
								0 0 - 16 Mbit/s not available							
								1 1 - 16 Mbit/s available							
								0 Automatic baud rate recognition is not supported							
								1 Automatic baud rate recognition is supported							

S-0-0378	Absolute encoder range 1	0 to $2^{32} - 1$
-	- (CP3, CP4)	4 Bytes
L	P-0-0951	0
<p>If the motor encoder is an absolute measuring system, this parameter displays the absolute encoder range in position scaling respectively this value can be set.</p> <p>This value is calculated automatically at initialization in consideration of gear factor (▶S-0-0121◀, ▶S-0-0122◀) and feed constant (▶S-0-0123◀) or rotational position resolution (▶S-0-0079◀) for encoders with EnDat[®] or Hiperface[®] interface.</p> <p>For encoders without electronic type plate (e.g. SSI absolute value encoders) the parameter value must be calculated and set. After changing the new value must be stored in the parameter set and the encoder must be re-initialized (e.g. via a restart of the device).</p> <p>If the absolute encoder range is higher than the 32 bit number range in the set position resolution, the value is limited to the maximum value of $2^{32} - 1$.</p> <p>Scaling must be considered (also see scaling ▶Position data◀ from page 23)!</p>		
S-0-0379	Absolute encoder range 2	0 to $2^{32} - 1$
-	- (CP3, CP4)	4 Bytes
L	-	0
<p>If the external, optional encoder is an absolute measuring system, this parameter displays the absolute encoder range in position scaling respectively this value can be set.</p> <p>Description see ▶S-0-0378◀.</p> <p>Scaling must be considered (also see scaling ▶Position data◀ from page 23)!</p>		
S-0-0380	DC bus voltage	10 to 1000
CR	-	2 bytes
1:1	P-0-0932	10
<p>This parameter displays the current DC link voltage (DC bus voltage), resolution of 1 V.</p>		
S-0-0383	Motor temperature	0.0 to 300.0
-	-	2 bytes
10:1	P-0-0822	0
<p>Display of the current measured motor temperature, resolution of 0.1 °C.</p>		
S-0-0384	Amplifier temperature	0.0 to 1000.0
-	-	2 bytes
10:1	P-0-0930	0
<p>Display of the current measured temperature within the power unit, resolution of 0.1 °C.</p>		

S-0-0385	Active power	- 1000000 to 1000000
CR	-	4 Bytes
1:1	P-0-0031	0

Display of the current active power of the motor in W.

S-0-0389	Effective current	0 to 10000.000
-	-	4 bytes
1000:1	P-0-0030	10

Display of the amount of the motor actual current effective on base of the filtered actual values from d and q current. Parameter resolution of 0.001 A.

The parameter is updated in a 2 ms cycle. The filter time constant for d and q current is 1 ms.

$$\triangleright \text{S-0-0389} \triangleleft = \text{sqrt} (I_d^2 + I_q^2)$$

S-0-0390	Diagnostic numbers	0 to $2^{32}-1$
-	-	4 bytes
1:1	-	0

This parameter displays the code of diagnostic message as hexadecimal value.

Only error codes are displayed at the moment. The optional output of phase transitions, according [▷S-0-0375◀](#) is not possible.

The error codes of group 1500 (1500_{dez} to 1599_{dez}) concern the fieldbus and are described in this handbook in [▷Error Handling◀](#) from page 149. All other error codes are described in parameter manual of b maXX 2500, 3300 or 5000.

S-0-0392	Velocity feedback filter	0 to 50000
-	x	2 bytes
1:1	P-0-0057	0

The time constant of the speed actual value filter (PT1) in μs is set in this parameter. A value of 0 μs switches off the filter.

S-0-0393	Command value mode	- to -
-	x	2 bytes
-	-	0

If the function is active the interpretation of position set values is dependent upon the set-point setting. This command is active only in operation modes „drive-internal interpolation“ and „position target setting“.

15	14	13	12	11	10	9	8	7	6	5	4	3	2	1	0
Reserved															Speed direction
													0	0	Clockwise, positive direction
													0	1	Counterclockwise, negative direction
													1	0	Shortest path
													1	1	Reserved

S-0-0400**Home switch**

- to -
2 bytes
0

This parameter is used to assign a parameter number with the home switch (external signal). Therewith the home switch can be assigned to a realtime status bit ([▶S-0-0305◀](#)).

At active command „control unit controlled homing“ ([▶S-0-0146◀](#)) the home switch only is valid if homing enable ([▶S-0-0146◀](#)) is set. Bit 0 is defined for operation data only.

15	14	13	12	11	10	9	8	7	6	5	4	3	2	1	0
Reserved															
0 Inactive switch															
1 Switch active															

S-0-0401**Probe 1**

- to -
2 bytes
0

With this parameter a parameter number is assigned to probe 1 (external signal). Therewith probe 1 can be assigned to a realtime status bit ([▶S-0-0305◀](#)). Additional parameters are [▶S-0-0130◀](#) and [▶S-0-0131◀](#).

The signal probe 1 is checked and updated by the drive only, if the command probe cycle ([▶S-0-0170◀](#)) is active and the signal probe 1 enable ([▶S-0-0405◀](#)) is set. Bit 0 is defined for operation data only.

15	14	13	12	11	10	9	8	7	6	5	4	3	2	1	0
Reserved															
0 Probe inactive															
1 Probe active															

S-0-0402**Probe 2**

- to -
2 bytes
0

With this parameter a parameter number is assigned to probe 2 (external signal). Therewith probe 2 can be assigned to a realtime status bit ([▶S-0-0305◀](#)). Additional parameters are [▶S-0-0130◀](#) and [▶S-0-0131◀](#).

The signal probe 2 is checked and updated by the drive only, if the command probe cycle ([▶S-0-0170◀](#)) is active and the signal probe 2 enable ([▶S-0-0406◀](#)) is set. Bit 0 is defined for operation data only.

15	14	13	12	11	10	9	8	7	6	5	4	3	2	1	0
Reserved															
0 Probe inactive															
1 Probe active															

S-0-0403

Position feedback value status

- to -
2 bytes
0

When the drive switches the position actual values to the coordinates referred to the machine zero point the bit 0 is set in this parameter. Therewith the master control is informed, that the drive refers all position actual values to the zero point of the machine starting from this point of time.

Bit 0 is reset when either the commands „displacement in homing system“ ([▶S-0-0172◀](#)) or „drive controlled homing“ ([▶S-0-0148◀](#)) is started or when the drive has lost its reference to the zero point of the machine. The status position actual value can be assigned to a realtime status bit ([▶S-0-0305◀](#)) and therewith it can permanently signaled to the master control using the drive status. Bit 0 is defined for operation data only.

Bit 0 is also assigned to C3D, bit 14.

15	14	13	12	11	10	9	8	7	6	5	4	3	2	1	0
Reserved															

- |
- 0 Position actual values are not referred to the zero point of the machine
 - 1 Position actual values are referred to the zero point of the machine

S-0-0404

Position reference value status

- to -
2 bytes
0

When the position set values are switched to the coordinates referred to the machine zero point the bit 0 is set from the drive in this parameter. Therewith the control is informed, that the drive refers all position set values to the zero point of the machine starting from this point of time. At the same time the master control inputs the new position set values in the cyclical data.

Bit 0 is reset, if the command „displacement in reference system“ ([▶S-0-0172◀](#)) is activated. The status position set values can be assigned to a realtime control bit ([▶S-0-0301◀](#)) and therefore it can permanently signaled to the master control using the drive status. Bit 0 is defined for operation data only.

15	14	13	12	11	10	9	8	7	6	5	4	3	2	1	0
Reserved															

- |
- 0 Position set values are not referred to the zero point of the machine
 - 1 Position set values are referred to the zero point of the machine

S-0-0405

CW

-

Probe 1 enable

x

-

- to -

2 bytes

0

With this parameter a parameter number is assigned to the probe 1 enable. Therewith a realtime control bit ([▶S-0-0301◀](#)) can be assigned to the probe 1 enable.

Probe 1 enable is checked by the drive only as long as the command probe cycle ([▶S-0-0170◀](#)) is active. For a new probe cycle with the same edge of probe 1 the control has to reset probe 1 enable to „0“ and set it to „1“. Bit 0 is defined for operation data only.

Further details see [▶S-0-0179◀](#)

15	14	13	12	11	10	9	8	7	6	5	4	3	2	1	0
Reserved															
0 Probe 1 not enabled															
1 Probe 1 enabled															

S-0-0406

CW

-

Probe 2 enable

x

-

- to -

2 bytes

0

With this parameter a parameter number is assigned to the probe 2 enable. Therewith a realtime control bit ([▶S-0-0301◀](#)) can be assigned to the probe 2 enable.

Probe 2 enable is checked by the drive only as long as the command probe cycle ([▶S-0-0170◀](#)) is active. For a new probe cycle with the same edge of probe 2 the control has to reset probe 2 enable to „0“ and set it to „1“. Bit 0 is defined for operation data only.

15	14	13	12	11	10	9	8	7	6	5	4	3	2	1	0
Reserved															
0 Probe 2 not enabled															
1 Probe 2 enabled															

S-0-0407

-

-

Homing enable

x

-

- to -

2 bytes

0

This parameter is used to assign a parameter number to homing enable. This allows the status homing enable to be assigned to a realtime control bit ([▶S-0-0301◀](#)).

The drive evaluates the homing enable only while the command „Control unit controlled homing“ ([▶S-0-0146◀](#)) is active. Bit 0 is defined for operation data only.

15	14	13	12	11	10	9	8	7	6	5	4	3	2	1	0
Reserved															
0 Homing disable															
1 Homing enabled															

S-0-0408	Reference marker pulse registered	- to -
-	-	2 bytes
-	-	0

The parameter is used to latch a parameter number to a reference marker. This allows the reference marker registered to be assigned to a realtime status bit ([▶S-0-0305◀](#)).

The drive sets this bit to „1“ if the command „Control unit controlled homing“ ([▶S-0-0146◀](#)) is active, if the homing is enabled ([▶S-0-0407◀](#)) and the marker pulse of the encoder system (external signal) is registered.

Simultaneously the drive stores the referenced position actual value into the according marker position ([▶S-0-0173◀](#)). The drive resets this bit to „0“, if the control activates the command „Control unit controlled homing“. The „reference marker registered“ is only valid as long as the command „Control unit controlled homing“ is active. This bit is not changed by the command „drive-controlled homing“ ([▶S-0-0148◀](#)). Bit 0 is defined for operation data only.

15	14	13	12	11	10	9	8	7	6	5	4	3	2	1	0
Reserved															
0 Reference marker not registered															
1 Reference marker registered															

S-0-0409	Probe 1 positive latched	- to -
-	-	2 bytes
-	-	0

This parameter is used to assign a parameter number to probe 1 positive latched. This allows the status „probe 1 positive latched“ to be assigned to a realtime status ([▶S-0-0305◀](#)).

The bit 0 in this parameter is only set by the drive when the command probe cycle ([▶S-0-0170◀](#)) is active, if the signal probe 1 enable ([▶S-0-0405◀](#)) is set to „1“ and the positive edge of probe 1 ([▶S-0-0401◀](#)) is registered. Simultaneously the drive stores the position actual value into probe 1 positive ([▶S-0-0130◀](#)).

The drive resets this bit, if the control resets the command probe cycle or sets the probe 1 enable to „0“ (also see [▶S-0-0179◀](#)).

15	14	13	12	11	10	9	8	7	6	5	4	3	2	1	0
Reserved															
0 Probe value 1 positive not latched															
1 Probe value 1 positive latched															

S-0-0410**Probe 1 negative latched**

- to -
2 bytes
0

This parameter is used to latch a parameter number with probe value 1 negative. This allows the status „probe 1 negative latched“ to be assigned a realtime status bit ([▶S-0-0305◀](#)).

Bit 0 of this parameter is set by the drive only if the procedure command „probe cycle“ ([▶S-0-0170◀](#)) is active, the signal „probe 1 enable“ ([▶S-0-0405◀](#)) is set to 1 and the negative edge of probe 1 ([▶S-0-0401◀](#)) is registered. Simultaneously the drive stores the position actual value into the probe 1 negative ([▶S-0-0131◀](#)).

The drive resets this bit, if the control resets the command probe cycle or sets the probe 1 enable to „0“ (also see [▶S-0-0179◀](#)).

15	14	13	12	11	10	9	8	7	6	5	4	3	2	1	0
Reserved															
														0	Probe value 1 negative not latched
														1	Probe value 1 negative latched

S-0-0411**Probe 2 positive latched**

- to -
2 bytes
0

This parameter is used to assign a parameter number to probe 2 positive latched. This allows the status „probe 2 positive latched“ to be assigned to a realtime status ([▶S-0-0305◀](#)).

The bit 0 in this parameter is only set by the drive when the command probe cycle ([▶S-0-0170◀](#)) is active, if the signal probe 2 enable ([▶S-0-0406◀](#)) is set to „1“ and the positive edge of probe 2 ([▶S-0-0402◀](#)) is registered. Simultaneously the drive stores the position actual value into probe 2 positive ([▶S-0-0132◀](#)).

The drive resets this bit, if the control resets the command probe cycle or sets the probe 2 enable to „0“ (also see [▶S-0-0179◀](#)).

15	14	13	12	11	10	9	8	7	6	5	4	3	2	1	0
Reserved															
														0	Probe value 2 positive not latched
														1	Probe value 2 positive latched

S-0-0412

Probe 2 negative latched

- to -
2 bytes
0

This parameter is used to assign a parameter number with probe value 2 negative. This allows the status „probe 2 negative latched“ to be assigned a realtime status bit ([▶S-0-0305◀](#)).

Bit 0 of this parameter is set by the drive only, if the procedure command „probe cycle“ ([▶S-0-0170◀](#)) is active, the signal probe 2 enable' ([▶S-0-0406◀](#)) is set to 1 and the negative edge of probe 2 ([▶S-0-0402◀](#)) is registered. Simultaneously the drive stores the position actual value into the probe 2 negative ([▶S-0-0133◀](#)).

The drive resets this bit, if the control resets the command probe cycle or sets the probe 2 enable to „0“ (also see [▶S-0-0179◀](#)).

15	14	13	12	11	10	9	8	7	6	5	4	3	2	1	0
Reserved															
0															
Probe 2 negative not latched															
1															
Probe 2 negative latched															

S-0-0419

Positioning acknowledge

- to -
2 bytes
0

This parameter is used to acknowledge the transfer of the new target position ([▶S-0-0258◀](#)) in operation mode „Target position setting“. Simultaneously with the acknowledgment the new value is displayed in [▶S-0-0430◀](#) Active target position.

Further details see [▶S-0-0346◀](#) Control word positioning:

15	14	13	12	11	10	9	8	7	6	5	4	3	2	1	0
Reserved															
0 ⇒ 1															
Positioning set value acknowledged															
1 ⇒ 0															
Positioning set value acknowledged															

S-0-0429

Emergency Stop deceleration

0 to $+2^{31} - 1$
4 Bytes
0

-
B

X
P-0-0337

This parameter sets the maximum deceleration of the drive in case of „Drive OFF“, „Disable drive“ or error reaction quick stop.

The drive can be stopped by the master control via master control word ([▶S-0-0134◀](#) bit 15 and bit 14). The table shows the necessary settings of the P parameters for the control commands via bit 14 and 15 respectively the settings for the error case to enable the Emergency Stop deceleration.

Master control word ([▶S-0-0134◀](#))

Bit 15	Bit 14	Meaning	Controller parameter
1 ⇒ 0	1	Drive OFF	P-0-0311 SHUT-DOWN reaction = 2
1 ⇒ 1/0	1 ⇒ 0	Drive disabled	P-0-0312 DISABLE reaction = 2
1	1	Error message fieldbus controller	P-0-0310 QUICK STOP reaction = 2

The error reaction can be set for each controller error separately. For details see parameter manual of the b maXX controller, chapter error management. For all errors with set error reaction of „Brake at quickstop ramp“ the Emergency Stop deceleration is active.

The reaction of errors generated by the fieldbus controller (error group 1500) must be set in P-0-0310 to QUICKSTOP reaction. Setting P-0-0310 =2 enables the Emergency Stop deceleration.

Scaling must be considered

(also see scaling [▶Acceleration and jerk data◀](#) from page 28).

S-0-0430

CR
L

Active target position

-
P-0-0568

-2^{31} to $+2^{31}-1$

4 bytes

-

In the operation mode „drive-internal interpolation“ and „position target setting“ the drive writes the target position ([▶S-0-0258◀](#)) into the active target position. The actual target position is only a buffer memory in the drive and therefore cannot be configured in the MDT and can only be read via the service channel.

Scaling must be considered

(also see scaling [▶Position data◀](#) from page 23).

S-0-0431

-
B

Spindle positioning acceleration bipolar

-
P-0-0564

1 to $+2^{31}-1$

4 bytes

200

If the command „Spindle positioning“ ([▶S-0-0152◀](#)) is received by the drive, the drive accelerates or decelerates with the value of [▶S-0-0431◀](#) to the spindle positioning speed ([▶S-0-0222◀](#)).

Scaling must be considered

(also see scaling [▶Acceleration and jerk data◀](#) from page 28).

S-0-0432

-
-

Serial number drive controller

-
-

- to -

2 bytes, variable

0

This parameter displays the serial No. of the drive controller. The parameter is set when switching on the device only. The command „Load default values“ ([▶S-0-0262◀](#)) has no influence to the display.

S-0-0433	Serial number power stage	- to - 2 bytes, variable 0
-	-	
-	-	
	This parameter displays the serial No. of the power unit as text. The parameter is set when switching on the device only. The command „Load default values“ (▶S-0-0262◀) has no influence to the display.	
S-0-0434	Serial number motor	- to - 2 bytes, variable 0
-	-	
-	-	
	This parameter displays the serial No. of the motor as text. The parameter is set when switching on the device only. The command „Load default values“ (▶S-0-0262◀) has no influence to the display.	
S-0-0435	Operating time drive control	0 to 1193046 h 4 bytes 0 h
-	-	
1:1	P-0-0001	
	This parameter displays the operating time drive control in hours. If a higher resolution is requested, the operating time is displayed in P-0-0001 in seconds.	
S-0-0436	Operating time power stage	0 to 1193046 h 4 bytes 0 h
-	-	
1:1	P-0-0948	
	This parameter displays the operating time power stage with drive enable (IGBT pulsed) in hours. If a higher resolution is requested, the operating time is displayed in P-0-0948 in seconds.	
S-0-0437	Positioning status	- to - 2 bytes 0
-	-	
-	-	
	This function is not supported at the moment!	
S-0-0438	Vendor name	- to - 2 bytes, variable *
-	-	
-	-	
	This parameter shows the manufacturer name of the device. In this case „Baumueller Nuernberg GmbH“.	
S-0-0439	Vendor ID	- to - 4 bytes 346
-	-	
-	-	
	This parameter shows the manufacturer code of the device. The manufacturer code is assigned by EtherCAT Technology Group.	

ERROR HANDLING

It must be differed between errors in the fieldbus controller and errors in the drive controller when handling errors.

9.1 Errors of the fieldbus controller

9.1.1 Fatal errors

Fatal errors of the fieldbus controller result in a not functioning fieldbus connection. A return from this state is only possible by switching off/on.

9.1.2 Configuration errors

The second error category, causing the controller cannot start operation. These errors occur, when the basic communication operates via the fieldbus. For signaling these errors the fieldbus is used (C1D, C2D, C3D and [▶S-0-0014◀](#)).

9.2 Errors of the drive controller

Error detected by the controller are signalized to the fieldbus. As long as the errors cannot be displayed on standard errors, -warnings or -messages, they are transmitted as manufacturer-specific errors, warnings or messages.

The drive controller errors are also visualized at the device on the 7-segment display of the device.

9.3 Error parameters

- S-0-0011** **Class 1 diagnostic**
The recognition of fatal errors leads to the best possible shutdown of the drive.
The bit 13 (class 1 diagnostic) is set in the status word.
Also see chapter parameter [▶S-0-0011◀](#) on [▶page 62◀](#).
- S-0-0012** **Class 2 diagnostic**
Shutdown pre-warning, bit for class 2 diagnostic (bit 12) is set in the status word.
Also see chapter parameter [▶S-0-0012◀](#) on [▶page 63◀](#).
- S-0-0013** **Class 3 diagnostic**
Drive operation status flags. When a condition changes in the drive, the corresponding bit changes in the C3D, this sets the change bit for C3D in the drive status (bit 11) to a binary „1“.
Also see chapter parameter [▶S-0-0013◀](#) on [▶page 64◀](#).
- S-0-0014** **Interface status**
If a communication error has occurred, bit 12 in the parameter C1D ([▶S-0-0011◀](#)) is set. The drive resets a communication error only if the error at the interface has been eliminated and if receiving the command „reset class 1 diagnostic“ ([▶S-0-0099◀](#)) via the service channel (also see chapter parameter description on [▶page 59◀](#)).
No AL status code is additionally messaged via the [▶S-0-0014◀](#) with exception of the both communication errors „Synchronization lost“ (error code 1525) and „Timeout watchdog process data“ (error code 1526). This error type is only generated by the slave or acknowledged by the master via the registers of the EtherCAT state machine (AL control, AL status, AL status code).
- S-0-0129** **Manufacturer class 1 diagnostic**
This parameter contains the b maXX controller error code (see parameter manual b maXX and parameter manufacturer class 1 diagnostic). In [▶S-0-0129◀](#) only the first detected error code of the drive controller is displayed.
An error of group 1500_{dez} generates always its error code in the controller, too. Therefore an error of the fieldbus controller is also displayed in ProDrive and can be seen by flashing error LED (H14). Bit 16 of parameter P-0-1200 Mode error display must be set if the code of the error type are to be shown at the display.
- S-0-0181** **Manufacturer class 2 diagnostic**
This parameter contains the warning codes of the b maXX controller. The error messages are described in the parameter manual of the controller b maXX 2500, 3300 and 5000. Error codes of error group 1500_{dec} are generated by the fieldbus controller and described in the following.

9.4 Error and warning messages of the fieldbus controller

Error No. dec	Error No. hex	Error text	Error description
1500	0x05DC	Fieldbus software has a critical error	A critical error has occurred and the fieldbus software is not functioning anymore. The error is generated if no EtherCAT FPGA firmware is loaded in the device. The existing firmware type is displayed in parameter 131.22 fieldbus type (P-0-1019).
1501	0x05DD	No response from the slave (HPI buffer initialization)	No response from the slave within a defined period.
1502	0x05DE	Message length is greater than HPI buffer	
1503	0x05DF	Access to HPI wrong channel	Access to a wrong (not existing) HPI channel
1504	0x05E0	Channel was not initialized	First access to the HPI channel was earlier than the initialization.
1505	0x05E1	HPI buffer is empty	HPI buffer contains no available user data
1506	0x05E2	HPI buffer is full	HPI buffer contains available user data or former telegram was not retrieved.
1507	0x05E3	TCP IP stack could not be initialized	Error when initializing the TCP/IP stacks
1508	0x05E4	SoE firmware error message	Error of SoE firmware (Servo drive profile over EtherCAT) signaled to the controller. The error reaction is triggered by the SoE firmware within the fieldbus processor.
1509	0x05E5	EtherCAT IP core cannot init EEPROM	
1510	0x05E6	Sub device index invalid	Sub device index invalid, i. e. out of range
1511	0x05E7	Firmware error fieldbus controller	Fieldbus controller signaled a firmware error.
1512	0x05E8	Faulty backup of operation data	
1513	0x05E9	Illegal drive address	A invalid drive address is set.
1514	0x05EA	Error caused by memory allocation	
1515	0x05EB	Faulty task start	Operating system was not able to start a task.
1516	0x05EC	Faulty init of scaling data	
1517	0x05ED	Error during reading of the cyclic actual values	
1518	0x05EE	Error during writing of the cyclic set values	
1519	0x05EF	Critical GDP error while initialization	Incorrect reading or writing of important data via GDP. GDP means the communication between controller and fieldbus controller.
1520	0x05F0	Invalid version of the controller firmware	Installed controller firmware cannot be used with this type of fieldbus. Version see controller parameter P102.2 or IDN P-0-0221
1521	0x05F1	Warning: Error while reading service data	
1522	0x05F2	Warning: Error while writing service data	
1523	0x05F3	Error during command execution	An error occurred during a command execution.
1524	0x05F4	Timeout during command execution	A timeout occurred during a command execution.
1525	0x05F5	MST-Error; drive controller lost synchronization	Sercos: MST incorrect SoE: controller signaled lost synchronization
1526	0x05F6	Error: MDT miss twice; watchdog timeout process data	Sercos: failure of MDT (MDT miss twice) SoE: watchdog timeout at process data
1527	0x05F7	Error during switch up of phase	Error during switch up of the bus state (phase switch up)

9.4 Error and warning messages of the fieldbus controller

Error No. dec	Error No. hex	Error text	Error description
1528	0x05F8	Error during switch down of phase	Error during switch down of the bus state (phase switch down)
1529	0x05F9	Phase transition without ready acknowledge	Sercos: <ul style="list-style-type: none"> ○ switch up to CP3 not possible ⇒ back to CP0. ○ switch up to CP4 not possible ⇒ back to CP0. SoE: <ul style="list-style-type: none"> ○ switch up to Safe-Op not possible ⇒ back to Pre-OP. ○ switch up to Op not possible ⇒ back to Safe-OP.
1530	0x05FA	Error: Invalid phase	Invalid phase (bus state) set.
1531	0x05FB	Switch to non-initialized operation mode	Switch to a not supported or unknown operation mode.
1532	0x05FC	Error: Two drives with same address in ring	Error message only possible using Sercos.
1533	0x05FD	Error while reading sync data of drive controller	Error when adjusting the synchronization data with the settings in the drive controller.
1534	0x05FE	Overflow mailbox service	Overflow during a fragmented mailbox service.
1535	0x05FF	Invalid mailbox size	Error detected when checking the mailbox size.
1536	0x0600	Invalid controller unit cycle time ▷S-0-0001◀	Invalid value of the NC cycle time (▷S-0-0001◀), because a) NC cycle time is not a multiple of ▷S-0-0002◀ communication cycle time b) NC cycle time cannot be written to the allocated controller parameter c) GDP problem during reading of relevant controller parameters ⇒ Change to phase 3 (Safe-Op) has been aborted.
1537	0x0601	Invalid telegram type ▷S-0-0015◀	Not implemented telegram type set in ▷S-0-0015◀ ⇒ Change to phase 3 (Safe-Op) has been aborted.
1538	0x0602	Invalid IDN in config. list AT ▷S-0-0016◀	Invalid IDN set in config. list AT, see ▷S-0-0187◀ . ⇒ Change to phase 3 (Safe-Op) has been aborted.
1539	0x0603	Length of config. data in AT exceeded; see ▷S-0-0185◀	Permitted length see ▷S-0-0185◀ . ⇒ Change to phase 3 (Safe-Op) has been aborted.
1540	0x0604	Number of cycle actual values exceeded limit (mapping drive controller ⇔ fieldbus controller)	Permitted number of 16 cyclic actual values exceeded. Meant is the GDP mapping between fieldbus controller and controller. ⇒ Change to phase 3 (Safe-Op) has been aborted.
1541	0x0605	Invalid IDN in signal status word ▷S-0-0144◀	Mapping error of the parameter signal status word (▷S-0-0144◀). Input of an invalid IDN. The invalid IDN is added to the list „invalid operation data communication phase 3“ (▷S-0-0022◀).
1542	0x0606	Invalid IDN in config. list MDT ▷S-0-0024◀	Invalid IDN set in config list MDT (▷S-0-0024◀ , see ▷S-0-0188◀ . ⇒ Change to phase 3 (Safe-Op) has been aborted.
1543	0x0607	Number of cyclic set values exceeded limit (mapping drive controller ⇔ fieldbus controller)	Permitted number of 16 cyclic set values exceeded. Meant is the GDP mapping between fieldbus controller and controller. ⇒ Change to phase 3 (Safe-Op) has been aborted.
1544	0x0608	Length of config. data in MDT exceeded	Permitted length see ▷S-0-0186◀ . ⇒ Change to phase 3 (Safe-Op) has been aborted.
1545	0x0609	Invalid IDN in signal control word ▷S-0-0145◀	Invalid IDN set in signal control word. The invalid IDN is added to the list „invalid operation data communication phase 3“ (▷S-0-0022◀). ⇒ Change to phase 3 (Safe-Op) has been aborted.
1546	0x060A	GDP mapping of cyclic data failed	GDP mapping of cyclic data failed (controller ⇒ fieldbus controller) ⇒ Change to phase 3 (Safe-Op) has been aborted.
1547	0x060B	Error DC configuration	SoE: Error detected at DC configuration (Distributed Clocks).

Error No. dec	Error No. hex	Error text	Error description
1548	0x060C	Timeout while waiting for synchronization	Timeout while waiting for the synchronization message. ⇒ Change to phase 3 (Safe-Op) has been aborted.
1549	0x060D	Invalid communication cycle time ▶S-0-0002◀	Parameter ▶S-0-0002◀ has not been read correctly via GDP. ⇒ Change to phase 3 (Safe-Op) has been aborted.
1550	0x060E	Command cannot be executed in this drive state	Several commands can be executed only in a enabled state others can be executed only in disabled state.
1551	0x060F	Invalid command configuration	Invalid setting of additional modes of the command.
1552	0x0610	External encoder not available	The external encoder are to be used but is not available. This error message can be generated by a command for example.
1553	0x0611	Storage of the operation data failed	Meant is the incorrect storage of S parameters from the list ▶S-0-0192◀ to the flash.
1554	0x0612	Writing of the coordinate initial value of the encoder failed	Writing of the coordinate initial value of the encoder failed executing command 197.

9.5 Error reset

In order to enable an controller, which was inhibited by an error message, the following must be executed via Sercos:

- Read out status 1 diagnostic ([▶S-0-0011◀](#) and [▶S-0-0129◀](#))
- Execute command for error acknowledge (CMD 0099)
- Inhibit and enable drive via Sercos control word bits 14 and 15 (also see [▶page 19◀](#))

9.6 Clearing the warning bit

The warning bit (bit 12) in the drive status is set by changing the warning message class 2 diagnostic ([▶S-0-0012◀](#)). After reading class 2 diagnostic ([▶S-0-0012◀](#)) the status bit is cleared.

9.7 Clearing the message bit

The message bit (bit 11) in the drive status is set by changing the warning message class 3 diagnostic ([▶S-0-0013◀](#)). After reading class 3 diagnostic ([▶S-0-0013◀](#)) the status bit is cleared.



APPENDIX A - DEFINITIONS AND ABBREVIATIONS

A.1 Definitions

The following definitions are valid for the application manual:

- **Access procedure:**
Procedure by which one station gains access to the network and transmits data.
- **Actual values**
Measured process values.
- **Attenuation:**
Fact that the optical power at the receiver is less than at the transmitter.
- **Bit stuffing:**
Procedure by which after five logical 1s, the transmitter automatically inserts a zero which is then removed again by the receiver. This zero causes a change in signal edges which makes it possible for the receiver to retrieve a receiving clock (see ISO/IEC 3309).
- **Broadcast:**
Transmission to all devices in a network without any acknowledgement by the receiver.
- **Coded character set:**
Set of unambiguous rules that establish a character set and one-to-one relationship between the characters of the set and their representation by one or more bit combinations.
- **Communication cycle:**
Accumulation of all telegrams between two master synchronization telegrams.
- **Control word:**
Two adjacent bytes inside the master data telegram containing commands for the addressed drive.
- **Cycle time:**
Time span between two consecutive cyclically recurring events.
- **Cyclic communication:**
The periodic exchange of telegrams

- **Cyclic data:**
The part of the telegram which does not change its meaning during cyclic operation.
- **Cyclic operation:**
Devices in the communication network are addressed and queried one after the other at fixed, constant time intervals.
- **Data exchange - non cyclic (service channel):**
Transmission of information after a request was sent by the master.
- **Digital phase locked loop (DPLL):**
Circuit which retrieves the receiving clock from the received data stream.
- **Drive enable:**
Command to close the control loop.
- **Drive On:**
Command that the power stage can be activated.
- **Drive telegram (AT):**
Telegram send by the drive (slave).
- **Feedforward:**
Set value used to compensate the lag in the control loop.
- **Fiber-optic cable:**
Transmission medium for the serial data transmission of optical signals.
- **Fill signals:**
Sequence of seven 1s followed by a 0.
- **F-SMA-connector:**
Connector meeting the F-SMA standard in accordance with IEC 60874-2.
- **ISO/OSI-reference model:**
Communication layers which are architecture guidelines for defining communication protocols (see ISO/IEC 7498)
- **Machine zero point:**
Machine related point (in each axis) to which all position data are referred to.
- **Master data telegram (MDT):**
Telegram transmitted by the master sending data to the slaves in a single ring.
- **Master synchronization telegram (MST):**
Telegram transmitted by the master which sends a time synchronization signal to the slaves in a single ring.
- **Master:**
Station which assigns the other stations in the ring (i. e. slaves) the right to transmit.
- **Non-cyclic transmission:**
Non-cyclic data exchange of data at the request of the master.
- **NRZI (No return to zero inverted) (data coding):**
Signal exchanges taking place only at regular, fixed points in time in synchronization with the transmitting clock pulse of the bit rate. A signal edge change is assigned to a logical 0 only.
- **Operating cycle:**
Period of the control loop within the drive or the control unit.

- **Physical layer (bit transmission layer):**
First layer of the ISO-OSI reference model layers in which the bit transmission is defined.
- **Protocol:**
Convention about the data formats , time sequences, and error correction in the data exchange of communication system.
- **Recovery of clock:**
Sufficiently frequent alternation of the signal, which makes it possible for the receiver to retrieve the receiving clock from the data stream with the help of the phase locked loop.
- **Reference point:**
Actual-system related point (in each axis) to which the actual values and setpoints are referred to after a homing procedure.
- **Repeater function:**
Telegram that has been received is passed on cycle synchronous and logically unchanged to the next station on the ring.
- **Ring structure:**
Network topology in which the transmission medium is routed from station to station in the form of a ring. The information is transmitted only in one direction.
- **Scaling parameters:**
Scaling determines the significance of the transferred operation data.
- **Slave**
Device in the ring which is assigned the right to transmit by the master.
- **Status word:**
Two adjacent bytes inside the drive telegram containing status information.
- **System interface:**
 - Physical features of interface.
 - Protocol and access method.
 - Applications.
- **Telegram address field:**
Address field (eight bits containing the address of the device).
- **Telegram delimiter:**
Beginning- and ending identifiers of a telegram (eight bits: 01111110).
- **Telegram**
Message

A.2 Abbreviations

In this application handbook the following abbreviations are used.

AT	Drive telegram
BA	Operating mode
BACI	System-internal Baumüller interface
C1D	Error message of class 1 diagnostic
C2D	Message of class 2 diagnostic
C3D	Message of class 3 diagnostic
CP0	Communication phase 0
CP1	Communication phase 1
CP2	Communication phase 2
CP3	Communication phase 3
IDN	Parameter number
LSB	Least significant bit
MDT	Master data telegram
MST	Master send telegram
NC	Numeric control
T_1	Transmission time drive telegram
T_{1min}	Transmission starting time AT
T_3	Term valid for set value
T_4	Measuring time actual values
T_{4min}	Minimum actual value sensing time
T_{ATAT}	Transmit to transmit recovery time
T_{ATMT}	Transmit/receive transition time
T_{ATMT}	Transmit/receive transition time
T_{MTSG}	Set values processing time
T_{MTSY}	Receive to receive recovery time
T_{Ncyc}	Control unit cycle time

APPENDIX B - LIST OF PARAMETERS

B.1 List of P parameters

This list contains the drive controller parameters which can be addressed via Sercos IDN. Parameter details see parameter manuals of b maXX 2500, 3300 and 5000. In this manual the Controller P No. has to be used.



NOTE!

The P parameters are read and written directly and without conversion („raw value“) using the internal standardization. But the unit of the P parameter is displayed for the standardized form and corresponds with the display in ProDrive („raw unit“). The conversion factor of display ProDrive to internal standardization can be found in column „factor“ of the parameter overview in the parameter manuals.

Sercos IDN P-0-	Name	Type	Controller P No.	Function block
0001	System clock	UDINT	1.1.0.0	System 1
0002	RT0 cycle time	FLOAT	1.8.0.0	System 1
0003	Task fieldbus cycle time	UDINT	1.10.0.0	System 1
0010	n=0 limit	FLOAT	6.1.0.0	Diagnostic
0011	Standstill status	INT	6.2.0.0	Diagnostic
0012	Active torque direction	UINT	6.3.0.0	Diagnostic
0013	Positive overspeed limit	FLOAT	6.5.0.0	Diagnostic
0014	Negative overspeed limit	FLOAT	6.6.0.0	Diagnostic
0015	Max. pos. speed deviation	FLOAT	6.7.0.0	Diagnostic
0016	Max. neg. speed deviation	FLOAT	6.8.0.0	Diagnostic
0017	Speed error response time	FLOAT	6.11.0.0	Diagnostic
0018	Speed actual value > speed ON threshold	FLOAT	6.12.0.0	Diagnostic
0019	Speed actual value > speed OFF threshold	FLOAT	6.13.0.0	Diagnostic
0020	Velocity window percentage	UINT	6.14.0.0	Diagnostic
0022	Load factor active power	FLOAT	6.20.0.0	Diagnostic
0023	Blockade time limit 1	FLOAT	6.21.0.0	Diagnostic
0024	Blockade time limit 2	FLOAT	6.22.0.0	Diagnostic
0025	Power unit maximal current	FLOAT	6.25.0.0	Diagnostic

B.1 List of P parameters

Sercos IDN P-0-	Name	Type	Controller P No.	Function block
0026	Power unit nominal current	FLOAT	6.26.0.0	Diagnostic
0027	Power unit Ixt actual value	FLOAT	6.27.0.0	Diagnostic
0028	Motor I2t actual value	FLOAT	6.28.0.0	Diagnostic
0029	Motor I2t threshold	FLOAT	6.29.0.0	Diagnostic
0030	Motor current RMS value	FLOAT	6.30.0.0	Diagnostic
0031	Motor active power smoothed	FLOAT	6.32.0.0	Diagnostic
0032	Motor I2t warning threshold	FLOAT	6.39.0.0	Diagnostic
0033	Smoothing time electr. motor power display	FLOAT	6.42.0.0	Diagnostic
0034	Motor I2t monitoring mode	UINT	6.43.0.0	Diagnostic
0035	Encoder error mask	UDINT	14.17.0.0	Encoder monitoring
0036	Position actual value error threshold	FLOAT	14.21.0.0	Encoder monitoring
0037	Position actual value error	FLOAT	14.22.0.0	Encoder monitoring
0040	Adaptation time parameter	UDINT	18.7.0.0	Controller
0041	Controller options	DWORD	18.9.0.0	Controller
0042	Position controller status	DWORD	18.10.0.0	Controller
0043	w1 position set value	FLOAT	18.11.0.0	Controller
0044	x1 position actual value	FLOAT	18.12.0.0	Controller
0045	e1 position controller error	FLOAT	18.13.0.0	Controller
0046	Kv position controller	FLOAT	18.14.0.0	Controller
0047	w2 feedforward factor	FLOAT	18.15.0.0	Controller
0048	Gear factor	FLOAT	18.16.0.0	Controller
0049	w2 speed feed forward	FLOAT	18.17.0.0	Controller
0050	Speed controller status	DWORD	18.20.0.0	Controller
0051	w2 speed set value	FLOAT	18.21.0.0	Controller
0052	x2 speed actual value	FLOAT	18.22.0.0	Controller
0053	e2 speed error	FLOAT	18.23.0.0	Controller
0054	Kp speed controller	FLOAT	18.24.0.0	Controller
0055	Tn speed controller	FLOAT	18.25.0.0	Controller
0056	Derivative time speed controller	FLOAT	18.26.0.0	Controller
0057	Time constant speed act. value filter	FLOAT	18.27.0.0	Controller
0058	Integral term speed controller	FLOAT	18.29.0.0	Controller
0059	Derivate term speed controller	FLOAT	18.30.0.0	Controller
0060	Position controller output	FLOAT	18.31.0.0	Controller
0061	w3 acceleration set value	FLOAT	18.35.0.0	Controller
0062	w3 feedforward factor acceleration	FLOAT	18.36.0.0	Controller
0063	w3 feedforward brake	FLOAT	18.37.0.0	Controller
0064	w3 feedforward act. factor	FLOAT	18.38.0.0	Controller
0065	w3 feedforward time constant	FLOAT	18.39.0.0	Controller
0066	Ks scaling factor	FLOAT	18.40.0.0	Controller
0067	Isq set value unlimited	FLOAT	18.45.0.0	Controller
0068	isq set value for torque control	INT	18.50.0.0	Controller
0069	Position act value rev + angle	UDINT	18.54.0.0	Controller
0070	Position act value angle	UDINT	18.55.0.0	Controller
0071	Position act value revolutions	UDINT	18.56.0.0	Controller
0072	Position set value rev + angle	UDINT	18.57.0.0	Controller
0073	Position set value angle	UDINT	18.58.0.0	Controller
0074	Position set value revolutions	UDINT	18.59.0.0	Controller
0075	Position error rev + angle	DINT	18.60.0.0	Controller

Sercos IDN P-0-	Name	Type	Controller P No.	Function block
0076	Position error angle	DINT	18.61.0.0	Controller
0077	Position error revolutions	DINT	18.62.0.0	Controller
0078	Speed additional value	FLOAT	18.68.0.0	Controller
0079	Speed set value	FLOAT	18.69.0.0	Controller
0080	w2 feedforward time constant	FLOAT	18.70.0.0	Controller
0081	Speed set value positive limit	FLOAT	18.71.0.0	Controller
0082	Speed set value negative limit	FLOAT	18.72.0.0	Controller
0084	Smoothing time speed set value filter	FLOAT	18.33.0.0	Controller
0085	Display smoothing time filter	FLOAT	18.18.0.0	Controller
0087	Center frequency x2 actual value notch filter	FLOAT	18.42.0.0	Controller
0088	Band width x2 speed actual value notch filter	FLOAT	18.43.0.0	Controller
0089	x2 speed actual value not filtered	FLOAT	18.44.0.0	Controller
0090	x3 acceleration actual value	FLOAT	18.73.0.0	Controller
0091	x3 acceleration smoothing time	FLOAT	18.74.0.0	Controller
0092	w3 acceleration set value	FLOAT	18.75.0.0	Controller
0100	Number of motors	UDINT	19.1.0.0	Motor management
0101	Motor manager status	UINT	19.3.0.0	Motor management
0102	Max. drive current	FLOAT	19.6.0.0	Motor management
0103	Maximum field current	FLOAT	19.7.0.0	Motor management
0104	Max. available torque current	FLOAT	19.8.0.0	Motor management
0105	Field current reference value	FLOAT	19.9.0.0	Motor management
0106	Motor nominal torque current	FLOAT	19.10.0.0	Motor management
0107	Back-EMF feed forward	FLOAT	19.11.0.0	Motor management
0108	Frequency current filter	FLOAT	19.12.0.0	Motor management
0109	Isq Additive Set Value	FLOAT	19.17.0.0	Motor management
0110	Phi electric	UINT	19.18.0.0	Motor management
0111	Motor actual slip frequency	FLOAT	19.30.0.0	Motor management
0112	Rotor time constant	FLOAT	19.32.0.0	Motor management
0113	Notch Position O.K.	UINT	19.50.0.0	Motor management
0114	Current ref. for notch position detection	FLOAT	19.51.0.0	Motor management
0115	Modus motor operating mode	UINT	19.52.0.0	Motor management
0116	Effective maximum current	FLOAT	19.5.0.0	Motor management
0130	Isq set value	FLOAT	47.1.0.0	Current controller
0131	Isd set value	FLOAT	47.2.0.0	Current controller
0132	Isq actual value	FLOAT	47.3.0.0	Current controller
0133	Isd actual value	FLOAT	47.4.0.0	Current controller
0134	Isq actual value filtered	FLOAT	47.5.0.0	Current controller
0135	Isd actual value filtered	FLOAT	47.6.0.0	Current controller
0136	P gain 4 kHz Iq	FLOAT	47.7.0.0	Current controller
0137	Integral action time Iq	FLOAT	47.8.0.0	Current controller
0138	P gain 4 kHz Id	FLOAT	47.9.0.0	Current controller
0139	Integral action time Id	FLOAT	47.10.0.0	Current controller
0140	Back EMF feed forward	FLOAT	47.26.0.0	Current controller
0141	PWM MSVM threshold	UINT	47.40.0.0	Current controller
0142	Motor Rho	UINT	47.47.0.0	Current controller
0143	Dead time compensation	FLOAT	47.50.0.0	Current controller
0144	Enable I Prediction	UINT	47.51.0.0	Current controller
0201	Error command	UINT	100.1.0.0	Info

B.1 List of P parameters

Sercos IDN P-0-	Name	Type	Controller P No.	Function block
0202	Error count	UINT	100.2.0.0	Info
0205	First error	UDINT	100.5.0.0	Info
0206	Error communication mode	UINT	100.7.0.0	Info
0207	Error reaction actual value	INT	100.8.0.0	Info
0208	Error reaction set value	INT	100.9.0.0	Info
0220	Firmware number	UDINT	102.1.0.0	Firmware management
0221	Firmware version	UDINT	102.2.0.0	Firmware management
0222	Firmware type	UDINT	102.3.0.0	Firmware management
0223	Firmware build number	UDINT	102.4.0.0	Firmware management
0224	Firmware name	STRING	102.5.0.0	Firmware management
0225	Firmware version info	STRING	102.6.0.0	Firmware management
0226	Firmware time stamp	STRING	102.7.0.0	Firmware management
0227	Bootloader 0 version	STRING	102.8.0.0	Firmware management
0228	Bootloader 1 version	STRING	102.9.0.0	Firmware management
0229	FPGA version	UDINT	102.10.0.0	Firmware management
0230	Bootloader flags	UDINT	102.11.0.0	Firmware management
0231	Expected system FPGA version	UDINT	102.13.0.0	Firmware management
0232	FPGA version	UDINT	102.14.0.0	Firmware management
0233	FPGA firmware number	UDINT	102.15.0.0	Firmware management
0234	Fieldbus controller firmware number	UDINT	102.18.0.0	Firmware management
0235	Fieldbus controller firmware version	UDINT	102.19.0.0	Firmware management
0236	Fieldbus controller firmware version time stamp	STRING	102.20.0.0	Firmware management
0237	Fieldbus controller firmware type	UDINT	102.21.0.0	Firmware management
0238	Fieldbus controller firmware build number	UDINT	102.22.0.0	Firmware management
0239	Board data command	UINT	102.23.0.0	Firmware management
0240	Board data status	UDINT	102.24.0.0	Firmware management
0241	Hardware board identification	STRING	102.25.0.0	Firmware management
0242	Circuit board assembly	STRING	102.26.0.0	Firmware management
0243	Hardware date	STRING	102.28.0.0	Firmware management
0244	Hardware name	STRING	102.29.0.0	Firmware management
0245	Controller serial number	UDINT	102.30.0.0	Firmware management
0246	Controller article number	UDINT	102.31.0.0	Firmware management
0247	Device serial number	UDINT	102.32.0.0	Firmware management
0248	Device article number	UDINT	102.33.0.0	Firmware management
0249	Device type code	STRING	102.35.0.0	Firmware management
0250	Expected OWE serial number	UDINT	102.36.0.0	Firmware management
0260	Command	DINT	105.1.0.0	Data set management
0261	Status	UDINT	105.2.0.0	Data set management
0262	Data set name	STRING	105.4.0.0	Data set management
0263	Data set Id	UDINT	105.5.0.0	Data set management
0264	Data set index	UINT	105.6.0.0	Data set management
0265	Valid data sets	WORD	105.7.0.0	Data set management
0266	Data set source	UINT	105.8.0.0	Data set management
0267	Data set destination	UINT	105.9.0.0	Data set management
0268	Boot mode SAF-XXX	WORD	105.10.0.0	Data set management
0269	Name of complete parameter set	STRING	105.11.0.0	Data set management
0270	Error count	UINT	105.12.0.0	Data set management
0300	Control word 1	WORD	108.1.0.0	Drive manager

Sercos IDN P-0-	Name	Type	Controller P No.	Function block
0301	Status word 1	WORD	108.3.0.0	Drive manager
0302	Status word 2	DWORD	108.5.0.0	Drive manager
0303	Drive status	UINT	108.6.0.0	Drive manager
0304	Communication source	WORD	108.7.0.0	Drive manager
0305	Status digital inputs drive manager	WORD	108.8.0.0	Drive manager
0306	Parameter selection status bit 14	UDINT	108.9.0.0	Drive manager
0307	Bit pattern status bit 14	UDINT	108.10.0.0	Drive manager
0308	Parameter selection status bit 15	UDINT	108.11.0.0	Drive manager
0309	Bit pattern status bit 15	UDINT	108.12.0.0	Drive manager
0310	QUICK STOP reaction code	INT	108.13.0.0	Drive manager
0311	SHUTDOWN reaction code	INT	108.14.0.0	Drive manager
0312	DISABLE OPERATION reaction code	INT	108.15.0.0	Drive manager
0313	Status internal limits	DWORD	108.16.0.0	Drive manager
0314	Mask for status internal limit	DWORD	108.17.0.0	Drive manager
0315	Delay for quickstop input	UINT	108.18.0.0	Drive manager
0316	Time for reducing torque	FLOAT	108.19.0.0	Drive manager
0317	Parking shaft control word	UINT	108.20.0.0	Drive manager
0318	Parking shaft status word	WORD	108.21.0.0	Drive manager
0320	Operation mode set	INT	109.1.0.0	Operation modes
0321	Operation mode act	INT	109.2.0.0	Operation modes
0330	Status	DWORD	110.1.0.0	Ramp function generator
0331	Mode	DWORD	110.2.0.0	Ramp function generator
0332	Output	DINT	110.3.0.0	Ramp function generator
0333	Input 32 bit	DINT	110.4.0.0	Ramp function generator
0334	Input 16 bit	INT	110.5.0.0	Ramp function generator
0335	Ramp-up time	UDINT	110.6.0.0	Ramp function generator
0336	Ramp-down time	UDINT	110.7.0.0	Ramp function generator
0337	Quick stop time	UDINT	110.8.0.0	Ramp function generator
0338	S-curve ramp-up time	UDINT	110.9.0.0	Ramp function generator
0339	S-curve ramp-down time	UDINT	110.10.0.0	Ramp function generator
0340	Smoothing	UINT	110.11.0.0	Ramp function generator
0341	Set value zone	UDINT	110.12.0.0	Ramp function generator
0342	Maximum drive speed	FLOAT	110.13.0.0	Ramp function generator
0343	Input max. amount	UDINT	110.15.0.0	Ramp function generator
0344	Input min. amount	UDINT	110.16.0.0	Ramp function generator
0345	Input 32 bit additive	DINT	110.17.0.0	Ramp function generator
0346	Braking time for controlled stop	UDINT	110.20.0.0	Ramp function generator
0347	SS1 stop time	UDINT	110.21.0.0	Ramp function generator
0348	Active cycle time ramp function generator	FLOAT	110.22.0.0	Ramp function generator
0350	Status	WORD	111.1.0.0	Set value manager
0351	Position set value rev	UDINT	111.2.0.0	Set value manager
0352	Position set value angle	UDINT	111.3.0.0	Set value manager
0353	Speed set value	DINT	111.4.0.0	Set value manager
0354	Acceleration set value	DINT	111.5.0.0	Set value manager
0355	Interpolation mode	UINT	111.6.0.0	Set value manager
0356	External speed precontrol	FLOAT	111.7.0.0	Set value manager
0357	External acceleration precontrol	FLOAT	111.7.0.0	Set value manager
0358	Jerk set value	DINT	111.9.0.0	Set value manager

B.1 List of P parameters

Sercos IDN P-0-	Name	Type	Controller P No.	Function block
0370	Mode	DWORD	132.1.0.0	Set value generator
0371	Status	DWORD	132.2.0.0	Set value generator
0372	Target number output	UDINT	132.4.0.0	Set value generator
0373	Output	FLOAT	132.3.0.0	Set value generator
0374	Set value Set value1	FLOAT	132.10.0.0	Set value generator
0375	Duration zone 2	UDINT	132.13.0.0	Set value generator
0376	Duration zone 1	UDINT	132.11.0.0	Set value generator
0377	Set value2	FLOAT	132.12.0.0	Set value generator
0378	Set value3	FLOAT	132.14.0.0	Set value generator
0379	Duration zone 3	UDINT	132.15.0.0	Set value generator
0380	Set value 4	FLOAT	132.16.0.0	Set value generator
0381	Duration zone 4	UDINT	132.17.0.0	Set value generator
0401	Status digital inputs	DWORD	116.1.0.0	Digital inputs
0402	Mode digital input 1	WORD	116.2.0.0	Digital inputs
0403	DI1 axis index	UINT	116.3.0.0	Digital inputs
0404	Target number digital input 1	UDINT	116.4.0.0	Digital inputs
0405	Bit selection digital input 1	DWORD	116.5.0.0	Digital inputs
0406	Set bit pattern for LOW state digital input 1	DWORD	116.6.0.0	Digital inputs
0407	Set bit pattern for HIGH state digital input 1	DWORD	116.7.0.0	Digital inputs
0408	Mode digital input 2	WORD	116.8.0.0	Digital inputs
0409	DI2 axis index	UINT	116.9.0.0	Digital inputs
0410	Target number digital input 2	UDINT	116.10.0.0	Digital inputs
0411	Bit selection digital input 2	DWORD	116.11.0.0	Digital inputs
0412	Set bit pattern for LOW state digital input 2	DWORD	116.12.0.0	Digital inputs
0413	Set bit pattern for HIGH state digital input 2	DWORD	116.13.0.0	Digital inputs
0414	Mode digital input 3	WORD	116.14.0.0	Digital inputs
0415	DI3 axis index	UINT	116.15.0.0	Digital inputs
0416	Target number digital input 3	UDINT	116.16.0.0	Digital inputs
0417	Bit selection digital input 3	DWORD	116.17.0.0	Digital inputs
0418	Set bit pattern for LOW state digital input 3	DWORD	116.18.0.0	Digital inputs
0419	Set bit pattern for HIGH state digital input 3	DWORD	116.19.0.0	Digital inputs
0420	Mode digital input 4	WORD	116.20.0.0	Digital inputs
0421	DI4 axis index	UINT	116.21.0.0	Digital inputs
0422	Target number digital input 4	UDINT	116.22.0.0	Digital inputs
0423	Bit selection digital input 4	DWORD	116.23.0.0	Digital inputs
0424	Set bit pattern for LOW state digital input 4	DWORD	116.24.0.0	Digital inputs
0425	Set bit pattern for HIGH state digital input 4	DWORD	116.25.0.0	Digital inputs
0426	Mode digital input 5	WORD	116.26.0.0	Digital inputs
0427	DI5 axis index	UINT	116.27.0.0	Digital inputs
0428	Target number digital input 5	UDINT	116.28.0.0	Digital inputs
0429	Bit selection digital input 5	DWORD	116.29.0.0	Digital inputs
0430	Set bit pattern for LOW state digital input 5	DWORD	116.30.0.0	Digital inputs
0431	Set bit pattern for HIGH state digital input 5	DWORD	116.31.0.0	Digital inputs
0432	Mode digital input 6	WORD	116.32.0.0	Digital inputs
0433	DI6 axis index	UINT	116.33.0.0	Digital inputs
0434	Target number digital input 6	UDINT	116.34.0.0	Digital inputs
0435	Bit selection digital input 6	DWORD	116.35.0.0	Digital inputs
0436	Set bit pattern for LOW state digital input 6	DWORD	116.36.0.0	Digital inputs

Sercos IDN P-0-	Name	Type	Controller P No.	Function block
0437	Set bit pattern for HIGH state digital input 6	DWORD	116.37.0.0	Digital inputs
0438	Mode digital input 7	WORD	116.38.0.0	Digital inputs
0439	DI7 axis index	UINT	116.39.0.0	Digital inputs
0440	Target number digital input 7	UDINT	116.40.0.0	Digital inputs
0441	Bit selection digital input 7	DWORD	116.41.0.0	Digital inputs
0442	Set bit pattern for LOW state digital input 7	DWORD	116.42.0.0	Digital inputs
0443	Set bit pattern for HIGH state digital input 7	DWORD	116.43.0.0	Digital inputs
0444	Mode digital input 8	WORD	116.44.0.0	Digital inputs
0445	DI8 axis index	UINT	116.45.0.0	Digital inputs
0446	Target number digital input 8	UDINT	116.46.0.0	Digital inputs
0447	Bit selection digital input 8	DWORD	116.47.0.0	Digital inputs
0448	Set bit pattern for LOW state digital input 8	DWORD	116.48.0.0	Digital inputs
0449	Set bit pattern for HIGH state digital input 8	DWORD	116.49.0.0	Digital inputs
0451	Status digital outputs	DWORD	117.1.0.0	Digital outputs
0452	Mode digital output 1	WORD	117.2.0.0	Digital outputs
0453	DO1 Source axis index	UINT	117.3.0.0	Digital outputs
0454	Source number digital output 1	UDINT	117.4.0.0	Digital outputs
0455	Bit selection digital output 1	DWORD	117.5.0.0	Digital outputs
0456	Compare bit pattern digital output 1	DWORD	117.6.0.0	Digital outputs
0457	Mode digital output 2	WORD	117.7.0.0	Digital outputs
0458	DO2 Source axis index	UINT	117.8.0.0	Digital outputs
0459	Source number digital output 2	UDINT	117.9.0.0	Digital outputs
0460	Bit selection digital output 2	DWORD	117.10.0.0	Digital outputs
0461	Compare bit pattern digital output 2	DWORD	117.11.0.0	Digital outputs
0462	Mode digital output 3	WORD	117.12.0.0	Digital outputs
0463	DO3 source axis index	UINT	117.13.0.0	Digital outputs
0464	Source number digital output 3	UDINT	117.14.0.0	Digital outputs
0465	Bit selection digital output 3	DWORD	117.15.0.0	Digital outputs
0466	Compare bit pattern digital output 3	DWORD	117.16.0.0	Digital outputs
0467	Mode digital output 4	UINT	117.17.0.0	Digital outputs
0468	DO4 source axis index	UINT	117.18.0.0	Digital outputs
0469	Source number digital output 4	UDINT	117.19.0.0	Digital outputs
0470	Bit selection digital output 4	DWORD	117.20.0.0	Digital outputs
0471	Compare bit pattern digital output 4	DWORD	117.21.0.0	Digital outputs
0481	Time Constant PT1 analog input 1	FLOAT	144.1.0.0	Analog inputs
0482	Scaling factor analog input 1	FLOAT	144.2.0.0	Analog inputs
0483	Offset analog input 1	FLOAT	144.3.0.0	Analog inputs
0484	Threshold analog input 1	FLOAT	144.4.0.0	Analog inputs
0485	Value analog input 1	FLOAT	144.5.0.0	Analog inputs
0486	Target number analog input 1	UDINT	144.6.0.0	Analog inputs
0487	AI1 axis index	UINT	144.7.0.0	Analog inputs
0488	Time constant PT1 analog input 2	FLOAT	144.10.0.0	Analog inputs
0489	Scaling factor analog input 2	FLOAT	144.11.0.0	Analog inputs
0490	Offset analog input 2	FLOAT	144.12.0.0	Analog inputs
0491	Threshold analog input 2	FLOAT	144.13.0.0	Analog inputs
0492	Value Analog Input 2	FLOAT	144.14.0.0	Analog inputs
0493	Target number analog input 2	UDINT	144.15.0.0	Analog inputs
0494	AI2 axis index	UINT	144.16.0.0	Analog inputs

B.1 List of P parameters

Sercos IDN P-0-	Name	Type	Controller P No.	Function block
0495	Time slot analog inputs	UINT	144.20.0.0	Analog inputs
0500	Status	DWORD	119.1.0.0	Jogging
0501	Mode	UINT	119.2.0.0	Jogging
0502	Jogging speed	UDINT	119.3.0.0	Jogging
0503	Jogging acceleration	UDINT	119.4.0.0	Jogging
0504	Jogging deceleration	UDINT	119.5.0.0	Jogging
0505	Jogging maximum jerk	UDINT	119.6.0.0	Jogging
0510	Status	DWORD	136.1.0.0	Synchr. position target setting
0511	Mode	WORD	136.2.0.0	Synchr. position target setting
0512	Target position	UDINT	136.3.0.0	Synchr. position target setting
0513	Position offset	DINT	136.4.0.0	Synchr. position target setting
0514	Target angle	UDINT	136.5.0.0	Synchr. position target setting
0515	Angle offset	DINT	136.6.0.0	Synchr. position target setting
0516	Offset speed	DINT	136.7.0.0	Synchr. position target setting
0517	Output position set value	UDINT	136.8.0.0	Synchr. position target setting
0518	Output speed set value	DINT	136.9.0.0	Synchr. position target setting
0519	Output acceleration set value	DINT	136.10.0.0	Synchr. position target setting
0520	Active interpolation interval	UINT	136.11.0.0	Synchr. position target setting
0521	Output angle set value	UDINT	136.12.0.0	Synchr. position target setting
0522	Smoothing time position set value	FLOAT	136.13.0.0	Synchr. position target setting
0523	Speed set value unlimited	DINT	136.14.0.0	Synchr. position target setting
0524	Output speed set value 32 bit	DINT	136.15.0.0	Synchr. position target setting
0540	Status	WORD	145.1.0.0	Synchronous mode
0541	Mode	DWORD	145.2.0.0	Synchronous mode
0542	Gear slave shaft revolutions	DINT	145.3.0.0	Synchronous mode
0543	Gear master shaft revolutions	DINT	145.4.0.0	Synchronous mode
0544	Speed limit master shaft	UDINT	145.5.0.0	Synchronous mode
0545	Synchronization velocity window	UDINT	145.6.0.0	Synchronous mode
0546	Synchronization acceleration	UDINT	145.7.0.0	Synchronous mode
0547	Synchronization deceleration	UDINT	145.8.0.0	Synchronous mode
0548	Synchronization maximum jerk	UDINT	145.9.0.0	Synchronous mode
0549	Virtual master speed set value	DINT	145.10.0.0	Synchronous mode
0550	Virtual master set value cycle time	UINT	145.11.0.0	Synchronous mode
0551	Master speed	DINT	145.12.0.0	Synchronous mode
0552	Master position revolutions	UDINT	145.13.0.0	Synchronous mode
0553	Master position angle	UDINT	145.14.0.0	Synchronous mode
0554	Virtual master speed set value additive 1	DINT	145.15.0.0	Synchronous mode
0555	Virtual master speed set value additive 2	DINT	145.16.0.0	Synchronous mode
0556	Master axis position offset	DINT	145.17.0.0	Synchronous mode
0557	Master axis angle offset	DINT	145.18.0.0	Synchronous mode
0560	Status	DWORD	149.1.0.0	Spindle positioning
0561	Mode	DWORD	149.2.0.0	Spindle positioning
0562	Spindle angle position	UDINT	149.3.0.0	Spindle positioning
0563	Spindle positioning speed	UDINT	149.4.0.0	Spindle positioning
0564	Spindle acceleration bipolar	UDINT	149.5.0.0	Spindle positioning
0565	Spindle maximum jerk	UDINT	149.6.0.0	Spindle positioning
0566	Timeout trigger signal	UINT	149.8.0.0	Spindle positioning
0567	Spindle relative offset	UDINT	149.9.0.0	Spindle positioning

Sercos IDN P-0-	Name	Type	Controller P No.	Function block
0568	Active target position	UDINT	149.10.0.0	Spindle positioning
0569	Output position set value	UDINT	149.11.0.0	Spindle positioning
0570	Output speed set value	DINT	149.12.0.0	Spindle positioning
0571	Output acceleration set value	DINT	149.13.0.0	Spindle positioning
0600	Target position	UDINT	118.9.0.0	Positioning
0601	Target mode	INT	118.10.0.0	Positioning
0602	Speed	UDINT	118.11.0.0	Positioning
0603	Acceleration	UDINT	118.12.0.0	Positioning
0604	Deceleration	UDINT	118.13.0.0	Positioning
0605	Jerk	UDINT	118.14.0.0	Positioning
0606	Smoothing time	UINT	118.15.0.0	Positioning
0607	Relative target position	DINT	118.16.0.0	Positioning
0610	Status	DWORD	118.1.0.0	Positioning
0611	Mode	DWORD	118.2.0.0	Positioning
0612	Output position set value	UDINT	118.3.0.0	Positioning
0613	Output speed set value	DINT	118.4.0.0	Positioning
0614	Output acceleration set value	DINT	118.5.0.0	Positioning
0615	Record number actual	UINT	118.6.0.0	Positioning
0616	Clip environment 1	UDINT	118.7.0.0	Positioning
0617	Clip environment 2	UDINT	118.8.0.0	Positioning
0618	Remaining distance	UDINT	118.17.0.0	Positioning
0619	Timeout	UINT	118.18.0.0	Positioning
0620	Modulo value	UDINT	118.20.0.0	Positioning
0621	Positioning duration	UDINT	118.21.0.0	Positioning
0640	Status	DWORD	120.1.0.0	Homing
0641	Mode	UINT	120.2.0.0	Homing
0642	Home position	UDINT	120.3.0.0	Homing
0643	Homing method	INT	120.4.0.0	Homing
0644	Homing speed	UDINT	120.5.0.0	Homing
0645	Homing final speed	UDINT	120.6.0.0	Homing
0646	Homing acceleration	UDINT	120.7.0.0	Homing
0647	Homing deceleration	UDINT	120.8.0.0	Homing
0648	Homing maximum jerk	UDINT	120.9.0.0	Homing
0649	Homing encoder offset	UINT	120.10.0.0	Homing
0650	Homing blocking time	UINT	120.11.0.0	Homing
0651	Homing torque limit	UINT	120.12.0.0	Homing
0652	Output speed set value	DINT	120.13.0.0	Homing
0653	Output acceleration set value	DINT	120.14.0.0	Homing
0654	Encoder angle at reference switch	UDINT	120.15.0.0	Homing
0670	Positioning general mode	WORD	121.1.0.0	Positioning general parameters
0671	Status limit switch	WORD	121.2.0.0	Positioning general parameters
0672	Negative SW limit Switch	UDINT	121.3.0.0	Positioning general parameters
0673	Positive SW limit switch	UDINT	121.4.0.0	Positioning general parameters
0674	Positioning window	UDINT	121.5.0.0	Positioning general parameters
0675	Positioning window time	UINT	121.6.0.0	Positioning general parameters
0676	Feedrate override	UINT	121.7.0.0	Positioning general parameters
0677	Stop Delay	UDINT	121.8.0.0	Positioning general parameters
0678	Positioning position actual value	UDINT	121.9.0.0	Positioning general parameters

B.1 List of P parameters

Sercos IDN P-0-	Name	Type	Controller P No.	Function block
0679	Speed limit	UDINT	121.11.0.0	Positioning general parameters
0680	Position actual value revolutions with overflows	UDINT	121.12.0.0	Positioning general parameters
0681	Input revolutions of load gear	UDINT	121.13.0.0	Positioning general parameters
0682	Output revolutions of load gear	UDINT	121.14.0.0	Positioning general parameters
0683	Modulo revolutions	UDINT	121.15.0.0	Positioning general parameters
0684	Rotation position resolution	UDINT	121.16.0.0	Positioning general parameters
0685	Modulo position actual value	UDINT	121.17.0.0	Positioning general parameters
0686	Status	DWORD	121.18.0.0	Positioning general parameters
0687	Speed actual value motor encoder	FLOAT	121.19.0.0	Positioning general parameters
0688	Coarse position window	UDINT	121.20.0.0	Positioning general parameters
0689	Command Move to positive stop	WORD	121.21.0.0	Positioning general parameters
0690	Status Move to positive stop	WORD	121.22.0.0	Positioning general parameters
0691	Mode Move to positive stop	WORD	121.23.0.0	Positioning general parameters
0692	Positive stop position	UINT	121.24.0.0	Positioning general parameters
0693	Monitoring window positive stop	UINT	121.25.0.0	Positioning general parameters
0694	Offset modulo position actual value	DINT	121.26.0.0	Positioning general parameters
0695	Set value mode	WORD	121.27.0.0	Positioning general parameters
0700	Configuration mode	DWORD	124.1.0.0	Touch probe
0701	Activation command	WORD	124.2.0.0	Touch probe
0702	Status	DWORD	124.3.0.0	Touch probe
0703	Status 2	DWORD	124.4.0.0	Touch probe
0704	Encoder 1 trigger digital input TP1 pos. edge revolutions	UDINT	124.5.0.0	Touch probe
0705	Encoder 1 trigger digital input TP1 pos. edge angle	UDINT	124.6.0.0	Touch probe
0706	Encoder 1 trigger digital input TP1 neg. edge revolutions	UDINT	124.7.0.0	Touch probe
0707	Encoder 1 trigger digital input TP1 neg. edge angle	UDINT	124.8.0.0	Touch probe
0708	Encoder 1 trigger digital input TP2 pos. edge revolutions	UDINT	124.9.0.0	Touch probe
0709	Encoder 1 trigger digital input TP2 pos. edge angle	UDINT	124.10.0.0	Touch probe
0710	Encoder 1 trigger digital input TP2 neg. edge revolutions	UDINT	124.11.0.0	Touch probe
0711	Encoder 1 trigger digital input TP2 neg. edge angle	UDINT	124.12.0.0	Touch probe
0712	Encoder 1 trigger zero pulse pos. edge revolutions	UDINT	124.13.0.0	Touch probe
0713	Encoder 1 trigger zero pulse pos. edge angle	UDINT	124.14.0.0	Touch probe
0714	Encoder 1 trigger zero pulse neg. edge revolutions	UDINT	124.15.0.0	Touch probe
0715	Encoder 1 trigger zero pulse neg. edge angle	UDINT	124.16.0.0	Touch probe
0716	Encoder 2 trigger digital input TP1 pos. edge revolutions	UDINT	124.17.0.0	Touch probe
0717	Encoder 2 trigger digital input TP1 pos. edge angle	UDINT	124.18.0.0	Touch probe
0718	Encoder 2 trigger digital input TP1 neg. edge revolutions	UDINT	124.19.0.0	Touch probe
0719	Encoder 2 trigger digital input TP1 neg. edge angle	UDINT	124.20.0.0	Touch probe
0720	Encoder 2 trigger digital input TP2 pos. edge revolutions	UDINT	124.21.0.0	Touch probe
0721	Encoder 2 trigger digital input TP2 pos. edge angle	UDINT	124.22.0.0	Touch probe
0722	Encoder 2 trigger digital input TP2 neg. edge revolutions	UDINT	124.23.0.0	Touch probe
0723	Encoder 2 trigger digital input TP2 neg. edge angle	UDINT	124.24.0.0	Touch probe
0724	Encoder 2 trigger zero pulse pos. edge revolutions	UDINT	124.25.0.0	Touch probe
0725	Encoder 2 trigger zero pulse pos. edge angle	UDINT	124.26.0.0	Touch probe
0726	Encoder 2 trigger zero pulse neg. edge revolutions	UDINT	124.27.0.0	Touch probe
0727	Encoder 2 trigger zero pulse neg. edge angle	UDINT	124.28.0.0	Touch probe
0740	Parameter Int16_1	INT	126.1.0.0	Application
0741	Parameter Int16_2	INT	126.2.0.0	Application
0742	Parameter Int16_3	INT	126.3.0.0	Application

Sercos IDN P-0-	Name	Type	Controller P No.	Function block
0743	Parameter Int16_4	INT	126.4.0.0	Application
0744	Parameter Int16_5	INT	126.5.0.0	Application
0745	Parameter Uint16_1	UINT	126.21.0.0	Application
0746	Parameter Uint16_2	UINT	126.22.0.0	Application
0747	Parameter Uint16_3	UINT	126.23.0.0	Application
0748	Parameter Uint16_4	UINT	126.24.0.0	Application
0749	Parameter Uint16_5	UINT	126.25.0.0	Application
0750	Parameter Int32_1	DINT	126.41.0.0	Application
0751	Parameter Int32_2	DINT	126.42.0.0	Application
0752	Parameter Int32_3	DINT	126.43.0.0	Application
0753	Parameter Int32_4	DINT	126.44.0.0	Application
0754	Parameter Int32_5	DINT	126.45.0.0	Application
0755	Parameter Uint32_1	UDINT	126.61.0.0	Application
0756	Parameter Uint32_2	UDINT	126.62.0.0	Application
0757	Parameter Uint32_3	UDINT	126.63.0.0	Application
0758	Parameter Uint32_4	UDINT	126.64.0.0	Application
0759	Parameter Uint32_5	UDINT	126.65.0.0	Application
0760	Parameter Float_1	FLOAT	126.81.0.0	Application
0761	Parameter Float_2	FLOAT	126.82.0.0	Application
0762	Parameter Float_3	FLOAT	126.83.0.0	Application
0763	Parameter Float_4	FLOAT	126.84.0.0	Application
0764	Parameter Float_5	FLOAT	126.85.0.0	Application
0770	Status	INT16	101.1.0.0	Ring buffer
0771	Command	INT16	101.2.0.0	Ring buffer
0772	Channel 0 source parameter Id	UDINT	101.3.0.0	Ring buffer
0773	Channel 1 source parameter Id	UDINT	101.4.0.0	Ring buffer
0774	Channel 2 source parameter Id	UDINT	101.5.0.0	Ring buffer
0775	Channel 3 source parameter Id	UDINT	101.6.0.0	Ring buffer
0776	Channel 4 source parameter Id	UDINT	101.7.0.0	Ring buffer
0777	Channel 5 source parameter Id	UDINT	101.8.0.0	Ring buffer
0778	Channel 6 source parameter Id	UDINT	101.9.0.0	Ring buffer
0779	Channel 7 source parameter Id	UDINT	101.10.0.0	Ring buffer
0780	Trigger source parameter Id	UDINT	101.11.0.0	Ring buffer
0781	Trigger mode	UDINT	101.12.0.0	Ring buffer
0782	Trigger axis mask	UINT	101.13.0.0	Ring buffer
0783	Trigger condition	UDINT	101.14.0.0	Ring buffer
0784	Trigger compare value	FLOAT	101.15.0.0	Ring buffer
0785	Trigger compare mask	UDINT	101.16.0.0	Ring buffer
0786	Trigger cause	UINT	101.17.0.0	Ring buffer
0787	Sample time	FLOAT	101.18.0.0	Ring buffer
0788	After run time	FLOAT	101.19.0.0	Ring buffer
0789	Recording time	FLOAT	101.20.0.0	Ring buffer
0790	Buffer size	UDINT	101.21.0.0	Ring buffer
0791	Measure time	FLOAT	101.22.0.0	Ring buffer
0792	Task number	UINT	101.24.0.0	Ring buffer
0793	Sample count	UDINT	101.25.0.0	Ring buffer
0794	Count of sample to read	UDINT	101.26.0.0	Ring buffer
0800	Init. pos. detection method	INT	127.1.0.0	Find notch position

B.1 List of P parameters

Sercos IDN P-0-	Name	Type	Controller P No.	Function block
0801	Max. current notch position	FLOAT	127.4.0.0	Find notch position
0802	Current rise	FLOAT	127.5.0.0	Find notch position
0803	Current drop	FLOAT	127.6.0.0	Find notch position
0804	Duration constant current	FLOAT	127.7.0.0	Find notch position
0805	Encoder Offset el.	UINT	127.8.0.0	Find notch position
0806	Maximum angle	UINT	127.9.0.0	Find notch position
0807	Angle rising	UINT	127.10.0.0	Find notch position
0808	Error limit mech. delta angle	UINT	127.11.0.0	Find notch position
0809	Averaging zero speed detection	UINT	127.12.0.0	Find notch position
0810	Actual value mech. delta angle	INT	127.13.0.0	Find notch position
0820	Motor temperature status	UINT	128.1.0.0	Motor temperature
0821	Temperature acquisition system	UINT	128.2.0.0	Motor temperature
0822	Motor temperature	DINT	128.3.0.0	Motor temperature
0823	Warning threshold 1	UINT	128.4.0.0	Motor temperature
0824	Warning threshold 2	UINT	128.5.0.0	Motor temperature
0825	Motor temperature hysteresis	INT	128.7.0.0	Motor temperature
0831	Version	UINT	107.1.0.0	Motor type plate
0832	Type	STRING	107.2.0.0	Motor type plate
0833	Article number	UDINT	107.3.0.0	Motor type plate
0834	Serial number	UDINT	107.4.0.0	Motor type plate
0835	Nominal operation mode	UINT	107.5.0.0	Motor type plate
0836	Nominal power	FLOAT	107.6.0.0	Motor type plate
0837	Nominal speed	UINT	107.7.0.0	Motor type plate
0838	Nominal voltage	FLOAT	107.8.0.0	Motor type plate
0839	Nominal current	FLOAT	107.9.0.0	Motor type plate
0840	Standstill current	FLOAT	107.10.0.0	Motor type plate
0841	Standstill torque	FLOAT	107.11.0.0	Motor type plate
0842	Power factor	FLOAT	107.12.0.0	Motor type plate
0843	Nominal frequency	FLOAT	107.13.0.0	Motor type plate
0844	Magnetic current	FLOAT	107.14.0.0	Motor type plate
0845	Slip frequency cold	FLOAT	107.15.0.0	Motor type plate
0846	Slip frequency warm	FLOAT	107.16.0.0	Motor type plate
0847	Slip temperature cold	UINT	107.17.0.0	Motor type plate
0848	Slip temperature warm	UINT	107.18.0.0	Motor type plate
0849	Pole pairs	UINT	107.19.0.0	Motor type plate
0850	Ke factor	FLOAT	107.20.0.0	Motor type plate
0851	Max current	FLOAT	107.21.0.0	Motor type plate
0852	Peak torque	FLOAT	107.22.0.0	Motor type plate
0853	Friction moment	FLOAT	107.23.0.0	Motor type plate
0854	Attenuation factor	FLOAT	107.24.0.0	Motor type plate
0855	Max speed electr.	UINT	107.25.0.0	Motor type plate
0856	Max speed mech.	UINT	107.26.0.0	Motor type plate
0857	Max temperature	UINT	107.27.0.0	Motor type plate
0858	Time constant i2t	UINT	107.28.0.0	Motor type plate
0859	Stator resistance	FLOAT	107.29.0.0	Motor type plate
0860	Stator leakage inductance	FLOAT	107.30.0.0	Motor type plate
0861	Rotor resistance	FLOAT	107.31.0.0	Motor type plate
0862	Rotor leakage inductance	FLOAT	107.32.0.0	Motor type plate

Sercos IDN P-0-	Name	Type	Controller P No.	Function block
0863	Magnetizing inductance	FLOAT	107.33.0.0	Motor type plate
0864	Inductance Lq	FLOAT	107.34.0.0	Motor type plate
0865	Inductance Ld	FLOAT	107.35.0.0	Motor type plate
0866	Inertia of motor	FLOAT	107.36.0.0	Motor type plate
0867	Temperature sensor type	UINT	107.37.0.0	Motor type plate
0868	Motor flags	UINT	107.38.0.0	Motor type plate
0869	Encoder gear gain	UINT	107.39.0.0	Motor type plate
0870	Brake nominal voltage	FLOAT	107.40.0.0	Motor type plate
0871	Brake torque	FLOAT	107.41.0.0	Motor type plate
0872	Inertia of brake	FLOAT	107.42.0.0	Motor type plate
0873	Nominal torque	FLOAT	107.43.0.0	Motor type plate
0874	Nominal Kt	FLOAT	107.44.0.0	Motor type plate
0875	Motor primary part	STRING	107.60.0.0	Motor type plate
0876	Max. feed force	UDINT	107.61.0.0	Motor type plate
0877	Nominal feed force	UDINT	107.62.0.0	Motor type plate
0878	Nominal speed	FLOAT	107.63.0.0	Motor type plate
0879	Voltage constant	FLOAT	107.64.0.0	Motor type plate
0880	Weight	FLOAT	107.65.0.0	Motor type plate
0881	Motor secondary part	STRING	107.66.0.0	Motor type plate
0882	Pole pitch	UDINT	107.67.0.0	Motor type plate
0900	Hardware id	STRING	129.3.0.0	Power unit characteristic data
0901	Hardware name	STRING	129.4.0.0	Power unit characteristic data
0902	Nominal current 2 kHz	FLOAT	129.12.0.0	Power unit characteristic data
0903	Nominal current 4 kHz	FLOAT	129.13.0.0	Power unit characteristic data
0904	Nominal current 8 kHz	FLOAT	129.14.0.0	Power unit characteristic data
0905	Nominal current 16 kHz	FLOAT	129.15.0.0	Power unit characteristic data
0906	Peak current 2 kHz	FLOAT	129.16.0.0	Power unit characteristic data
0907	Peak current 4 kHz	FLOAT	129.17.0.0	Power unit characteristic data
0908	Peak current 8 kHz	FLOAT	129.18.0.0	Power unit characteristic data
0909	Peak current 16 kHz	FLOAT	129.19.0.0	Power unit characteristic data
0910	Overcurrent threshold	FLOAT	129.20.0.0	Power unit characteristic data
0911	Max. DC-link voltage	FLOAT	129.21.0.0	Power unit characteristic data
0912	Max peak current time	UINT	129.22.0.0	Power unit characteristic data
0913	Time phase error	UINT	129.24.0.0	Power unit characteristic data
0914	Max heat sink temperature	UINT	129.26.0.0	Power unit characteristic data
0915	Max ambient temperature	UINT	129.27.0.0	Power unit characteristic data
0916	Firmware Version	UINT	129.44.0.0	Power unit characteristic data
0917	Power factor	UINT	129.45.0.0	Power unit characteristic data
0918	PU serial number	UDINT	129.46.0.0	Power unit characteristic data
0919	Amp type code	STRING	129.47.0.0	Power unit characteristic data
0920	Data configuration	UINT	129.48.0.0	Power unit characteristic data
0921	Amp article number	UDINT	129.49.0.0	Power unit characteristic data
0922	Ixt current limit threshold	FLOAT	129.60.0.0	Power unit characteristic data
0923	Power supply mode	UNINT	130.10.0.0	Power unit
0924	I offset phase U	FLOAT	130.18.0.0	Power unit
0925	I offset phase V	FLOAT	130.19.0.0	Power unit
0926	I offset phase W	FLOAT	130.20.0.0	Power unit
0927	Warning mask	UINT	130.23.0.0	Power unit

B.1 List of P parameters

Sercos IDN P-0-	Name	Type	Controller P No.	Function block
0928	DSP timeout counter	UINT	130.26.0.0	Power unit
0929	Actual value ground current	FLOAT	130.28.0.0	Power unit
0930	Heat sink temperature	FLOAT	130.1.0.0	Power unit
0931	Ambient temperature	FLOAT	130.2.0.0	Power unit
0932	DC Link voltage	FLOAT	130.3.0.0	Power unit
0933	Mains voltage	FLOAT	130.8.0.0	Power unit
0934	Fan mode	UINT	130.9.0.0	Power unit
0935	Heatsink temperature warning threshold	UINT	130.12.0.0	Power unit
0936	Interior temperature warning threshold	UINT	130.13.0.0	Power unit
0937	PWM frequency	UINT	130.15.0.0	Power unit
0938	Phase error delay time	UINT	130.24.0.0	Power unit
0939	Mains failure delay	UINT	130.25.0.0	Power unit
0940	Actual ground fault current	FLOAT	130.28.0.0	Power unit
0941	Chopper threshold	FLOAT	130.29.0.0	Power unit
0942	Status STO module	UINT	130.34.0.0	Power unit
0943	Mode power failure monitoring	UINT	130.35.0.0	Power unit
0944	Relative Udc threshold power failure	FLOAT	130.36.0.0	Power unit
0945	Udc threshold power failure	FLOAT	130.37.0.0	Power unit
0946	Udc hysteresis power failure	FLOAT	130.38.0.0	Power unit
0947	Udc auto detect	FLOAT	130.39.0.0	Power unit
0948	Operation time	UINT	130.40.0.0	Power unit
0949	Active PWM frequency	UINT	130.41.0.0	Power unit
0950	Number of pulses	UDINT	137.1.0.0	Encoder type plate
0951	Number of revolutions	UINT	137.2.0.0	Encoder type plate
0952	Encoder data selection	UINT	137.3.0.0	Encoder type plate
0953	Notch position offset	UINT	137.4.0.0	Encoder type plate
0954	M0 offset angle	UDINT	137.5.0.0	Encoder type plate
0955	M0 offset revolution	UDINT	137.6.0.0	Encoder type plate
0956	M0sector position initiator	DINT	137.7.0.0	Encoder type plate
0957	Type name	STRING	137.20.0.0	Encoder type plate
0958	Dig. resolution	UINT	137.28.0.0	Encoder type plate
0959	Resolution speed	UINT	137.31.0.0	Encoder type plate
0960	Angle resolution	UINT	137.32.0.0	Encoder type plate
0961	Signal length	UDINT	137.33.0.0	Encoder type plate
0962	Measure step	UDINT	137.34.0.0	Encoder type plate
0970	Encoder type	INT	106.1.0.0	Encoder
0971	Status	UINT	106.2.0.0	Encoder
0972	Encoder options	UDINT	106.3.0.0	Encoder
0973	Encoder actual angle	UDINT	106.5.0.0	Encoder
0974	Encoder actual revolutions	UDINT	106.6.0.0	Encoder
0975	Speed	DINT	106.7.0.0	Encoder
0976	Time constant speed display	FLOAT	106.8.0.0	Encoder
0977	Speed filtered	FLOAT	106.9.0.0	Encoder
0978	Position actual angle 32 bit	UDINT	106.10.0.0	Encoder
0979	Position actual revolutions	UDINT	106.11.0.0	Encoder
0980	Position actual value	UDINT	106.12.0.0	Encoder
0981	Motor angle	UDINT	106.13.0.0	Encoder
0982	Revolution overflow counter	DINT	106.15.0.0	Encoder

Sercos IDN P-0-	Name	Type	Controller P No.	Function block
0983	Revolution overflow counter max value	DINT	106.16.0.0	Encoder
0984	Pitch linear measurement system	UDINT	106.28.0.0	Encoder
0985	SSI mode	UDINT	106.60.0.0	Encoder
0986	SSI status	UDINT	106.61.0.0	Encoder
0987	SSI bits angle	UINT	106.62.0.0	Encoder
0988	SSI bits revolutions	UINT	106.63.0.0	Encoder
0989	SSI angle	UDINT	106.64.0.0	Encoder
0990	SSI revolutions	UDINT	106.65.0.0	Encoder
0991	EnDat clock frequency	UINT	106.73.0.0	Encoder
0992	Oversampling factor	UINT	106.4.0.0	Encoder
0993	Resolver mode	UINT	106.43.0.0	Encoder
1000	Mode	WORD	131.1.0.0	Fieldbus
1001	State	WORD	131.2.0.0	Fieldbus
1002	Last producer index	UINT	131.7.0.0	Fieldbus
1003	Last consumer index	UINT	131.8.0.0	Fieldbus
1004	Slave settings	UDINT	131.9.0.0	Fieldbus
1005	Slave info	UDINT	131.10.0.0	Fieldbus
1006	MAC address	STRING	131.11.0.0	Fieldbus
1007	Base Ip address	UDINT	131.12.0.0	Fieldbus
1008	DIP switch settings	UDINT	131.13.0.0	Fieldbus
1009	Software IP address	UDINT	131.14.0.0	Fieldbus
1010	Actual IP address	UDINT	131.15.0.0	Fieldbus
1011	Gateway	UDINT	131.16.0.0	Fieldbus
1012	Subnet mask	UDINT	131.17.0.0	Fieldbus
1013	Fieldbus cycle time	UDINT	131.18.0.0	Fieldbus
1014	Slave error code	UDINT	131.19.0.0	Fieldbus
1015	Division ratio cyclic task	UINT	131.20.0.0	Fieldbus
1016	Configuration profile 1	UDINT	131.21.0.0	Fieldbus
1017	Error counter cyclic actual values	UDINT	131.52.0.0	Fieldbus
1018	Error counter cyclic set values	UDINT	131.53.0.0	Fieldbus
1019	Fieldbus type	UINT	131.22.0.0	Fieldbus
1020	Options	UDINT	131.23.0.0	Fieldbus
1021	Error threshold cyclic actual values	UDINT	131.55.0.0	Fieldbus
1022	Error threshold cyclic set values	UDINT	131.56.0.0	Fieldbus
1030	Mode	UINT	156.1.0.0	Synchronization
1031	Status	WORD	156.2.0.0	Synchronization
1032	Sync tolerance	UINT	156.3.0.0	Synchronization
1033	Sync offset	DINT	156.4.0.0	Synchronization
1034	Fieldbus cycle	UDINT	156.5.0.0	Synchronization
1035	Fieldbus jitter	DINT	156.6.0.0	Synchronization
1036	Sync error	DINT	156.7.0.0	Synchronization
1037	Max. jitter positive	DINT	156.8.0.0	Synchronization
1038	Max. jitter negative	DINT	156.9.0.0	Synchronization
1039	Time fieldbus write access	DINT	156.15.0.0	Synchronization
1040	Time DSP read access	DINT	156.16.0.0	Synchronization
1041	Time DSP write access	DINT	156.17.0.0	Synchronization
1042	Time fieldbus read access	DINT	156.18.0.0	Synchronization
1043	Time fieldbus read to DSP read	DINT	156.19.0.0	Synchronization

B.1 List of P parameters

Sercos IDN P-0-	Name	Type	Controller P No.	Function block
1100	Mode of Iq limit	UINT	138.1.0.0	Current limitation
1101	Iq limit motor/TD1	FLOAT	138.2.0.0	Current limitation
1102	Iq limit generator/TD2	FLOAT	138.3.0.0	Current limitation
1103	Iq limit quadrant hysteresis	FLOAT	138.4.0.0	Current limitation
1104	Motor quadrant	UINT	138.5.0.0	Current limitation
1105	Iq upper limit	FLOAT	138.6.0.0	Current limitation
1106	Iq lower limit	FLOAT	138.7.0.0	Current limitation
1107	Bitbar of external current limit	UINT	138.8.0.0	Current limitation
1108	External limiting max current	FLOAT	138.9.0.0	Current limitation
1109	External limiting max field current	FLOAT	138.10.0.0	Current limitation
1110	Iq set value before notch filter	FLOAT	138.11.0.0	Current limitation
1111	Center frequency Iq set value notch filter	FLOAT	138.12.0.0	Current limitation
1112	Bandwidth Iq set value notch filter	FLOAT	138.13.0.0	Current limitation
1113	Iq cyclic bipolar limit	UINT	138.14.0.0	Current limitation
1114	Iq limit motor symmetric	FLOAT	138.15.0.0	Current limitation
1115	Speed threshold for breakdown torque	FLOAT	138.16.0.0	Current limitation
1116	Factor for breakdown torque	FLOAT	138.17.0.0	Current limitation
1117	Iq max for breakdown torque	FLOAT	138.18.0.0	Current limitation
1118	Max. available torque	UDINT	138.20.0.0	Current limitation
1119	Torque display	DINT	138.21.0.0	Current limitation
1120	Torque limit symmetric	UDINT	138.22.0.0	Current limitation
1121	Kt correction factor	FLOAT	138.23.0.0	Current limitation
1122	Indication threshold torque	UDINT	138.24.0.0	Current limitation
1123	Status current limitation	UDINT	138.25.0.0	Current limitation
1126	Smoothing time torque display	FLOAT	138.29.0.0	Current limitation
1140	Status	WORD	143.1.0.0	Monitoring
1141	Mode 1	UINT	143.2.0.0	Monitoring
1142	Position error limit 1	UDINT	143.3.0.0	Monitoring
1143	Position error monitoring time 1	UINT	143.4.0.0	Monitoring
1144	Mode 2	UINT	143.5.0.0	Monitoring
1145	Position error limit 2	UDINT	143.6.0.0	Monitoring
1146	Position error monitoring time 2	UINT	143.7.0.0	Monitoring
1147	Field angle speed threshold	UINT	143.8.0.0	Monitoring
1148	Field angle counter	UINT	143.9.0.0	Monitoring
1160	Field weakening mode	UINT	142.1.0.0	Field weakening
1161	Field weakening factor	FLOAT	142.2.0.0	Field weakening
1162	P-gain field weakening controller	FLOAT	142.3.0.0	Field weakening
1163	Field weakening controller integral action time	FLOAT	142.4.0.0	Field weakening
1164	Minimum field weak factor	FLOAT	142.5.0.0	Field weakening
1165	Maximum output voltage RMS	FLOAT	142.6.0.0	Field weakening
1166	Actual filtered output voltage RMS	FLOAT	142.7.0.0	Field weakening
1167	Voltage threshold for field weakening	FLOAT	142.8.0.0	Field weakening
1168	Speed threshold for field weakening	FLOAT	142.9.0.0	Field weakening
1169	Field controller due to speed	FLOAT	142.12.0.0	Field weakening
1170	Field weakening controller output	FLOAT	142.13.0.0	Field weakening
1171	Status field weakening	UINT	142.14.0.0	Field weakening
1172	Factor field weakening threshold	FLOAT	142.15.0.0	Field weakening
1173	P gain breakdown torque controller	FLOAT	142.19.0.0	Field weakening

Sercos IDN P-0-	Name	Type	Controller P No.	Function block
1174	Breakdown torque controller integral action time	FLOAT	142.20.0.0	Field weakening
1175	Factor breakdown torque threshold	FLOAT	142.21.0.0	Field weakening
1176	Breakdown torque controller output	FLOAT	142.22.0.0	Field weakening
1200	Mode error display	UDINT	135.1.0.0	Display
1210	Password	UINT	139.1.0.0	System
1211	Baudrate	UDINT	139.2.0.0	System
1213	Number of axes	UDINT	139.4.0.0	System
1214	System command	UDINT	139.23.0.0	System
1215	Switch on time	UDINT	139.25.0.0	System
1220	Mode	WORD	140.1.0.0	Signal bus
1221	Status	WORD	140.2.0.0	Signal bus
1230	Mode	DWORD	134.1.0.0	Brake
1231	Status	DWORD	134.2.0.0	Brake
1232	Control automatic	DWORD	134.3.0.0	Brake
1233	Command	WORD	134.4.0.0	Brake
1234	Torque limit	FLOAT	134.5.0.0	Brake
1235	Speed limit	FLOAT	134.6.0.0	Brake
1236	Timeout check-back signal	UINT	134.7.0.0	Brake
1237	Pulse inhibit delay	UINT	134.8.0.0	Brake
1238	Start of motion delay	UINT	134.9.0.0	Brake
1239	Opening delay	UINT	134.10.0.0	Brake
1300	Mode asynchronous machine	UINT	146.1.0.0	Asynchronous machine
1301	Injection frequency AM	FLOAT	146.2.0.0	Asynchronous machine
1302	Injection amplitude AM	FLOAT	146.3.0.0	Asynchronous machine
1303	Injection AM bandwidth	FLOAT	146.4.0.0	Asynchronous machine
1304	Time constant compensation controller	FLOAT	146.5.0.0	Asynchronous machine
1305	Id set value additive	FLOAT	146.6.0.0	Asynchronous machine
1306	Speed threshold direct field orientation on/off	FLOAT	146.7.0.0	Asynchronous machine
1307	Status motor model	UINT	146.8.0.0	Asynchronous machine
1308	Kp flux controller	FLOAT	146.10.0.0	Asynchronous machine
1309	Tn flux controller	FLOAT	146.11.0.0	Asynchronous machine
1310	Limitation magnetizing current	FLOAT	146.12.0.0	Asynchronous machine
1311	Flux set value	FLOAT	146.13.0.0	Asynchronous machine
1312	Flux actual value	FLOAT	146.14.0.0	Asynchronous machine
1313	Active magnetizing current	FLOAT	146.15.0.0	Asynchronous machine
1314	Slip	DINT	146.16.0.0	Asynchronous machine
1315	Status Lh identification	UINT	146.17.0.0	Asynchronous machine
1316	I part flux controller	FLOAT	146.18.0.0	Asynchronous machine
1350	Mode	UDINT	147.1.0.0	Torque coupling
1351	Status master	UINT	147.2.0.0	Torque coupling
1352	Status slave	UINT	147.3.0.0	Torque coupling
1353	Coupling command master	UINT	147.4.0.0	Torque coupling
1354	Torque coupling factor master	FLOAT	147.5.0.0	Torque coupling
1355	Torque coupling factor slave	FLOAT	147.6.0.0	Torque coupling
1356	Compensating controller P-gain	FLOAT	147.7.0.0	Torque coupling
1357	Compensating controller integral action time	FLOAT	147.8.0.0	Torque coupling
1358	Compensating controller output upper limit	FLOAT	147.9.0.0	Torque coupling
1359	Compensating controller output lower limit	FLOAT	147.10.0.0	Torque coupling

B.1 List of P parameters

Sercos IDN P-0-	Name	Type	Controller P No.	Function block
1360	Compensating controller set value	FLOAT	147.11.0.0	Torque coupling
1361	Compensating controller actual value	FLOAT	147.12.0.0	Torque coupling
1362	Compensating controller output	FLOAT	147.13.0.0	Torque coupling
1363	Compensating controller integral term	FLOAT	147.14.0.0	Torque coupling
1364	Torque init stress 0	FLOAT	147.15.0.0	Torque coupling
1365	Torque init stress 1	FLOAT	147.16.0.0	Torque coupling
1366	Speed limit torque init stress 1	FLOAT	147.17.0.0	Torque coupling
1367	Torque init stress pt1 time constant	FLOAT	147.18.0.0	Torque coupling
1368	Torque set value master	DINT	147.19.0.0	Torque coupling
1369	Torque init stress actual value	FLOAT	147.20.0.0	Torque coupling
1370	Torque init stress actual value master	DINT	147.21.0.0	Torque coupling
1380	Mode	DWORD	148.1.0.0	Return motion
1381	Status	UDINT	148.2.0.0	Return motion
1382	Target position	UDINT	148.3.0.0	Return motion
1383	Speed limit	UDINT	148.4.0.0	Return motion
1384	Acceleration limit	UDINT	148.5.0.0	Return motion
1385	Position error limit	UDINT	148.6.0.0	Return motion
1386	Position error time	UINT	148.7.0.0	Return motion
1387	Output position set value	UDINT	148.8.0.0	Return motion
1388	Output speed set value	DINT	148.9.0.0	Return motion
1389	Output acceleration set value	DINT	148.10.0.0	Return motion
1400	Mode PID controller 1	WORD	150.1.0.0	PID controller
1401	Status PID controller 1	WORD	150.2.0.0	PID controller
1402	Axis index PID controller 1	UINT	150.3.0.0	PID controller
1403	Source number set value PID controller 1	UDINT	150.4.0.0	PID controller
1404	Source number actual value PID controller 1	UDINT	150.5.0.0	PID controller
1405	Target number output PID controller 1	UDINT	150.6.0.0	PID controller
1406	P-gain PID controller 1	FLOAT	150.7.0.0	PID controller
1407	Integral action time PID controller 1	FLOAT	150.8.0.0	PID controller
1408	Derivative time PID controller 1	FLOAT	150.9.0.0	PID controller
1409	Pt1 time constant PID controller 1	FLOAT	150.10.0.0	PID controller
1410	Output upper limit PID controller 1	FLOAT	150.11.0.0	PID controller
1411	Output lower limit PID controller 1	FLOAT	150.12.0.0	PID controller
1412	Set value PID controller 1	FLOAT	150.13.0.0	PID controller
1413	Actual value PID controller 1	FLOAT	150.14.0.0	PID controller
1414	Output PID controller 1	FLOAT	150.15.0.0	PID controller
1415	Integral term PID controller 1	FLOAT	150.16.0.0	PID controller
1416	Mode PID controller 2	WORD	150.17.0.0	PID controller
1417	Status PID controller 2	WORD	150.18.0.0	PID controller
1418	Axis index PID controller 2	UINT	150.19.0.0	PID controller
1419	Source number set value PID controller 2	UDINT	150.20.0.0	PID controller
1420	Source number actual value PID controller 2	UDINT	150.21.0.0	PID controller
1421	Target number output PID controller 2	UDINT	150.22.0.0	PID controller
1422	P-gain PID controller 2	FLOAT	150.23.0.0	PID controller
1423	Integral action time PID controller 2	FLOAT	150.24.0.0	PID controller
1424	Derivative time PID controller 2	FLOAT	150.25.0.0	PID controller
1425	Pt1 time constant PID controller 2	FLOAT	150.26.0.0	PID controller
1426	Output upper limit PID controller 2	FLOAT	150.27.0.0	PID controller

Sercos IDN P-0-	Name	Type	Controller P No.	Function block
1427	Output lower limit PID controller 2	FLOAT	150.28.0.0	PID controller
1428	Set value PID controller 2	FLOAT	150.29.0.0	PID controller
1429	Actual value PID controller 2	FLOAT	150.30.0.0	PID controller
1430	Output PID controller 2	FLOAT	150.31.0.0	PID controller
1431	Integral term PID controller 2	FLOAT	150.32.0.0	PID controller
1440	Mode	WORD	151.1.0.0	Two level controller absolute
1441	Status	WORD	151.2.0.0	Two level controller absolute
1442	Input	UDINT	151.3.0.0	Two level controller absolute
1443	Lower threshold absolute	FLOAT	151.5.0.0	Two level controller absolute
1444	Upper threshold absolute	FLOAT	151.6.0.0	Two level controller absolute
1445	Axis selection output parameter	UINT	151.9.0.0	Two level controller absolute
1446	Target number	UDINT	151.10.0.0	Two level controller absolute
1447	Bit selection	DWORD	151.11.0.0	Two level controller absolute
1448	Bit pattern LOW	DWORD	151.12.0.0	Two level controller absolute
1449	Bit pattern HIGH	DWORD	151.13.0.0	Two level controller absolute
1450	Lower threshold absolute UDINT	UDINT	151.14.0.0	Two level controller absolute
1451	Upper threshold absolute UDINT	UDINT	151.15.0.0	Two level controller absolute
1455	Mode	WORD	152.1.0.0	Two level controller relative
1456	Status	WORD	152.2.0.0	Two level controller relative
1457	Input	UDINT	152.3.0.0	Two level controller relative
1458	Relative compare value	UDINT	152.4.0.0	Two level controller relative
1459	Lower threshold absolute	FLOAT	152.5.0.0	Two level controller relative
1460	Upper threshold absolute	FLOAT	152.6.0.0	Two level controller relative
1461	Lower threshold relative	FLOAT	152.7.0.0	Two level controller relative
1462	Upper threshold relative	FLOAT	152.8.0.0	Two level controller relative
1463	Axis selection output parameter	UINT	152.9.0.0	Two level controller relative
1464	Target number	UDINT	152.10.0.0	Two level controller relative
1465	Bit selection	DWORD	152.11.0.0	Two level controller relative
1466	Bit pattern LOW	DWORD	152.12.0.0	Two level controller relative
1467	Bit pattern HIGH	DWORD	152.13.0.0	Two level controller relative
1468	Lower threshold absolute UDINT	UDINT	152.14.0.0	Two level controller relative
1469	Upper threshold absolute UDINT	UDINT	152.15.0.0	Two level controller relative
1470	Lower threshold relative UDINT	UDINT	152.16.0.0	Two level controller relative
1471	Upper threshold relative UDINT	UDINT	152.17.0.0	Two level controller relative
1480	mode	DWORD	165.1.0.0	Configurable status
1481	Configurable status	DWORD	165.2.0.0	Configurable status
1482	Latch	DWORD	165.6.0.0	Configurable status
1490	Status	WORD	168.1.0.0	Motor potentiometer
1491	Mode	WORD	168.2.0.0	Motor potentiometer
1492	Output	INT	168.3.0.0	Motor potentiometer
1493	Upper limit	INT	168.4.0.0	Motor potentiometer
1494	Lower limit	INT	168.5.0.0	Motor potentiometer
1495	Increment	INT	168.6.0.0	Motor potentiometer
1500	DC link controller set value	FLOAT	114.1.0.0	Udc controller
1501	P-gain of DC link controller	FLOAT	114.2.0.0	Udc controller
1502	Tn of DC link controller	FLOAT	114.3.0.0	Udc controller
1503	DC link controller output	FLOAT	114.4.0.0	Udc controller
1504	Current positive limit	FLOAT	114.5.0.0	Udc controller

B.1 List of P parameters

Sercos IDN P-0-	Name	Type	Controller P No.	Function block
1505	Current negative limit	FLOAT	114.6.0.0	Udc controller
1506	DC link hysteresis	FLOAT	114.9.0.0	Udc controller
1507	Factor maximum voltage for Id brake	FLOAT	114.10.0.0	Udc controller
1510	Mode	WORD	154.1.0.0	Compensation friction torque
1511	Lower speed threshold	FLOAT	154.3.0.0	Compensation friction torque
1512	Upper speed threshold	FLOAT	154.4.0.0	Compensation friction torque
1513	Output value 1	FLOAT	154.5.0.0	Compensation friction torque
1514	Output value 2	FLOAT	154.6.0.0	Compensation friction torque
1515	Output value 3	FLOAT	154.7.0.0	Compensation friction torque
1516	Friction compensation actual output value	FLOAT	154.8.0.0	Compensation friction torque
1517	Hysteresis speed threshold	FLOAT	154.9.0.0	Compensation friction torque
1520	Mode	UINT	155.1.0.0	Controller adaption
1521	State	UINT	155.2.0.0	Controller adaption
1522	Lower adaption threshold for speed controller	FLOAT	155.3.0.0	Controller adaption
1523	Upper adaption threshold for speed controller	FLOAT	155.4.0.0	Controller adaption
1524	Factor Kp adaption	FLOAT	155.5.0.0	Controller adaption
1525	Factor Tn adaption	FLOAT	155.6.0.0	Controller adaption
1526	Actual Kp speed controller	FLOAT	155.7.0.0	Controller adaption
1527	Actual Tn speed controller	FLOAT	155.8.0.0	Controller adaption
1528	Actual Ki speed controller	FLOAT	155.9.0.0	Controller adaption
1529	Actual Ks factor	FLOAT	155.10.0.0	Controller adaption
1530	Low adaption threshold for current controller	FLOAT	155.11.0.0	Controller adaption
1531	High adaption threshold for current controller	FLOAT	155.12.0.0	Controller adaption
1532	Kp current controller adaption	FLOAT	155.13.0.0	Controller adaption
1533	Ks adaption	UDINT	155.14.0.0	Controller adaption
1534	Average adaption limit for speed controller	FLOAT	155.15.0.0	Controller adaption
1540	Mode	UDINT	169.1.0.0	Gantry
1541	Status	UDINT	169.2.0.0	Gantry
1542	Position deviation threshold	UDINT	169.3.0.0	Gantry
1543	Position deviation time	UINT	169.4.0.0	Gantry
1544	Position deviation actual value	UINT	169.5.0.0	Gantry
1545	Current deviation threshold	FLOAT	169.6.0.0	Gantry
1546	Current deviation time	UINT	169.7.0.0	Gantry
1547	Current deviation actual value	FLOAT	169.8.0.0	Gantry
1555	Mode block 1	DWORD	172.1.0.0	Incremental encoder emulation
1556	Status block 1	DWORD	172.2.0.0	Incremental encoder emulation
1557	No. of pulses block 1	UDINT	172.3.0.0	Incremental encoder emulation
1558	Zero pulse offset block 1	UDINT	172.4.0.0	Incremental encoder emulation
1559	Fieldbus set value block 1	UDINT	172.5.0.0	Incremental encoder emulation
1560	Mode block 2	DWORD	172.10.0.0	Incremental encoder emulation
1561	Status block 2	DWORD	172.11.0.0	Incremental encoder emulation
1562	No. of pulses block 2	UDINT	172.12.0.0	Incremental encoder emulation
1563	Zero pulse offset block 2	UDINT	172.13.0.0	Incremental encoder emulation
1564	Fieldbus set value block 2	UDINT	172.14.0.0	Incremental encoder emulation
1570	Mode	DWORD	173.1.0.0	SSI encoder emulation
1571	Status	DWORD	173.2.0.0	SSI encoder emulation
1572	Fieldbus set value angle	UDINT	173.3.0.0	SSI encoder emulation
1573	Fieldbus set value revolutions	UDINT	173.4.0.0	SSI encoder emulation

Sercos IDN P-0-	Name	Type	Controller P No.	Function block
1580	Command	UINT	174.1.0.0	Option module type plate
1581	Status	UINT	174.2.0.0	Option module type plate
1582	Hardware board type	STRING	174.4.0.0	Option module type plate
1583	Option module type code	STRING	174.5.0.0	Option module type plate
1584	Hardware date	STRING	174.6.0.0	Option module type plate
1585	Hardware name	STRING	174.7.0.0	Option module type plate
1586	Serial No.	UDINT	174.8.0.0	Option module type plate
1587	Article No.	UDINT	174.9.0.0	Option module type plate
1590	Module version	UINT	200.1.0.0	AISM info (SAF module)
1591	Firmware version module	UINT	200.2.0.0	AISM info (SAF module)
1592	Hardware version module	UINT	200.3.0.0	AISM info (SAF module)
1593	Serial No.	UDINT	200.4.0.0	AISM info (SAF module)
1594	FSoE address	UINT	200.5.0.0	AISM info (SAF module)
1595	Safety level	UINT	200.6.0.0	AISM info (SAF module)
1596	Version of the parameter set	UINT	200.7.0.0	AISM info (SAF module)
1597	Last module version	UINT	200.8.0.0	AISM info (SAF module)
1598	Build No.	UDINT	200.9.0.0	AISM info (SAF module)
1599	Reset code	UDINT	200.10.0.0	AISM info (SAF module)
1605	Number of updates	UINT	201.1.0.0	AISM status (SAF module)
1606	Status inputs (physical I/O)	UDINT	201.2.0.0	AISM status (SAF module)
1607	Status outputs (physical I/O)	UDINT	201.3.0.0	AISM status (SAF module)
1608	Active FSoE activation mask axis 1	UINT	201.4.0.0	AISM status (SAF module)
1609	Active FSoE parameter switching axis 1	UINT	201.5.0.0	AISM status (SAF module)
1610	Status outputs (FSoE) axis 1	UINT	201.6.0.0	AISM status (SAF module)
1611	Active FSoE error status axis 1	UINT	201.7.0.0	AISM status (SAF module)
1612	Active FSoE activation mask axis 2	UINT	201.8.0.0	AISM status (SAF module)
1613	Active FSoE parameter switching axis 2	UINT	201.9.0.0	AISM status (SAF module)
1614	Status outputs (FSoE) axis 2	UINT	201.10.0.0	AISM status (SAF module)
1615	Active FSoE error status axis 2	UINT	201.11.0.0	AISM status (SAF module)
1616	Module status	UINT	201.12.0.0	AISM status (SAF module)
1617	Module status information	UINT	201.13.0.0	AISM status (SAF module)
1618	Number of entries in error file	UINT	201.15.0.0	AISM status (SAF module)
1619	Module error 1	UDINT	201.19.0.0	AISM status (SAF module)
1620	Module error 2	UDINT	201.20.0.0	AISM status (SAF module)
1621	Module error 3	UDINT	201.21.0.0	AISM status (SAF module)
1630	Mode PU temperature model	UINT	175.1.0.0	Power unit temperature model
1631	Status PU temperature model	UINT	175.2.0.0	Power unit temperature model
1632	Max. device control cabinet temperature	UINT	175.3.0.0	Power unit temperature model
1633	Max. device altitude	UINT	175.4.0.0	Power unit temperature model
1634	Max. device mains voltage	UINT	175.5.0.0	Power unit temperature model
1635	Max. device DC link voltage	UINT	175.6.0.0	Power unit temperature model
1636	PU max. continuous current actual value	FLOAT	175.7.0.0	Power unit temperature model
1637	PU I2t max. continuous current actual value	FLOAT	175.8.0.0	Power unit temperature model
1638	Power unit thermal load	FLOAT	175.15.0.0	Power unit temperature model
1650	Current setting	FLOAT	133.22.0.0	Injection
1660	Acceptance of parameters	DINT	123.10.0.0	Identification

B.2 List of S parameters

B.2 List of S parameters

Also see [►Structure of the parameters◄](#) on page 60.

Parameter	Range		Writable	Length	Scaling	b maXX	Standard	Page	
S-0-0001	Control unit cycle time (T_{Ncyc})	250 to 65000 μ s	-	-(CP3, CP4)	2 bytes	1:1	-	1000 μ s	61
S-0-0002	Communication cycle time (T_{Scyc})	250 to 8000 μ s	-	-(CP3, CP4)	2 bytes	1:1	P-0-1013	1000 μ s	61
S-0-0006	AT transmission starting time (T1)	T_{1min} to T_{Scyc}	-	-(CP3, CP4)	2 bytes	1:1	-	80 μ s	61
S-0-0007	Feedback acquisition capture point (T4)	0 to T_{Scyc}	-	-(CP3, CP4)	2 bytes	1:1	-	50 μ s	61
S-0-0008	Command value valid time (T3)	0 to T_{Scyc}	-	-(CP3, CP4)	2 bytes	1:1	-	510 μ s	61
S-0-0011	Class 1 diagnostic (C1D)	- to -	CR	-	2 bytes	-	-	0	62
S-0-0012	Class 2 diagnostic (C2D)	- to -	CR	-	2 bytes	-	-	0	63
S-0-0013	Class 3 diagnostic (C3D)	- to -	CR	-	2 bytes	-	-	0	64
S-0-0014	Interface status	- to -	-	-	2 bytes	-	-	0	66
S-0-0015	Telegram type	- to -	-	-(CP3, CP4)	2 bytes	-	-	3	67
S-0-0016	Configuration list of AT	- to -	-	-(CP3, CP4)	2 bytes, variable	-	-	*	67
S-0-0017	IDN list of all operation data	- to -	-	-	2 bytes, variable	-	-	-	67
S-0-0018	IDN list of operation data for CP2	- to -	-	-	2 bytes, variable	-	-	*	68
S-0-0019	IDN list of operation data for CP3	- to -	-	-	2 bytes, variable	-	-	*	68
S-0-0020	IDN list of operation data for CP4	- to -	-	-	2 bytes, variable	-	-	*	68
S-0-0021	IDN list of invalid operation data for CP2	- to -	-	-	2 bytes, variable	-	-	*	68
S-0-0022	IDN list of invalid operation data for CP3	- to -	-	-	2 bytes, variable	-	-	*	69
S-0-0023	IDN list of invalid operation data for CP4	- to -	-	-	2 bytes, variable	-	-	*	69
S-0-0024	Configuration list of MDT	- to -	-	-(CP3, CP4)	2 bytes, variable	-	-	*	69
S-0-0025	IDN list of all procedure commands	- to -	-	-	2 bytes, variable	-	-	*	69
S-0-0026	Configuration list signal statusword	- to -	-	-(CP3, CP4)	2 bytes, variable	-	-	*	70
S-0-0027	Configuration list signal controlword	- to -	-	-(CP3, CP4)	2 bytes, variable	-	-	*	70
S-0-0028	MST error counter	0 to 65535	-	-	2 bytes	1:1	-	0	70
S-0-0029	MDT error counter	0 to 65535	-	-	2 bytes	1:1	-	0	70
S-0-0030	Manufacturer version	- to -	-	-	2 bytes	-	-	b maXX SoE	71
S-0-0031	Hardware version	- to -	-	-	2 bytes	-	-	33.0000A	71
S-0-0032	Primary operation mode	- to -	-	-(CP4)	2 bytes	1:1	-	2	71
S-0-0033	Secondary operation mode 1	- to -	-	-(CP4)	2 bytes	1:1	-	2	71
S-0-0034	Secondary operation mode 2	- to -	-	-(CP4)	2 bytes	1:1	-	2	71
S-0-0035	Secondary operation mode 3	- to -	-	-(CP4)	2 bytes	1:1	-	2	71
S-0-0036	Velocity command value	-2^{31} to $+2^{31}-1$	CW, CR	x	4 bytes	G	P-0-0333	0	72
S-0-0037	Additive velocity command value	-2^{31} to $+2^{31}-1$	CW, CR	x	4 bytes	G	P-0-0078	0	72
S-0-0038	Positive velocity limit value	0 to $+2^{31}-1$	-	x	4 bytes	G	P-0-0081	0	72
S-0-0039	Negative velocity limit value	-2^{31} to 0	-	x	4 bytes	G	P-0-0082	0	72
S-0-0040	Velocity feedback value 1	-2^{31} to $+2^{31}-1$	CR	-	4 bytes	G	P-0-0052	0	73
S-0-0041	Homing velocity	-2^{31} to $+2^{31}-1$	CW	x	4 bytes	G	P-0-0644	0	73
S-0-0042	Homing acceleration	0 to $+2^{31}-1$	CW	x	4 bytes	B	P-0-0646, P-0-0647	0	73
S-0-0043	Velocity polarity parameter	- to -	-	-(CP4)	2 bytes	-	-	0	74
S-0-0044	Velocity data scaling type	- to -	-	-(CP4)	2 bytes	-	-	0xA	75

Parameter	Range		Writable	Length	Scaling	b maxX	Standard	Page	
S-0-0045	Velocity data scaling factor	1 to $2^{16}-1$	-	-(CP4)	2 bytes	-	1	75	
S-0-0046	Velocity data scaling exponent	-9 to 3	-	-(CP4)	2 bytes	-	-4	76	
S-0-0047	Position command value	-2^{31} to $2^{31}-1$	CW, CR	x	4 bytes	L	P-0-0514	0	76
S-0-0048	Additive position command value	-2^{31} to $2^{31}-1$	CW	x	4 bytes	L	-	0	76
S-0-0049	Position limit positive	-2^{31} to $2^{31}-1$	-	x	4 bytes	L	P-0-0673	0	76
S-0-0050	Position limit negative	-2^{31} to $2^{31}-1$	-	x	4 bytes	L	P-0-0672	0	77
S-0-0051	Position feedback value 1 (motor feedback)	-2^{31} to $2^{31}-1$	CR	-	4 bytes	L	P-0-0978, P-0-0979	0	77
S-0-0052	Reference distance 1	-2^{31} to $2^{31}-1$	-	x	4 bytes	L	P-0-0642	0	77
S-0-0053	Position feedback value 2 (external encoder)	-2^{31} to $2^{31}-1$	CR	-	4 bytes	L	-	0	77
S-0-0054	Reference distance 2	-2^{31} to $2^{31}-1$	-	x	4 bytes	L	P-0-0642	0	78
S-0-0055	Position polarity parameter	- to -	-	-(CP4)	2 bytes	-	-	0	78
S-0-0057	Position window	0 to $2^{31}-1$	-	x	4 bytes	L	P-0-0674	0	79
S-0-0058	Clearance	0 to $2^{31}-1$	-	x	4 bytes	L	-	0	79
S-0-0076	Position data scaling type	- to -	-	-(CP4)	2 bytes	-	-	0xA	80
S-0-0077	Linear position data scaling factor	1 to 65535	-	-(CP4)	2 bytes	-	-	1	80
S-0-0078	Linear position data scaling exponent	-9 to +3	-	-(CP4)	2 bytes	-	-	-7	81
S-0-0079	Rotational position resolution	0 to $2^{31}-1$	-	-(CP4)	4 bytes	-	P-0-0684	$36 \cdot 10^5$	81
S-0-0080	Torque command value	-2^{15} to $2^{15}-1$	CW, CR	x	2 bytes	D	P-0-0068	0	81
S-0-0081	Additive torque command value	-2^{15} to $2^{15}-1$	CW, CR	x	2 bytes	D	P-0-0109	0	81
S-0-0082	Positive torque limit value	0 to $2^{15}-1$	CW	x	2 bytes	D	P-0-1101	4096	82
S-0-0083	Negative torque limit value	0 to $2^{15}-1$	CW	x	2 bytes	D	P-0-1102	4096	82
S-0-0084	Torque feedback value	- to -	CR	-	2 bytes	D	P-0-1119	0	82
S-0-0085	Torque polarity parameter	- to -	-	-(CP4)	2 bytes	-	-	0	83
S-0-0086	Torque/force data scaling factor	- to -	-	-(CP4)	2 bytes	-	-	0xA	84
S-0-0087	Transmit to transmit recovery time (TATAT)	- to -	-	-	2 bytes	-	-	0	84
S-0-0089	MDT transmission starting time (T2)	0 to T_{scyc}	-	-(CP3, CP4)	2 bytes	1:1	-	0	84
S-0-0091	Bipolar velocity limit value	0 to $2^{31}-1$	CW	x	4 bytes	G	P-0-0081, P-0-0082	0	85
S-0-0092	Bipolar torque limit value	0 to $2^{15}-1$	CW	x	2 bytes	D	P-0-1113	0	85
S-0-0093	Torque/force data scaling factor	1 to $2^{16}-1$	-	-(CP4)	2 bytes	-	-	1	85
S-0-0094	Torque/force data scaling exponent	-9 to +3	-	-(CP4)	2 bytes	-	-	-2	85
S-0-0095	Diagnostic message	- to -	-	-	1 Byte, variable	-	-	0	86
S-0-0096	Slave arrangement (SLKN)	- to -	-	-	2 bytes	-	-	0	86
S-0-0097	Mask class 2 diagnostic	- to -	-	x	2 bytes	-	-	0xFFFF	86
S-0-0098	Mask class 3 diagnostic	- to -	-	x	2 bytes	-	-	0xFFFF	87
S-0-0099	Reset class 1 diagnostic	- to -	-	x	2 bytes	-	-	0	87
S-0-0100	Velocity loop proportional gain	0 to 1 000 000.00	-	x	4 bytes	100:1	P-0-0054	10.00	87
S-0-0101	Velocity loop integral action time	0 to 6553.5	-	x	2 bytes	10:1	P-0-0055	10.00	87
S-0-0102	Velocity loop differential time	0.0 to 100.0	-	x	2 bytes	10:1	P-0-0056	0	88
S-0-0103	Modulo value	1 to $2^{31}-1$	-	-(CP4)	4 bytes	L	P-0-0683	$36 \cdot 10^5$	88
S-0-0104	Position loop Kv-factor	0 to 655.35	-	x	2 bytes	100:1	P-0-0046	1.20	88
S-0-0106	Current loop proportional gain 1	1 to 10000.00	-	x	4 bytes	100:1	P-0-0136	10.00	88
S-0-0107	Current loop integral action time 1	0 to 65535	-	x	2 bytes	1:1	P-0-0137	5000	88
S-0-0108	Feedrate override	0 to 655.35	CW, CR	-	2 bytes	100:1	P-0-0676	100.00	89
S-0-0109	Motor peak current	0 to 6553.500	-	-(CP4)	4 bytes	1000:1	P-0-0851	0	89
S-0-0110	Amplifier peak current	0 to 1000.000	-	-	4 bytes	1000:1	P-0-0025	9.000	89
S-0-0112	Amplifier rated current	0 to 1000.00	-	-	4 bytes	1000:1	P-0-0026	4.500	89
S-0-0113	Maximum motor speed	1 to 24000.000	-	-(CP4)	4 bytes	$1 \cdot 10^4:1$	P-0-0342	3000.000	90
S-0-0114	Load limit of motor	0 to 1000	-	-	2 bytes	1:1	P-0-0029	100	90

B.2 List of S parameters

Parameter	Range		Writable	Length	Scaling	b maXX	Standard	Page	
S-0-0116	Resolution feedback 1 (motor feedback)	1 to 524288	-	-(CP3, CP4)	2 bytes	-	P-0-0950	1024	91
S-0-0118	Resolution feedback 2 (external feedback)	1 to 524288	-	-(CP3, CP4)	2 bytes	-	-	1024	91
S-0-0119	Current loop proportional gain 2	0 to 10000.00	-	x	4 bytes	100:1	P-0-0138	10.00	91
S-0-0120	Current loop integral action time 2	0 to 65535	-	x	2 bytes	1:1	P-0-0139	5000	91
S-0-0121	Load gear input revolutions	1 to $2^{32}-1$	-	-(CP4)	4 bytes	-	P-0-0681	1	92
S-0-0122	Load gear output revolutions	1 to $2^{32}-1$	-	-(CP4)	4 bytes	-	P-0-0682	1	92
S-0-0123	Feed constant	1 to $2^{32}-1$	-	-(CP4)	4 bytes	-	-	10000	92
S-0-0124	Standstill window	0 to $2^{31}-1$	-	x	4 bytes	G	P-0-0010	0	92
S-0-0125	Velocity threshold nx	0 to $2^{31}-1$	-	x	4 bytes	G	P-0-0018, P-0-0019	0	92
S-0-0126	Torque threshold Mx	0 to 65535	-	x	2 bytes	D	P-0-1122	0	93
S-0-0127	CP3 transition check	- to -	-	-(CP3, CP4)	2 bytes	-	-	0	93
S-0-0128	CP4 transition check	- to -	-	-(CP2, CP3, CP4)	2 bytes	-	-	0	93
S-0-0129	Manufacturer class 1 diagnostic	- to -	-	-	2 bytes	-	-	0	93
S-0-0130	Probe value 1 positive edge	-2^{31} to $+2^{31}-1$	CR	-	4 bytes	L	P-0-0704, P-0-0705	0	94
S-0-0131	Probe value 1 negative edge	-2^{31} to $+2^{31}-1$	CR	-	4 bytes	L	P-0-0706, P-0-0707	0	94
S-0-0132	Probe value 2 positive edge	-2^{31} to $+2^{31}-1$	CR	-	4 bytes	L	P-0-0720, P-0-0721	0	94
S-0-0133	Probe value 2 negative edge	-2^{31} to $+2^{31}-1$	CR	-	4 bytes	L	P-0-0723, P-0-0724	0	94
S-0-0134	Master control word	- to -	-	-	2 bytes	-	-	0	95
S-0-0135	Drive status word	- to -	-	-	2 bytes	-	-	0	97
S-0-0139	Park axis procedure command	- to -	-	-(CP2, CP3)	2 bytes	-	-	0	98
S-0-0140	Controller type	- to -	-	-	1 Byte, variable	-	-	-	98
S-0-0141	Motor type	- to -	-	- x	1 Byte, variable	-	P-0-0832	-	98
S-0-0142	Application type	- to -	-	-	1 Byte, variable	-	P-0-0262	-	98
S-0-0143	Sercos Interface Version	- to -	-	-	1 Byte, variable	-	-	-	98
S-0-0144	Signal statusword	- to -	CR	-	2 bytes, variable	-	-	0	99
S-0-0145	Signal controlword	- to -	CW	x	2 bytes, variable	-	-	0	99
S-0-0146	Control unit controlled homing procedure comm.	- to -	-	-(CP2, CP3)	2 bytes	-	-	0	99
S-0-0147	Homing parameter	- to -	-	x	2 bytes	-	-	0	100
S-0-0148	Drive-controlled homing procedure command	- to -	-	-(CP2, CP3)	2 bytes	-	-	0	101
S-0-0152	Position spindle procedure command	- to -	-	-(CP2, CP3)	2 bytes	-	-	0	102
S-0-0153	Spindle angle position	-2^{31} to $2^{31}-1$	-	x	4 bytes	L	P-0-0562	0	102
S-0-0154	Spindle positioning parameter	- to -	-	x	2 bytes	-	-	0	102
S-0-0155	Friction compensation	0 to $2^{15}-1$	-	x	2 bytes	D	P-0-1514, P-0-1516	0	103
S-0-0157	Velocity window	0 to $+2^{31}-1$	-	x	4 bytes	G	P-0-0015, P-0-0016	0	103
S-0-0159	Monitoring window	0 to $+2^{31}-1$	-	x	4 bytes	L	P-0-1142, P-0-1145	0	103
S-0-0160	Acceleration data scaling type	- to -	-	-(CP4)	2 bytes	-	-	0xA	104
S-0-0161	Acceleration data scaling factor	1 to $2^{16}-1$	-	-(CP4)	2 bytes	-	-	1	104
S-0-0162	Acceleration data scaling exponent	-9 to 3	-	-(CP4)	2 bytes	-	-	-3	105
S-0-0163	Weight counterbalance	-2^{15} to $2^{15}-1$	-	X	2 Bytes	-	P-0-1234	0	105
S-0-0169	Probe control parameter	- to -	-	x	2 bytes	-	-	0	106
S-0-0170	Probe cycle procedure command	- to -	-	-(CP2)	2 bytes	-	-	0	106
S-0-0171	Calculate displacement procedure command	- to -	-	-(CP2, CP3)	2 bytes	-	-	0	107
S-0-0172	Displacement to the referenced system command	- to -	-	-(CP2, CP3)	2 bytes	-	-	0	107

Parameter	Range		Writable	Length	Scaling	b maxX	Standard	Page
S-0-0173	Marker position A	$-2^{31}+1$ to $2^{31}-1$	-	4 bytes	L	-	0	108
S-0-0175	Displacement parameter 1	$-2^{31}+1$ to $2^{31}-1$	-	4 bytes	L	-	0	108
S-0-0176	Displacement parameter 2	$-2^{31}+1$ to $2^{31}-1$	-	4 bytes	L	-	0	108
S-0-0177	Absolute distance 1	$-2^{31}+1$ to $2^{31}-1$	-	4 bytes	L	-	0	109
S-0-0178	Absolute distance 2	$-2^{31}+1$ to $2^{31}-1$	-	4 bytes	L	-	0	109
S-0-0179	Probe status	- to -	CR	2 bytes	-	-	0	109
S-0-0180	Spindle relative offset	-2^{31} to $2^{31}-1$	-	4 bytes	L	P-0-0567	0	110
S-0-0181	Manufacturer class 2 diagnostic	- to -	-	2 bytes	-	-	0	110
S-0-0182	Manufacturer class 3 diagnostic	- to -	-	2 bytes	-	-	0	110
S-0-0183	Synchronization velocity window	0 to $2^{31}-1$	-	4 bytes	G	P-0-0545	10000	111
S-0-0185	Length of the configurable data record in the AT	- to -	-	2 bytes	-	-	64	111
S-0-0186	Length of the configurable data in the MDT	- to -	-	2 bytes	-	-	64	111
S-0-0187	IDN list of the configurable data in the AT	- to -	-	2 bytes, variable	-	-	*	111
S-0-0188	IDN list of the configurable data in the MDT	- to -	-	2 bytes, variable	-	-	*	112
S-0-0189	Position error	-2^{31} to $2^{31}-1$	CR	4 bytes	L	P-0-0075	0	112
S-0-0192	IDN list of all backup operation data	- to -	-	2 bytes, variable	-	-	*	112
S-0-0193	Positioning jerk	1 to $2^{32}-1$	-	4 bytes	-	P-0-0605, P-0-0505	1	113
S-0-0196	Motor rated current	0 to 6553.500	-	4 bytes	1000:1	P-0-0839	3.500	113
S-0-0197	Coordinate setting procedure command	- to -	-	2 bytes	-	-	0	113
S-0-0198	Start value of coordinate system	$-2^{31}-1$ to $+2^{31}-1$	-	4 bytes	L	-	0	114
S-0-0200	Amplifier warning temperature	0 to 150.0	-	2 bytes	10:1	-	0	114
S-0-0201	Motor warning temperature	0 to 185.0	-	2 bytes	10:1	P-0-0823, P-0-0824	130.0	114
S-0-0202	Cooling error warning temperature	0 to 255.0	-	2 bytes	10:1	P-0-0936	55.0	114
S-0-0203	Amplifier shut-down temperature	0 to 150.0	-	2 bytes	10:1	-	0	114
S-0-0204	Motor shut-down temperature	0 to 250.0	-	2 bytes	10:1	P-0-0857	150.0	114
S-0-0205	Cooling error shut-down temperature	0 to 255.0	-	2 bytes	10:1	P-0-0915	(dependent on power unit)	115
S-0-0206	Drive on delay time	0 to 1000.0	-	2 bytes	0.1 ms	P-0-1238	500.0	115
S-0-0207	Drive off delay time	0 to 1000.0	-	2 bytes	0.1 ms	P-0-1237	500.0	115
S-0-0208	Temperature data scaling type	- to -	-	2 bytes	1:1	-	0	115
S-0-0209	Lower adaption limit	0 to $+2^{31}-1$	-	4 bytes	G	P-0-1522	10	115
S-0-0210	Upper adaption limit	0 to $+2^{31}-1$	-	4 bytes	G	P-0-1523	10	116
S-0-0211	Adaption proportional gain	1.0 to 6553.5	-	2 bytes	10:1	P-0-1524	100.0	116
S-0-0212	Adaption integral action time	1.0 to 6553.5	-	2 bytes	10:1	P-0-1525	100.0	116
S-0-0222	Spindle positioning speed	0.0572 to 29999.0848	-	4 bytes	10000:1	P-0-0563	91.5527	117
S-0-0226	Lead spindle revolutions	1 to $2^{31}-1$	-	4 bytes	-	P-0-0543	1	117
S-0-0227	Synchronous spindle revolutions	-2^{31} to $2^{31}-1$	-	4 bytes	-	P-0-0542	1	117
S-0-0254	Actual parameter set	- to -	-	2 bytes	-	-	0	117
S-0-0258	Target position	-2^{31} to $2^{31}-1$	CW, CR	4 bytes	L	P-0-0600	0	118
S-0-0259	Positioning velocity	1 to $2^{31}-1$	CW, CR	4 bytes	G	P-0-0602, P-0-0502	0	118
S-0-0260	Positioning acceleration	0 to $2^{32}-1$	CW, CR	4 bytes	B	P-0-0603, P-0-0503	0	118
S-0-0261	Coarse positioning window	0 to $2^{32}-1$	-	4 bytes	L	P-0-0688	0	119
S-0-0262	Load defaults procedure command	- to -	-	2 bytes	-	-	0	119
S-0-0263	Load working memory procedure command	- to -	-	2 bytes	-	-	0	120
S-0-0264	Backup working memory procedure command	- to -	-	2 bytes	-	-	0	120
S-0-0265	Language selection	- to -	-	2 bytes	-	-	0	121

B.2 List of S parameters

Parameter	Range		Writable	Length	Scaling	b maXX	Standard	Page	
S-0-0266	List of available languages	- to -	-	-	2 bytes, variable	-	-	0	121
S-0-0271	Drive ID	0 to $2^{32}-1$	-	x	4 bytes	1:1	-	0	121
S-0-0272	Velocity window percentage	0.00 to 655.35	-	x	2 bytes	100:1	P-0-0954, P-0-0955	0	121
S-0-0283	Current coordinate offset	$-2^{31}+1$ to $2^{31}-1$	-	-	4 bytes	L	P-0-0020	0	122
S-0-0292	List of supported operation modes	- to -	-	-	2 bytes	1:1	-	*	122
S-0-0296	Velocity feed forward gain	0.00 to 200.00	-	x	4 bytes	100:1	P-0-0047	100.00	122
S-0-0300	Realtime control bit 1	- to -	-	x	2 bytes	-	-	-	123
S-0-0301	Allocation of realtime control bit 1	0 to 65535	-	x	2 bytes	-	-	-	123
S-0-0302	Realtime control bit 2	- to -	-	x	2 bytes	-	-	-	123
S-0-0303	Allocation of realtime control bit 2	0 to 65535	-	x	2 bytes	-	-	-	124
S-0-0304	Realtime status bit 1	- to -	-	-	2 bytes	-	-	-	124
S-0-0305	Allocation of realtime status bit 1	0 to 65535	-	x	2 bytes	-	-	-	124
S-0-0306	Realtime status bit 2	- to -	-	-	2 bytes	-	-	-	125
S-0-0307	Allocation of realtime status bit 2	0 to 65535	-	x	2 bytes	-	-	-	125
S-0-0310	Overload warning	- to -	-	-	2 bytes	-	-	-	125
S-0-0311	Amplifier overtemperature warning	- to -	-	-	2 bytes	-	-	-	126
S-0-0312	Motor overtemperature warning	- to -	-	-	2 bytes	-	-	-	126
S-0-0313	Cooling error warning	- to -	-	-	2 bytes	-	-	-	126
S-0-0315	Positioning velocity > nlimit	- to -	-	-	2 bytes	-	-	-	127
S-0-0323	Target position outside of travel range	- to -	-	-	2 bytes	-	-	-	127
S-0-0328	Bit No. allocation list signal statusword	- to -	-	- (CP3, CP4)	2 bytes	-	-	*	127
S-0-0330	Status nfeedback = ncommand	- to -	-	-	2 bytes	-	-	-	128
S-0-0331	Status nfeedback = 0	- to -	-	-	2 bytes	-	-	-	128
S-0-0332	Status nfeedback < nx	- to -	-	-	2 bytes	-	-	-	128
S-0-0333	Status T v Tx	- to -	-	-	2 bytes	-	-	-	129
S-0-0334	Status Td v Tdlimit	- to -	-	-	2 bytes	-	-	-	129
S-0-0335	Status ncommand > nlimit	- to -	-	-	2 bytes	-	-	--	129
S-0-0336	Status in-position	- to -	-	-	2 bytes	-	-	-	130
S-0-0338	Position feedback = active target position	- to -	-	-	2 bytes	-	-	0	130
S-0-0341	Status in coarse position	- to -	-	-	2 bytes	-	-	-	131
S-0-0342	Status target position attained	- to -	-	-	2 bytes	-	-	-	131
S-0-0346	Positioning control word	- to -	-	x	2 bytes	-	-	-	132
S-0-0347	Velocity error	-2^{32} to $+2^{31}-1$	CR	x	4 bytes	G	P-0-0053	0	134
S-0-0348	Acceleration feed forward gain	0.00 to 200.00	-	x	4 bytes	100:1	P-0-0062, P-0-0063	100.00	134
S-0-0359	Positioning deceleration	0 to $+2^{31}-1$	CW, CR	x	4 bytes	B	P-0-0604, P-0-0504	0	134
S-0-0372	Drive halt acceleration bipolar	1 to $+2^{31}-1$	CR	x	4 bytes	B	P-0-0677	200	135
S-0-0373	Service channel error list	- to -	-	-	4 bytes, variable	-	-	0.80	135
S-0-0374	Procedure command error list	- to -	-	-	4 bytes, variable	-	-	0.80	136
S-0-0375	Diagnostic numbers list	- to -	-	-	4 bytes, variable	-	-	0.8	137
S-0-0376	Baud rate	- to -	-	-	2 bytes	-	-	0x010F	138
S-0-0378	Absolute encoder range 1	0 to $2^{32}-1$	-	- (CP3, CP4)	4 Bytes	L	P-0-0951	0	139
S-0-0379	Absolute encoder range 2	0 to $2^{32}-1$	-	- (CP3, CP4)	4 Bytes	L	-	0	139
S-0-0380	DC bus voltage	10 to 1000	CR	-	2 bytes	1:1	P-0-0932	10	139
S-0-0383	Motor temperature	0.0 to 300.0	-	-	2 bytes	10:1	P-0-0822	0	139
S-0-0384	Amplifier temperature	0.0 to 1000.0	-	-	2 bytes	10:1	P-0-0930	0	139
S-0-0385	Active power	- 1000000 to 1000000	CR	-	4 Bytes	1:1	P-0-0031	0	140
S-0-0389	Effective current	0 to 10000.000	-	-	4 bytes	1000:1	P-0-0030	10	140
S-0-0390	Diagnostic numbers	0 to $2^{32}-1$	-	-	4 bytes	1:1	-	0	140

Parameter	Range		Writable	Length	Scaling	b maXX	Standard	Page	
S-0-0392	Velocity feedback filter	0 to 50000	-	x	2 bytes	1:1	P-0-0057	0	140
S-0-0393	Command value mode	- to -	-	x	2 bytes	-	-	0	140
S-0-0400	Home switch	- to -	-	-	2 bytes	-	-	0	141
S-0-0401	Probe 1	- to -	-	-	2 bytes	-	-	0	141
S-0-0402	Probe 2	- to -	-	-	2 bytes	-	-	0	141
S-0-0403	Position feedback value status	- to -	-	-	2 bytes	-	-	0	142
S-0-0404	Position reference value status	- to -	-	-	2 bytes	-	-	0	142
S-0-0405	Probe 1 enable	- to -	CW	x	2 bytes	-	-	0	143
S-0-0406	Probe 2 enable	- to -	CW	x	2 bytes	-	-	0	143
S-0-0407	Homing enable	- to -	-	x	2 bytes	-	-	0	143
S-0-0408	Reference marker pulse registered	- to -	-	-	2 bytes	-	-	0	144
S-0-0409	Probe 1 positive latched	- to -	-	-	2 bytes	-	-	0	144
S-0-0410	Probe 1 negative latched	- to -	-	-	2 bytes	-	-	0	145
S-0-0411	Probe 2 positive latched	- to -	-	-	2 bytes	-	-	0	145
S-0-0412	Probe 2 negative latched	- to -	-	-	2 bytes	-	-	0	146
S-0-0419	Positioning acknowledge	- to -	-	-	2 bytes	-	-	0	146
S-0-0429	Emergency Stop deceleration	0 to $+2^{31} - 1$	-	x	4 Bytes	B	P-0-0337	0	146
S-0-0430	Active target position	-2^{31} to $+2^{31} - 1$	CR	-	4 bytes	L	P-0-0568	-	147
S-0-0431	Spindle positioning acceleration bipolar	1 to $+2^{31} - 1$	-	-	4 bytes	B	P-0-0564	200	147
S-0-0432	Serial number drive controller	- to -	-	-	2 bytes, variable	-	-	0	147
S-0-0433	Serial number power stage	- to -	-	-	2 bytes, variable	-	-	0	148
S-0-0434	Serial number motor	- to -	-	-	2 bytes, variable	-	-	0	148
S-0-0435	Operating time drive control	0 to 1193046 h	-	-	4 bytes	1:1	P-0-0001	0 h	148
S-0-0436	Operating time power stage	0 to 1193046 h	-	-	4 bytes	1:1	P-0-0948	0 h	148
S-0-0437	Positioning status	- to -	-	-	2 bytes	-	-	0	148
S-0-0438	Vendor name	- to -	-	-	2 bytes, variable	-	-	*	148
S-0-0439	Vendor ID	- to -	-	-	4 bytes	-	-	346	148



Table of Figures

Identification code	14
Status values at commands	17
State machine	21
Sercos status word	22
General form of a master data telegram (MDT)	35
General form of response telegram (AT)	35
Bit string	47
Drive controlled homing	48
Bit sequence at Control unit controlled homing (case 1).....	49
Bit sequence at Control unit controlled homing (case 2.1).....	50
Bit sequence at Control unit-controlled homing (case 2.2)	50
Incremental measuring system	51
Bit sequence during execution of displacement.....	52
Bit sequence for command probe	53
Speed diagram for spindle positioning (1).....	56
Speed diagram for spindle positioning (2).....	57
Speed diagram for spindle positioning (3).....	58
Parameter description scheme	60
Speed polarities	74
Position polarities	79
Torque polarities	83

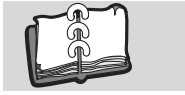

Table of Figures



Index

A		L	
Acceleration data	29	Limitation of liability	7
Allocation real-time bits	45	List of parameters	180
AT	35	Literature EtherCAT	8
C		M	
C1D	13	Message bit	154
C2D	13	N	
C3D	13	Network settings for EoE	37
Caution	6	Note	6
Communication parameters	34	Notice	6
Communication phase 2	12	P	
Communication phase 3	12	P parameters	19
Communication phase 4	12	Phase run-up	11
Communication phases	11	Preferred scaling	24
Configuration errors	149	Probe cycle	54
Copyright	7	R	
CP2	12	Real-time control bits	46
Customer service	8	Real-time status bits	46
Cyclic data	34	S	
D		S parameters	19
Danger	6	Scaling rotatory	25
Default values	59	Service data	33
E		State machine	20
Error parameters	150	T	
Error reset	154	Torque data	31
Errors of the drive controller	149	Touch probe	53
EtherCAT SoE	34	W	
Ethernet over EtherCAT	37	Warning	6
Explanation of symbols	6	Warning bit	154
F		Warnings	6
Fatal errors	149	I	
G		Identification code	14
Guarantee conditions	8	IDN	14
H		Init	12
Homing	49	Initialization data	34
I		Initialization phase	12



Index



Revision Survey

Version	Status	Changes
5.14006.01	27-Oct-2014	First edition
5.14006.02	16-Sep-2015	Changes because of firmware 1.09
5.14006.03	23-Jun-2016	Changes because of firmware 1.10
5.14006.04	16-May-2016	Changes because of firmware 1.11
5.14006.05	1-Mar-2018	Changes because of firmware 1.14



Notes

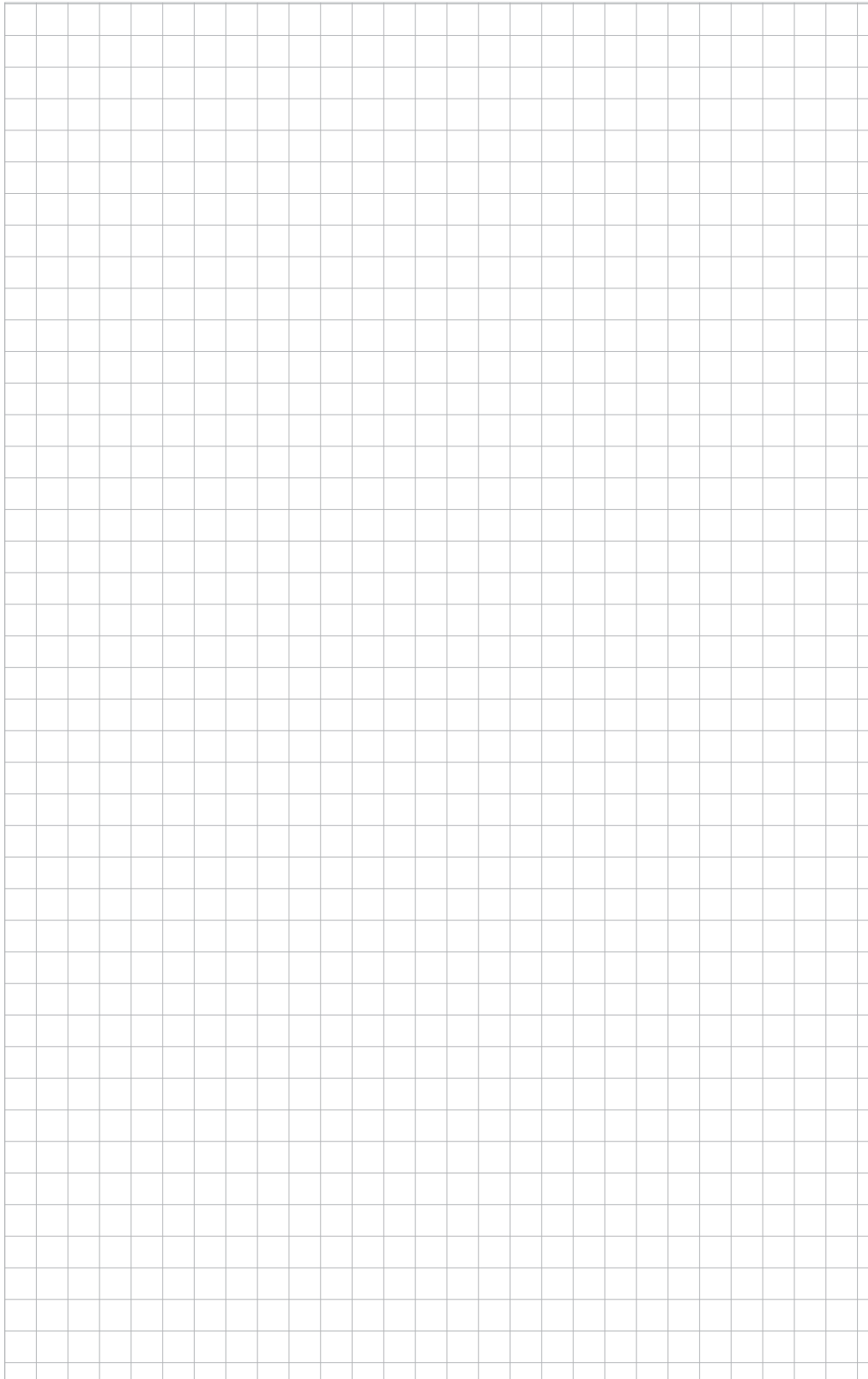

be in motion

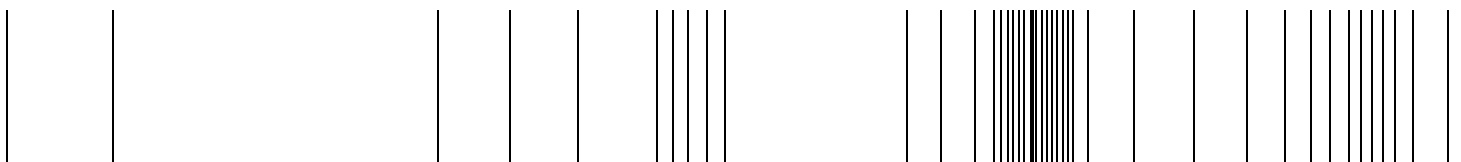

Baumüller Nürnberg GmbH Ostendstraße 80-90 90482 Nürnberg T: +49(0)911-5432-0 F: +49(0)911-5432-130 www.baumueller.de

All information given in this handbook is customer information, subject to change without notice. We reserve the right to further develop and actualize our products continuously using our permanent revision service. Please notice, that specifications/data/information are current values according to the printing date. These statements are not legally binding according to the measurement, computation and calculations. Before you make any information given in this manual to the basis of your own calculations and/or applications, please make sure that you have the latest edition of the information in hand. No liability can be accepted concerning the correctness of the information.