

be in motion be in motion

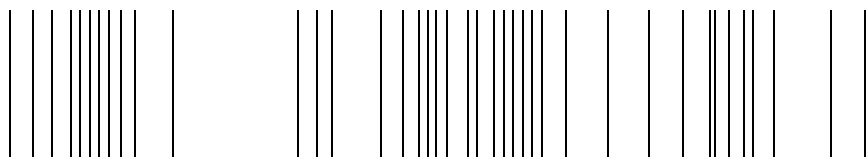

BMC-M-ECT-02

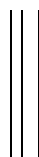

**Ethernet + EtherCAT-Master
for b maXX controller PLC**

Operating Instructions

E	5.06004.02
----------	------------



Title	Operating Instructions
Product	Ethernet + EtherCAT-Master for b maXX controller PLC BMC-M-ECT-02
Last Revision:	8 April 2009
Order no.	407993
Copyright	<p>Owners may make as many copies as they like of these Operating Instructions exclusively for their own internal use. You are not allowed to copy or duplicate even extracts from these Operating Instructions for any other purposes. You are not permitted to exploit or communicate the contents of these Operating Instructions.</p> <p>Any other designations or company logos used in these Operating Instructions may be trademarks whose use by third parties for their own purposes may affect the rights of the owner of the trademark.</p>
Binding nature	<p>These Operating Instructions are a part of the unit/machine. These Operating Instructions must always be available to operators and be legible. If the unit/machine is sold, the owner must pass on these Operating Instructions together with the unit/machine.</p> <p>After selling the unit/machine you must pass on this original and all the copies that you made to the purchaser. After disposing of the machine in any way, you must destroy this original and all the copies that you made.</p> <p>When you pass on these Operating Instructions, all earlier revisions of the corresponding Parameter Manual are invalidated.</p> <p>Note that all the data/numbers/information that are quoted are current values at the time of printing. This information is not legally binding for dimensioning, calculation and costing.</p> <p>Within the scope of further-development of our products, Baumüller Nürnberg GmbH reserve the right to change the technical data and handling.</p> <p>We cannot guarantee this Operating Instructions is completely error-free unless this is expressly indicated in our General Conditions of Business and Delivery.</p>
Manufacturer	Baumüller Nürnberg GmbH Ostendstr. 80 - 90 90482 Nuremberg Germany Tel. +49 9 11 54 32 - 0 Fax: +49 9 11 54 32 - 1 30 www.baumueller.de



1	Introduction	5
1.1	First Steps	5
1.2	Terms Used	5
2	Basic Safety Instructions	7
2.1	Hazard information and instructions	7
2.1.1	Structure of hazard information	8
2.1.2	Hazard advisories that are used	9
2.2	Information signs	11
2.3	Legal information	11
2.4	Appropriate Use	11
2.5	Inappropriate Use	12
2.6	Protective equipment	12
2.7	Personnel training	13
2.8	Safety measures in normal operation	13
2.9	Responsibility and liability	13
2.9.1	Observing the hazard information and safety instructions	13
2.9.2	Danger arising from using this module	14
2.9.3	Warranty and Liability	14
3	Packaging and transportation	15
3.1	Transportation	15
3.2	Unpacking	15
3.3	Disposing of the packaging	16
3.4	Observe during transportation	16
4	Description of the Ethernet with EtherCAT-Master module	17
4.1	Structure	17
4.2	Danger zones	18
4.3	Labeling of the module - type code	19
5	Assembly and installation	21
5.1	General safety regulations	21
5.2	Requirements of the personnel carrying out work	22
5.3	Preparing assembly	22
5.4	Installation space	23
5.5	Assembly instructions	23
5.6	Installation	28
5.6.1	Connection diagram	28
5.6.2	Requirements of electrical connection	29
5.6.3	Requirements of the connection cable	29
5.6.4	Sequence of installation	29
6	Commissioning	31
6.1	General safety regulations	31
6.2	Requirements of the personnel carrying out work	31
6.3	Description/inspection of the safety and monitoring systems	32
6.4	Description and inspection of the controls and displays	32
6.4.1	Sample Configuration	32
6.4.2	LEDs for displaying operating status conditions	32
6.4.3	Set the module address with rotary switch S1	36
6.4.4	Rotary switches S2/S3	37
6.4.5	Set the IP-address for Ethernet with rotary switches S4/S5	37
6.5	Commissioning sequence	38
6.5.1	Activation	39



TABLE OF CONTENTS

6.5.2	Testing the function	39
7	Operation	41
8	Finding and eliminating disturbances	43
8.1	Safety regulations	43
8.2	Requirements of the personnel carrying out work	43
8.3	Error messages (error list) responses to errors	43
9	Maintenance	47
10	Overhaul	49
11	Dismantling, storage	51
11.1	Safety regulations	51
11.2	Requirements of the personnel carrying out work	52
11.3	Dismantling	52
11.4	Storage conditions	54
11.5	Recommissioning	54
12	Disposal	55
12.1	Safety regulations	55
12.2	Requirements of the personnel carrying out work	55
12.3	Disposal guide	55
12.4	Disposal locations/official bodies	56
Appendix A - Abbreviations		57
Appendix B - Accessories		59
B.1	List of all accessories	59
B.1.1	EtherCAT cables	59
B.1.2	Ethernet cable	59
B.1.3	Ferrite	60
Appendix C - Declaration of Conformity		61
C.1	What is an EC directive?	61
C.2	What the CE symbol indicates	61
C.3	Definition of the term Declaration of Conformity	62
C.4	Declaration of Conformity	63
Appendix D - Technical Data		65
D.1	Connection values	65
D.2	Pin assignment of RJ45 female connector for Ethernet	66
D.3	Pin assignment of RJ45 female connector for EtherCAT	66
Revision index		67
Index		69

1

INTRODUCTION

These operating instructions are an important component of your b maXX system; this means that you must thoroughly read this document, not least to ensure your own safety.

In this chapter, we will describe the first steps that you should carry out after getting this unit. We will define terms that are used in this documentation on a consistent basis and will inform you about the responsibilities you must consider when using this unit.

For more detailed information on operating and deploying the module, refer to the documentation entitled "b maXX controller PLC Application Manual".

1.1 First Steps

- ◆ Check the shipment see [►Packaging and transportation ◀](#) from page 15 onward.
- ◆ Pass on all the documentation that was supplied with the module to the appropriate departments in your company.
- ◆ Deploy suitable personnel for assembly and commissioning.
- ◆ Pass on these operating instructions to this personnel and ensure that they have read and understood the safety instructions and that they are following them.

1.2 Terms Used

We will use the terms „Ethernet module“, „EtherCAT-Master“ or „EtherCAT-Master module“ for the „Ethernet with EtherCAT-Master for b maXX controller PLC“ product (BMC-M-ECT-02).

We will use the term "module" on its own when the text refers to the BMC-ECT-02 product in general.

We will use the term „PLC“ for the „b maXX controller PLC“ product (BMC-PLC-01/-02).

We will use the term „Power supply unit“ for the „Power supply unit for b maXX controller PLC“ product (BMC-PSB-01).

We will also use the term "b maXX system" for a product consisting of „b maXX controller PLC“, „Power supply unit“, „Ethernet with EtherCAT-Master for b maXX controller PLC“ and more components.

1.2 Terms Used

For a list of the abbreviations that are used, refer to [▶Appendix A - Abbreviations◀](#) from page 57 onward.

BASIC SAFETY INSTRUCTIONS

We have designed and manufactured each Baumüller module in accordance with the strictest safety regulations. Despite this, working with the module can be dangerous for you.

In this chapter, we will describe the risks that can occur when working with a Baumüller module. Risks are illustrated by icons. All the symbols that are used in this documentation are listed and explained.

In this chapter, we cannot explain how you can protect yourself from specific risks in individual cases. This chapter contains only general protective measures. We will go into concrete protective measures in subsequent chapters directly after information about the individual risk.

2.1 Hazard information and instructions



Hazard information will show you the dangers, that can lead to injuries or even to death. Always follow the hazard information given in this document.

Hazards are always divided into three danger classifications. Each danger classification is identified by one of the following words:

DANGER

- Considerable damage to property
- Serious personal injury
- Death **will** occur

WARNING

- Considerable damage to property
- Serious personal injury
- Death **can** occur

CAUTION

- Damage to property
- Slight to medium personal injury **can** occur

2.1 Hazard information and instructions

2.1.1 Structure of hazard information

The following two examples show how hazard information is structured in principle. A triangle is used to warn you about danger to living things. If there is no triangle, the hazard information refers exclusively to damage to property.



A triangle indicates that there is danger to living things. The color of the border shows how severe the hazard is: the darker the color, the more severe the hazard is.



The icon in the rectangle represents the hazard. The color of the border shows how severe the hazard is: the darker the color, the more severe the hazard is.



The icon in the circle represents an instruction. Users must follow this instruction. (The circle is shown dashed, since an instruction is not available as an icon for each hazard advisory).



The circle shows that there is a risk of damage to property.



The icon in the rectangle represents the hazard. The color of the border shows how severe the hazard is: the darker the color, the more severe the hazard is. (The rectangle is shown dashed, since the danger is not represented as an icon with every hazard advisory)

The text next to the icons is structured as follows:

THE SIGNAL WORD IS HERE THAT SHOWS THE DEGREE OF RISK



Here we indicate whether one or more of the results below occurs if you do not observe this warning.

- Here, we describe the possible results. The worst result is always at the extreme right.

Here, we describe the hazard.

Here, we describe what you can do to avoid the hazard.

2.1.2 Hazard advisories that are used

If a signal word is preceded by one of the following danger signs:  or  or , the safety information refers to injury to people.

If a signal word is preceded by a round danger sign: , the safety information refers to damage to property.

2.1.2.1 Hazard advisories about injuries to people

To be able to differentiate visually, we use a separate border for each class of hazard information with the triangular and rectangular pictograms.

For danger classification **DANGER**, we use the  danger sign. The following hazard information of this danger classification is used in this documentation.

DANGER



The following **will occur**, if you do not observe this danger information:

- serious personal injury
- death

*Danger from: **electricity**. The hazard may be described in more detail here.*

Here, we describe what you can do to avoid the hazard.



DANGER



The following **will occur**, if you do not observe this danger information:

- serious personal injury
- death

*Danger from: **mechanical effects**. The hazard may be described in more detail here.*

Here, we describe what you can do to avoid the hazard.



For danger classification **WARNING**, we use the  danger sign. The following hazard information of this danger classification is used in this documentation.

WARNING



The following **may occur**, if you do not observe this warning information:

- serious personal injury
- death

*Danger from: **electricity**. The hazard may be described in more detail here.*

Here, we describe what you can do to avoid the hazard.



For danger classification **CAUTION**, we use the  danger sign. The following hazard information of this danger classification is used in this documentation.

2.1 Hazard information and instructions



CAUTION

The following **may occur**, if you do not observe this caution information:

- minor to medium personal injury.

*Danger from: **sharp edges**. The hazard may be described in more detail here.*

Here, we describe what you can do to avoid the hazard.



CAUTION

The following **may occur**, if you do not observe this danger information:

- environmental pollution.

*Danger from: **incorrect disposal**. The hazard may be described in more detail here.*

Here, we describe what you can do to avoid the hazard.



2.1.2.2 Hazard advisories about damage to property

If a signal word is preceded by a round danger sign: ⓘ, the safety information refers to damage to property.



CAUTION

The following **may occur**, if you do not observe this caution information:

- property damage.

*Danger from: **electrostatic discharge**. The hazard may be described in more detail here.*

Here, we describe what you can do to avoid the hazard.



2.1.2.3 Instruction signs that are used



wear safety gloves



wear safety shoes

2.2 Information signs



NOTE

This indicates particularly important information.

2.3 Legal information

This documentation is intended for technically qualified personnel that has been specially trained and is completely familiar with all warnings and maintenance measures.

The equipment is manufactured to the state of the art and is safe in operation. It can be put into operation and function without problems if you ensure that the information in the documentation is complied with.

Operators are responsible for carrying out servicing and commissioning in accordance with the safety regulations, applicable standards and any and all other relevant national or local regulations with regard to cable rating and protection, grounding, isolators, over-current protection, etc.

Operators are legally responsible for any damage that occurs during assembly or connection.

2.4 Appropriate Use

You must always use the module appropriately. Some important information is listed below. The information below should give you an idea of what is meant by appropriate use of the module. The information below has no claim to being complete; always observe all the information that is given in these operating instructions.

- You must only add on the module to a b maXX controller PLC (or another system component plugged left hand of the b maXX controller PLC).
- Configure the application such that the module is always operating within its specifications.
- Ensure that only qualified personnel works with this module.
- Mount the module only on a b maXX controller PLC (or another system component plugged left hand of the b maXX controller PLC).
- Install the module as specified in this documentation.
- Ensure that connections always comply with the stipulated specifications.
- Operate the module only when it is in technically perfect condition.
- Always operate the module in an environment that is specified in the technical data.
- Always operate the module in a standard condition.
For safety reasons, you must not make any changes to the module.
- Observe all the information on this topic if you intend to store the module.

You will be using the module in an appropriate way if you observe all the comments and information in these operating instructions.

2.5 Inappropriate Use

Below, we will list some examples of inappropriate use. The information below should give you an idea of what is meant by inappropriate use of the module. We cannot, however, list all possible cases of inappropriate use here. Any and all applications in which you ignore the information in this documentation are inappropriate; particularly, in the following cases:

- You added the module on another unit/module as the b maXX controller PLC (or another system component plugged left hand of the b maXX controller PLC).
- You ignored information in these operating instructions.
- You did not use the module as intended.
- You handled the module as follows
 - you mounted it incorrectly,
 - you connected it incorrectly,
 - you commissioned it incorrectly,
 - you operated it incorrectly,
 - you allowed non-qualified or insufficiently qualified personnel to mount the module, commission it and operate it,
 - you overloaded it,
- You operated the module
 - with defective safety devices,
 - with incorrectly mounted guards or without guards at all,
 - with non-functional safety devices and guards
 - outside the specified environmental operating conditions
- You modified the module without written permission from Baumüller Nürnberg GmbH.
- You ignored the maintenance instructions in the component descriptions.
- You incorrectly combined the module with third-party products.
- You combined the b maXX system with faulty and/or incorrectly documented third-party products.
- Your self-written PLC software contains programming errors that lead to a malfunction.

Version 1.1 of Baumüller Nürnberg GmbH's General Conditions of Sale and Conditions of Delivery dated 2/15/02 or the respective latest version applies in all cases. These will have been available to you since the conclusion of the contract at the latest.

2.6 Protective equipment

In transit, the modules are protected by their packaging. Do not remove the module from its packaging until just before you intend to mount it.

The housing of the module provides IP20 protection to the modules from dirt and damage due to static discharges from contact. This means that you never use a module with damaged housing.

2.7 Personnel training



WARNING

The following **may occur**, if you do not observe this warning information:

- serious personal injury
- death

Only qualified personnel are allowed to mount, install, operate and maintain equipment made by Baumüller Nürnberg GmbH.

Qualified personnel (specialists) are defined as follows:

Qualified Personnel

Electrical engineers and electricians of the customer or of third parties who are authorized by Baumüller Nürnberg GmbH and who have been trained in installing and commissioning Baumüller b maXX systems and who are authorized to commission, ground and mark circuits and equipment in accordance with recognized safety standards.

Qualified personnel has been trained or instructed in accordance with recognized safety standards in the care and use of appropriate safety equipment.

Requirements of the operating staff

The b maXX system may only be operated by persons who have been trained and are authorized.

Only trained personnel are allowed to eliminate disturbances, carry out preventive maintenance, cleaning, maintenance and to replace parts. These persons must be familiar with the Operating Instructions and act in accordance with them.

Commissioning and instruction must only be carried out by qualified personnel.

2.8 Safety measures in normal operation

- ▶ At the b maXX systems' place of installation, observe the applicable safety regulations for the plant in which this unit is installed.
- ▶ Provide the b maXX system with additional monitoring and protective equipment if the safety regulations demand this.
- ▶ Observe the safety measures for the unit in which the module is installed.

2.9 Responsibility and liability

To be able to work with this module in accordance with the safety requirements, you must be familiar with and observe the hazard information and safety instructions in this documentation.

2.9.1 Observing the hazard information and safety instructions

In these operating instructions, we use visually consistent safety instructions that are intended to prevent injury to people or damage to property.



WARNING

The following **may occur**, if you do not observe this warning information:

- serious personal injury
- death

Any and all persons who work on and with Series b maXX units must always have available these Operating Instructions and must observe the instructions and information they contain – this applies in particular to the safety instructions.

Apart from this, any and all persons who work on this unit must be familiar with and observe all the rules and regulations that apply at the place of use.

2.9.2 Danger arising from using this module

The Ethernet with EtherCAT-Master module for b maXX controller PLC has been developed and manufactured to the state of the art and complies with applicable guidelines and standards. It is still possible that hazards can arise during use. For an overview of possible hazards, refer to the chapter entitled [▶Basic Safety Instructions ◀](#) from page 7 onward.

We will also warn you of acute hazards at the appropriate locations in this documentation.

2.9.3 Warranty and Liability

All the information in this documentation is non-binding customer information; it is subject to ongoing further development and is updated on a continuous basis by our permanent change management system.

Warranty and liability claims against Baumüller Nürnberg GmbH are excluded; this applies in particular if one or more of the causes listed in [▶Inappropriate Use ◀](#) from page 12 onward or below caused the fault:

- Disaster due to the influence of foreign bodies or force majeure.

PACKAGING AND TRANSPORTATION

We package every Baumüller module before shipping such that it is highly unlikely that it will be damaged in transit.

3.1 Transportation

The modules are packed at the factory in accordance with the order.

- ▶ Avoid severe vibrations and jolts (max. 1 g) in transit.
- ▶ Avoid static discharges to the modules' electronic components.
- ▶ Do not remove the module from its protective packaging until just before you intend to mount it.

3.2 Unpacking

After receiving the module while it is still packaged:

- ▶ Check whether there is any visible damage!

If there is:

- ▶ Complain to the delivery company. Have your complaint confirmed in writing and contact immediately your nearest Baumüller Nürnberg GmbH subsidiary.

CAUTION



The following **may occur**, if you do not observe this caution information:

- property damage.



*Danger from: **electrostatic discharge**. If you touch the plug-in module, and especially its electronic components, and subject them to electrostatic discharges, the module can be damaged or even totally destroyed.*

When handling the plug-in module, always observe the regulations and information on handling electrostatically sensitive components.

3.3 Disposing of the packaging

If no damage is visible:

- ▶ Open the module's packaging.
- ▶ Check the scope of supply against the delivery note.

The scope of supply is:

- BMC-M-ECT-02 Ethernet option module with EtherCAT-Master
- these Operating Instructions including the declaration of conformity/manufacturer declaration
- ▶ complain to your local Baumüller subsidiary if you find damage or if the delivery is not complete.

3.3 Disposing of the packaging

The packaging consists of cardboard and plastic.

- ▶ Observe local disposal regulations if you intend to dispose of the packaging.

3.4 Observe during transportation

The module was packaged at the manufacturer's plant for initial transportation. If you have to transport the module at a later date, please note the following points:

- ▶ Use the original packaging material
- or
- ▶ Use packaging that is suitable for electrostatic sensitive devices.

Ensure that the transport conditions (see [▶Appendix D - Technical Data](#) from page 65 onward) always apply during transportation.

DESCRIPTION OF THE ETHERNET WITH ETHERCAT-MASTER MODULE

In this chapter, we will describe the Ethernet with EtherCAT-Master module for b maXX controller PLC and will explain the type code on the plug-in module.

4.1 Structure

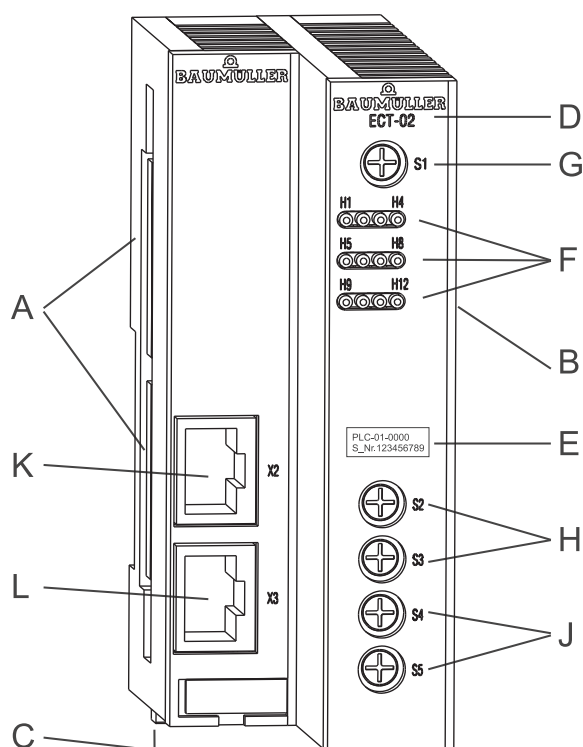

- A = Socket (to other system components)
- B = Plug (to power supply unit)
- C = Interlock deactivating grip (white, bottom)
- D = code designation
- E = Type label
- F = LEDs
- G = Rotary switch S1 (module address)
- H = Rotary switch S2, S3 (reserved)
- J = Rotary switch S4, S5 (Ethernet address)
- K = EtherCAT RJ45
- L = Ethernet RJ45

Figure 1: Ethernet with EtherCAT-Master module

4.2 Danger zones

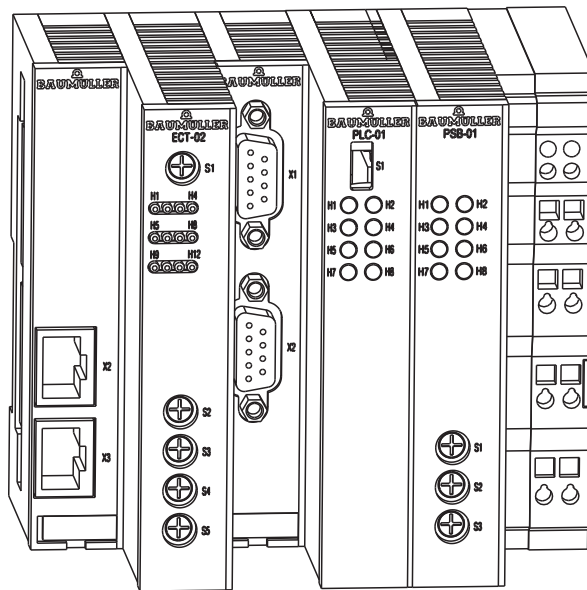

Figure 2: Ethernet with EtherCAT-Master + b maXX controller PLC and Power supply unit



NOTE

If you don't plug the module to the b maXX controller PLC (or another system component for b maXX controller PLC), the b maXX system does not function.

4.2 Danger zones

The illustration below gives you an overview of the danger zones in the module.

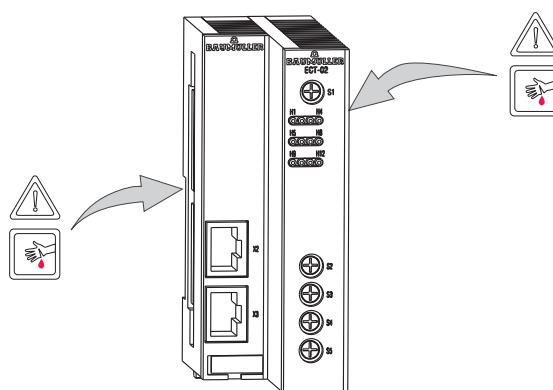

Figure 3: Danger zones

In so far there is a danger from the module only, when an application program on the b maXX controller PLC controls a machine or system and this machine or system enables unwanted or wrong actions and therewith is a danger.

4.3 Labeling of the module - type code

On the front panel, you will find the type code ("E" in [▶Figure 1◀](#) on page 17) of the plug-in module.

NOTE



This type code applies only to the module of series b maXX systems. Other modules have their own type codes.

<u>BMC</u> - M - ECT - XX - YY - ZZ	Device generation in which you can install the module
BMC - <u>M</u> - ECT - XX - YY - ZZ	Module
BMC - M - <u>ECT</u> - XX - YY - ZZ	Modultyp (für b maXX controller PLC)
BMC - M - ECT - <u>XX</u> - YY - ZZ	Version module: 01: Ethernet with EtherCAT-Slave 02: Ethernet with EtherCAT-Master 03: Ethernet with EtherCAT-Cluster
BMC - M - ECT - XX - <u>YY</u> - ZZ	Version hardware 10: Standard version
BMC - M - ECT - XX - YY - <u>ZZ</u>	Version software 00: Standard version see table versions

Table versions ECT-02-00-ZZ

- ZZ	Meaning
00	Ethernet for <ul style="list-style-type: none"> ○ ProMaster ○ ProProg wt III ○ OPC server

NOTE



All modules in hardware version „-1x-“ are **incompatible** to the modules in the hardware version „-0x-“, because wrap connections between power supply, PLC and possible field bus modules were changed. Only modules in hardware version „-1x-“ can be stuck together.

Example: Ethernet with EtherCAT master
for b maXX controller PLC
b maXX controller PLC

BMC-M-ECT-02-**10**-00 and
BMC-M-PLC-01-**11**-02

4.3 Labeling of the module - type code

This type code is located on the front of the module („E“ in [▶Figure 1◀](#) on page 17). The type code contains the module's basic data. For a list of all the technical data, refer to [▶Appendix D - Technical Data◀](#) from page 65 onward.

ASSEMBLY AND INSTALLATION

In this chapter, we will describe mechanical assembly and electrical installation of the module for b maXX controller PLC.

Assembly/installation consists of the following steps:

- 1 Mount the module.
- 2 Connect the module to the power supply.

5.1 General safety regulations

- ▶ Observe the information in chapters ▶[Basic Safety Instructions](#) ◀ from page 7 onward.
- ▶ Observe all areas on the b maXX system that could be dangerous when you are carrying out assembly.

The figure below gives you an overview of the danger zones on the module.

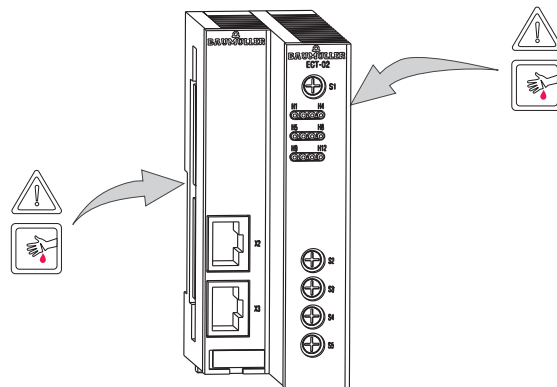

Figure 4: Danger zones

5.2 Requirements of the personnel carrying out work



DANGER

The following **will occur**, if you do not observe this danger information:

- serious personal injury
- death

*Danger from: **electricity**. The b maXX system and the vicinity of the control cabinet may carry dangerous voltages.*

Before starting any work, ensure that the b maXX system and its vicinity are free of voltage.

Observe the relevant safety regulations when handling current-carrying units.

Ensure that only qualified personnel assembles and installs this module.

Qualified personnel is considered to be people whose training, experience and knowledge of relevant standards and regulations, accident prevention regulations and conditions in the plant has led to their being authorized by the plant safety manager to carry out activities that are needed in each case while recognizing and avoiding any possible hazards that might arise. The qualifications that are necessary for working with the unit include, for example:

- Trained or instructed in accordance with recognized safety standards in the care and use of appropriate safety equipment

5.3 Preparing assembly

With the configuring documents of the system you can prepare the assembly. With the required installation space (see [►Installation space ◀](#) from page 23 onward) you determine the location of the 35 mm C profile (top-hat rail, see [►Appendix D - Technical Data◀](#) from page 65 onward) and determine the dimension for the fixing holes.



CAUTION

The following **may occur**, if you do not observe this caution information:

- minor to medium personal injury.

*The danger is: **Eye injury due to catapulting particles**. While executing the drillings and the cut-out metal particles are catapulted.*



wear eye protection

- Carry out the drillings and mount the 35 mm C profile

5.4 Installation space

The following drawings show you the height dimensions and the depth gauge of the modules of the b maXX system. Use these drawings in order to determine the required space in the control cabinet.

The module's width is variable. In order to determine the width of your b maXX system, you have got to add the width of the modules you want to use. If necessary, pay attention to the restrictions of the number of modules which can be used at one power supply unit.

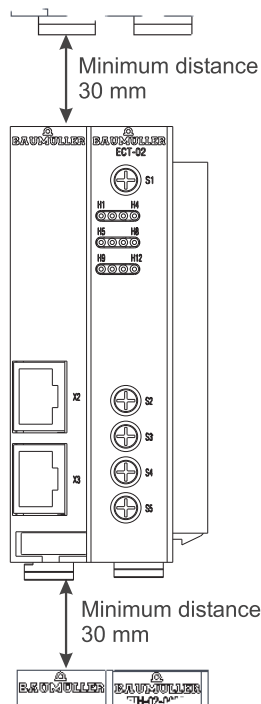

Figure 5: Installation space b maXX system

NOTE



The indicated distances are minimum clearances. Due to the cable routing this distances may be greater than the minimum (see [▶Sequence of installation ◀](#) from page 29 onward).

5.5 Assembly instructions

Please note that the module can be assembled with the b maXX controller PLC only (and if necessary with other system components at b maXX controller PLC).

Therefore, for assembling keep ready the Ethernet with CANopen-Master module, the b maXX controller PLC with power supply unit and if necessary other system components.



DANGER

The following **will occur**, if you do not observe this danger information:

- serious personal injury
- death

*Danger from: **electricity**. The unit and the vicinity of the control cabinet may carry dangerous voltages.*

Before starting any work, ensure that the unit and its vicinity are free of voltage. Observe the relevant safety regulations when handling current-carrying units.

The following materials are needed:

- Suitable tools for opening the spring energy clamp of the electrical terminal (2-mm wide screwdriver)
 - Suitable tools for pulling out the white grip at the bottom of the module (e.g. pointed electronic pliers)
- Consult the type code (see "E" in ►Figure 6 on page 24) to ensure that you have the correct module.

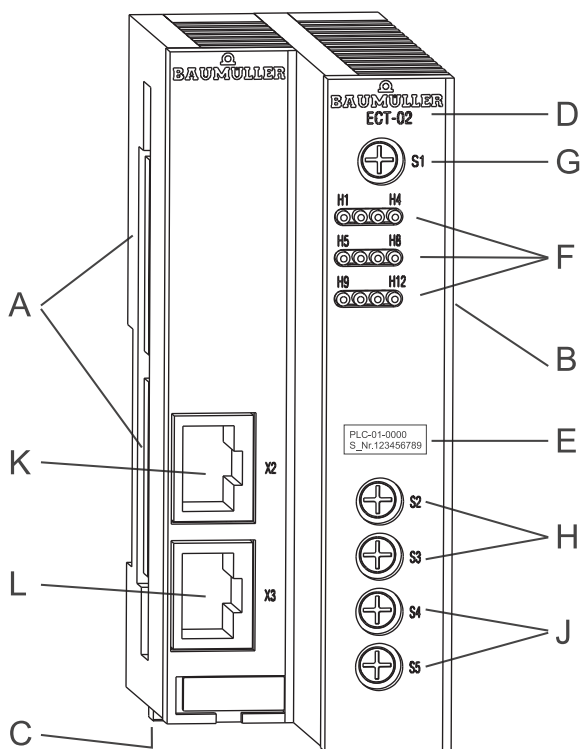

- A = Socket (to other system components)
- B = Plug (to power supply unit)
- C = Interlock deactivating grip (white, bottom)
- D = code designation
- E = Type label
- F = LEDs
- G = Rotary switch S1 (module address)
- H = Rotary switch S2, S3 (reserved)
- J = Rotary switch S4, S5 (Ethernet address)
- K = EtherCAT RJ45
- L = Ethernet RJ45

Figure 6: Ethernet with EtherCAT-Master module

- 1 Switch off the power supply of the power supply unit for b maXX controller PLC and secure it from being unintentionally restarted during assembly. If necessary dismantle already connected cables.
- 2 Open the control cabinet.
- 3 Stick the power supply unit together with the b maXX controller PLC.

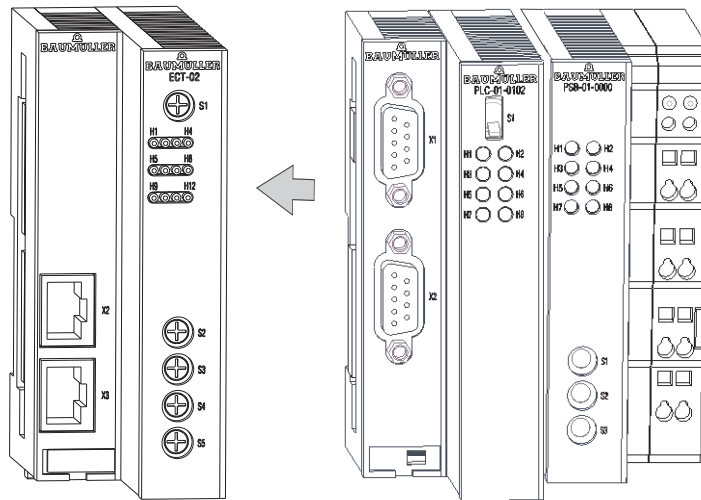

Figure 7: Ethernet with EtherCAT-Master + b maXX controller PLC with power supply unit

If necessary mount more system components for the b maXX controller PLC on the left hand of the b maXX controller PLC.

NOTE



If you doesn't plug the module to the b maXX controller PLC (or on other system components for b maXX controller PLC), the b maXX system does not function.

- 4 On the left hand of the bottom of the power supply unit a white grip is located. Pull this grip towards the bottom and then pull forward. The grip engages.
Repeat this step at the b maXX controller PLC (two grips).
Repeat this step at the Ethernet with CANopen-Master module (two grips).
If necessary repeat this step at other system components for the b maXX controller PLC (which have been put to the left hand of the b maXX controller PLC).

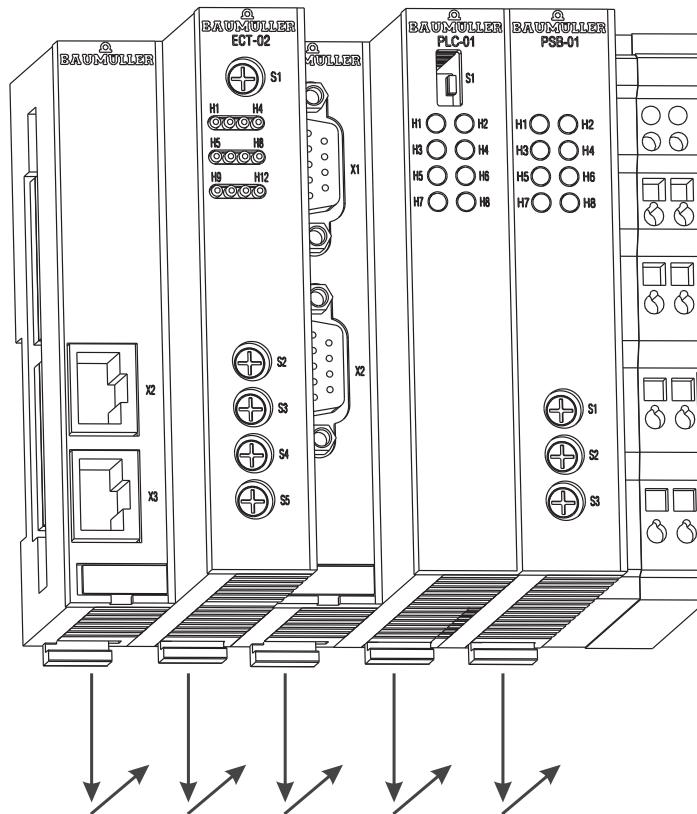

Figure 8: Ethernet with EtherCAT-Master, b maXX controller PLC and power supply unit

- 5 With a little screwdriver pull the orange grip on the right hand of the power supply unit forward so that the grip can be seized in a good manner.

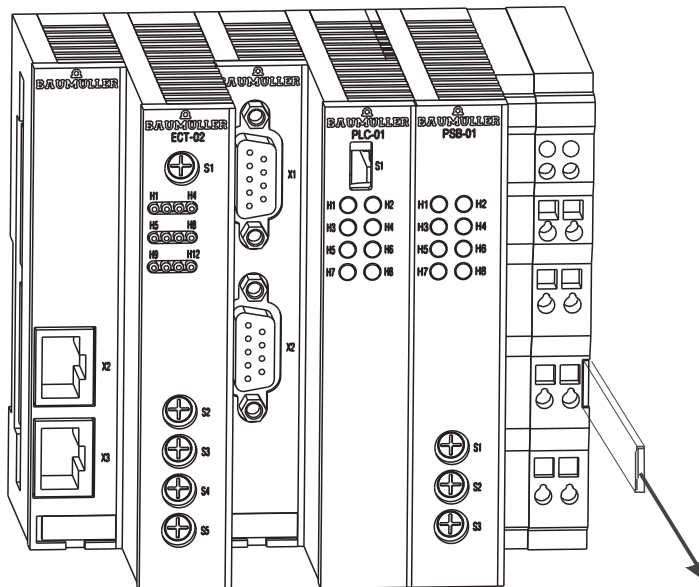

Figure 9: Ethernet with EtherCAT-Master, b maXX controller PLC and power supply unit

- 6 Now plug the module block in the 35 mm C profile and hold onto it.
- 7 Pull the orange grip on the right hand of power supply unit forward and press at the same time the module block backwards.
- 8 Unhand the orange grip. The right part of the power supply unit engages on the 35 mm C profile.
- 9 Shift the orange grip into the module. Thus an inadvertently breaking of the grip is prevented.
- 10 Press the white grip at the bottom of the left part of the power supply backwards. Thus the white grip jumps out and the left part of the power supply engages on the 35 mm C profile.
Repeat this step with the b maXX controller PLC (two grips). Thus the b maXX controller PLC engages on the 35 mm C profile.
Repeat this step with the Ethernet with CANopen-Master module (two grips). Thus the module engages on the 35 mm C profile.
If necessary repeat this step with other system components for b maXX controller PLC (placed on the left hand of the b maXX controller PLC). Thus the other system components engage on the 35 mm C profile.
- 11 Now you can mount other system components (e.g. I/O-modules) on the right hand of the power supply unit. Observe to the according operation instructions.
- 12 Set the module address at rotary switch S1. This module address is used to transfer data between b maXX controller PLC and the module.



Figure 10: Example: Set the module address 1 (rotary switch on 1)

Ethernet

Set the IP-address of the Ethernet module via the rotary switches 4 and 5 (see Ethernet with EtherCAT-Master Application Manual)



Figure 11: Example: Set the Ethernet address 192.168.1.10 (rotary switch S4 on 0 and rotary switch S5 on 9)

5.6 Installation

The IP address results from

192.168.1.“1+DIP switch“

This is the default address. You can change the address in software after commissioning (see the Application Manual for Ethernet with EtherCAT-Master). The default setting for the subnet mask is 255.255.255.0; for the gateway, it is 0.0.0.0, i.e. a gateway is not used. You can also change the subnet mask and the gateway in software after commissioning.



NOTE

The rotary switches S2 and S3 are reserved.

5.6 Installation

At installation, carry out cabling of the Ethernet with EtherCAT-Master module for b maXX controller PLC.

5.6.1 Connection diagram

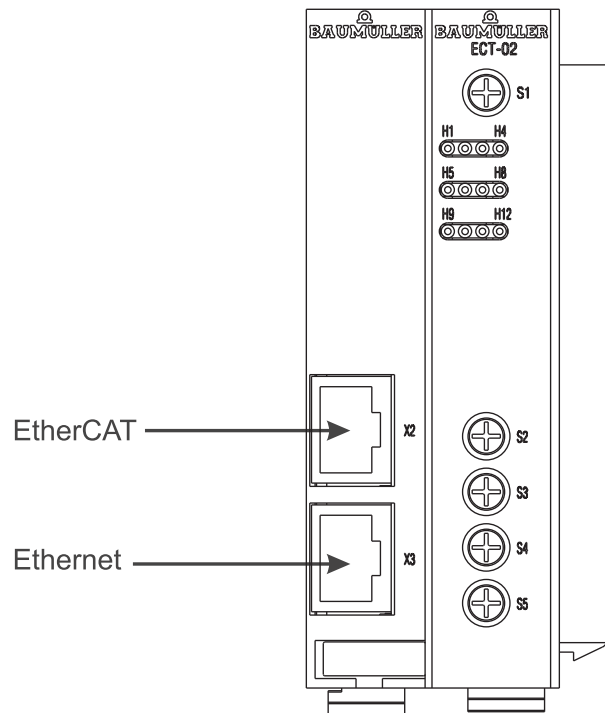

Figure 12: Connection diagram for Ethernet with EtherCAT-Master module for b maXX controller PLC

Pin assignment of X2 (EtherCAT) and X3 (Ethernet) see [►Appendix D - Technical Data◀](#) from page 65 onward.

5.6.2 Requirements of electrical connection



CAUTION

The following **may occur**, if you do not observe this caution information:

- property damage.

Danger from: **electrical voltage**. *If you are not able to ensure the module's requirements of the electrical connection, the plug-in module can be damaged or destroyed.*

Ensure that you comply with the connection values that are specified in the technical data and that the connections were made in accordance with the stipulations.

Prevent short-circuits between inputs/outputs. In the case of a short-circuit between inputs/outputs, the plug-in module can be destroyed.

To be able to comply with Standard EN 60 204-1 (Electrical Equipment of Machines), you must use the cables that are suggested in the standard. The connectors must not drop; otherwise, there is a risk of short-circuits or external voltages, etc.

- Ensure EMC-appropriate laying of the connection cables.

5.6.3 Requirements of the connection cable

Baumüller has released the following cables for use:

- EtherCAT communication cable K-ETH-33-0-xx (see Appendix [▶B.1 List of all accessories](#) on page 59)
- Ethernet cable K-ETH-33-0-xx and crossover adapter or coupling (see Appendix [▶B.1.2 Ethernet cable](#) from page 59 onward)

5.6.4 Sequence of installation

- Ensure that the b maXX system is deenergized.
- Ensure that the external power supply unit is switched off and protected against re-start.
- **EtherCAT:**
Connect 8-pin RJ45 female connector X2 on the left hand of the front panel to the EtherCAT communication cable; for the connection assignment, see [▶Appendix D - Technical Data](#) from page 65 onward.
- **Ethernet:**
Connect 8-pin RJ45 female connector X3 on the module's left hand to the Ethernet communication cable (CAT5 twisted pair); for the connection assignment, see [▶Appendix D - Technical Data](#) from page 65 onward.
The Ethernet module detects network types 10BaseT (10 Mbit) and 100BaseTX (100 Mbit) by the ongoing traffic and sets itself automatically. As an option to connecting with a star coupler (hub or switch), you can also connect the Ethernet module directly to a PC. In this case, you must use a cross-link cable.

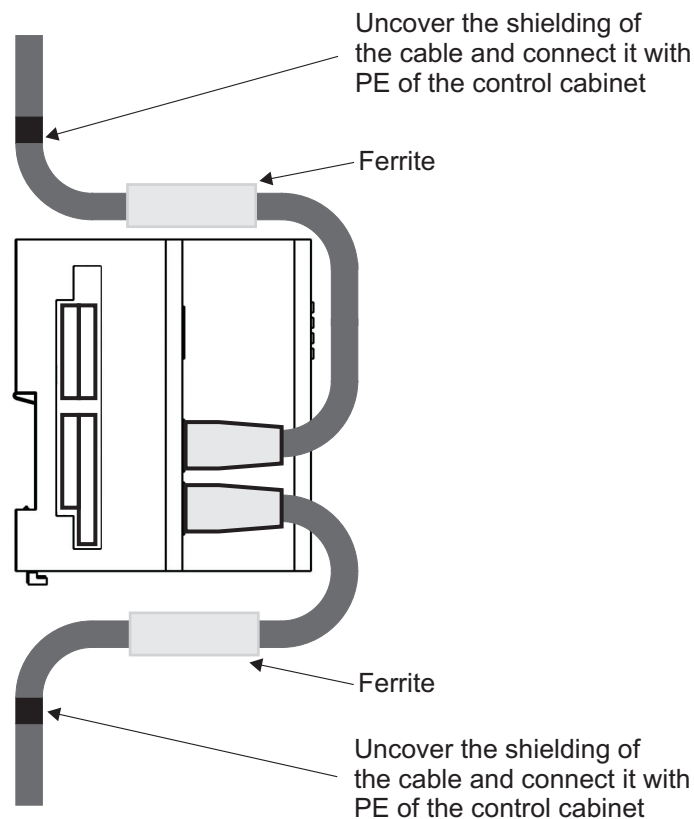

Figure 13: Cable routing

- ▶ Lay the connecting lines as stipulated in ▶[Figure13](#)◀. First the shielding of the cable must be uncovered. The length of the uncovered shielding should correspond to the width of the cable clamp. The cable is fastened with the clamp so that the shielding and the PE of the control cabinet are connected electrically.
- ▶ Mount a ferrite on every cable between the plug and the contact area on the mounting plate (see ▶[Figure13](#)◀) to reduce the electromagnetic perturbing radiation.

This completes installation.

COMMISSIONING

In this chapter, we will describe how you commission the module for b maXX controller PLC that you just assembled and installed (see [►Assembly and installation ◀](#) from page 21 onward). Commissioning ensures that the Ethernet with CANopen-Master module for b maXX controller PLC functions correctly.

Before starting commissioning, ensure that the following conditions have been met:

- 1 The module has been assembled correctly.
- 2 The module has been installed correctly.
- 3 All the safety equipment has been commissioned.
- 4 The b maXX system is ready for use.

6.1 General safety regulations

- Observe the [►Basic Safety Instructions ◀](#) from page 7 onward.



DANGER

The following **will occur**, if you do not observe this danger information:

- serious personal injury
- death



Danger from: **mechanical effects**. *At commissioning, parts of the machine/system or the complete machine/system can move.*

Keep far enough from the moving parts of the machine/system. Note that from the connected (to the b maXX controller PLC) other modules machine parts can be set in motion. In all cases, activate the machine's safety devices.

6.2 Requirements of the personnel carrying out work

Commissioning work must only be carried out by trained specialists who have understood the safety regulations and information and can implement them.

6.3 Description/inspection of the safety and monitoring systems

6.3 Description/inspection of the safety and monitoring systems

Before you commission the Ethernet with CANOpen-Master module for b maXX controller PLC, you must ensure that the 24 V power supply is connected correctly to the power supply unit for b maXX controller PLC and that the power supply is in accordance with the specifications in [►Appendix D - Technical Data◄](#) from page 65 onward. Not until you have checked and ensured this, you may continue commissioning.

Consider during commissioning that the module can be commissioned only together with the b maXX controller PLC, the power supply unit and if necessary other system components.

6.4 Description and inspection of the controls and displays

6.4.1 Sample Configuration

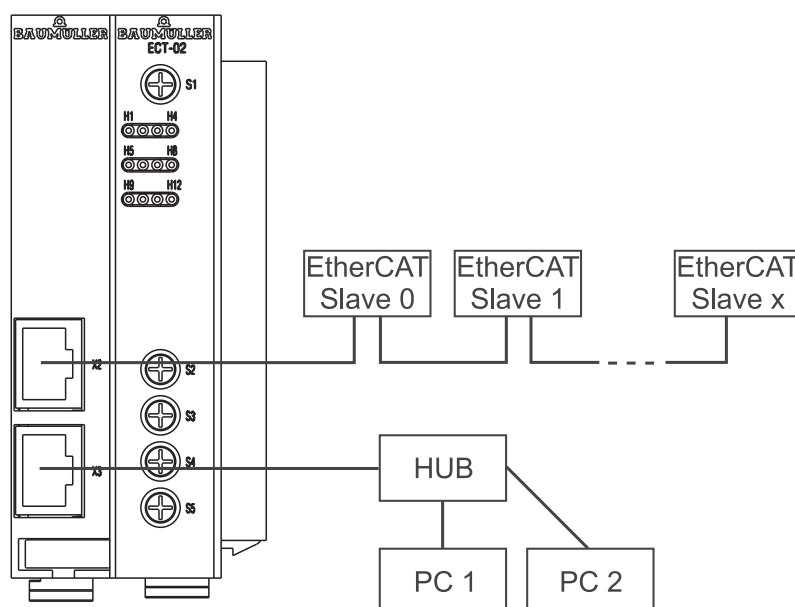

Figure 14: Example of a configuration Ethernet with EtherCAT-Master module

6.4.2 LEDs for displaying operating status conditions

The module for b maXX controller PLC has as display elements twelve LEDs (eleven orange ones (H1, ... H7, H9, ...H12) and one green/red (H8), see „F“ in [►Figure 6◄](#) on page 24).

The LEDs have different meanings during initialization and during operation.

The LEDs H5, H6, H11 and H12 are reserved.

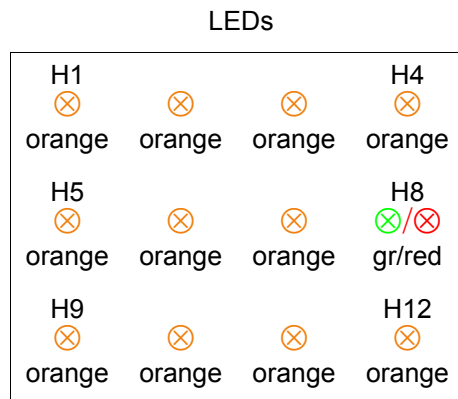

The patterns of the individual LEDs are described below. The flashing patterns are based on the following time scheme:

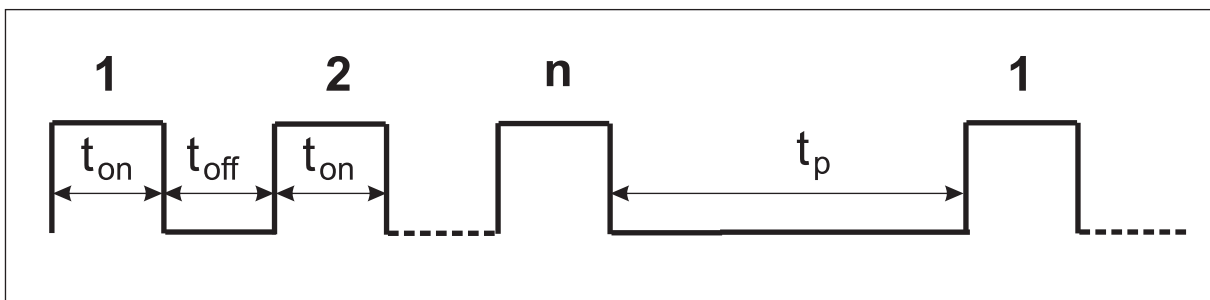

Figure 15: Flashing patterns of the LEDs

6.4.2.1 Activating and initializing

After switching on, the module goes through the initialization stage. This takes approximately 3 seconds. During initialization, the following patterns are displayed:

Pattern	Meaning
H9 (orange) and H10 (orange): 3 s continuous asynchronous flickering	The program is being copied from ROM to RAM

After initialization the module sends the global ready message to the b maXX controller PLC.

6.4.2.2 Operation

The module is ready for operation after approximately 3 seconds.

Module with Ethernet:

Ethernet communication is possible (transmitted to b maXX controller PLC).

Module with EtherCAT:

The b maXX controller PLC can initialize the EtherCAT-Master via Motion Control.

During operation the following LED pattern are possible:

Pattern	Ethernet with EtherCAT-Master	Remedy in the case of errors
H1 (orange):ON H2 (orange):flickering	Ethernet: Operation at 100 Mbps and data traffic is taking place.	
H1 (orange):OFF H2 (orange):flickering	Ethernet: Operation at 10 Mbps and data traffic is taking place.	
H1 (orange):ON H2 (orange):ON	Ethernet: Operation at 100 Mbps. No data traffic.	
H1 (orange):OFF H2 (orange):ON	Ethernet: Operation at 10 Mbps. No data traffic.	
H3 (orange):ON H4 (orange):flickering	EtherCAT-Master: Operation at 100 Mbps and data traffic is taking place.	
H3 (orange):ON H4 (orange):ON	EtherCAT-Master: Operation at 100 Mbps. No data traffic.	
H7 (orange):OFF	EtherCAT-Master - status process data: No process data communication takes place	
H7 (orange):blinking	EtherCAT-Master - status process data: Process data communication is taking place.	
H8 (green): ON	EtherCAT-Master: The master and the network respectively are in "OPERATIONAL" status	
H8 (green): blinking $t_{on} = 200 \text{ ms}$, $t_{off} = 200 \text{ ms}$	EtherCAT-Master: The master and the network respectively are in "PRE-OPERATIONAL" status	

Pattern	Ethernet with EtherCAT-Master	Remedy in the case of errors
H8 (green): blinking $t_{on} = 200 \text{ ms}$, $t_{off} = 1000 \text{ ms}$	EtherCAT-Master: The EtherCAT-Master and the EtherCAT network respectively are in "SAVE-OPERATIONAL" status	
H8 (green): OFF	EtherCAT-Master: The master and the network respectively are in "STOPPED" status	
H8 (green): blinking $t_{on} = 200 \text{ ms}$, $t_{off} = 200 \text{ ms}$, $t_p = 1000 \text{ ms}$, $n = 6$	EtherCAT-Master: The master is in "POWER ON" status and waits for the initialization through the application	
H8 (red): blinking $t_{on} = 200 \text{ ms}$, $t_{off} = 200 \text{ ms}$	EtherCAT-Master: Fatal Error	Carry out a bus diagnosis with ProMaster/ProEtherCAT to determine the cause of fault. Debug the cause of fault and restart the system (or reset the application)
H9 (orange): ON H10 (orange): OFF	Module EtherCAT: Module runs OK	
H9 (orange): ON H10 (orange): ON	Module EtherCAT: Access to flash memory	

To find out how to eliminate the cause of the error, refer to [► Finding and eliminating disturbances ◀](#) from page 43 onward.

6.4.2.3 System errors

System errors are errors that can lead to a system stop of the module. It is very unlikely that a system error will occur; if it does, you must replace the module.

In the case of a system error, it is not possible to communicate via Ethernet, EtherCAT and with the PLC. If a system error of this type occurs, LEDs H9 and H10 indicate this.

The following LED patterns indicate system errors:

Pattern	Ethernet with EtherCAT-Master	Remedy in the case of errors
H9 (orange): OFF H10 (orange): blinking $n = 2$	Processor: TLB miss exception	Replace the module
H9 (orange): OFF H10 (orange): blinking $n = 3$	Processor: general exception	Replace the module

6.4 Description and inspection of the controls and displays

Pattern		Ethernet with EtherCAT-Master	Remedy in the case of errors
H9 (orange): H10 (orange):	OFF blinking n = 4	Processor: undefined IRP	Replace the module
H9 (orange): H10 (orange):	OFF blinking n = 5	Reserved	
H9 (orange): H10 (orange):	OFF blinking n = 6	Processor: Flash error	Replace the module
H9 (orange): H10 (orange):	OFF blinking n = 7	Processor: FPGA error	Replace the module
H9 (orange): H10 (orange):	OFF blinking n = 8	Processor: FPGA error (EtherCAT-Slave only)	Replace the module
H9 (orange): H10 (orange):	OFF blinking n = 9	Processor: MAC address port 0 error	Replace the module
H9 (orange): H10 (orange):	OFF blinking n = 10	Processor: MAC address port 1 error	Replace the module
H9 (orange): H10 (orange):	OFF blinking n > 10	Reserved	

Blinking: $t_{on} = 300 \text{ ms}$, $t_{off} = 300 \text{ ms}$, $t_p = 2 \text{ s}$

6.4.3 Set the module address with rotary switch S1

You set the module address with rotary switch S1. This module address is used to exchange data between the module and the b maXX controller PLC (see [▶Ethernet ◀](#) from page 27 onward in the mounting instructions).

**DANGER**

The following **will occur**, if you do not observe this danger information:

- serious personal injury
- death

Danger from: **mechanical effects**. *At commissioning of the Ethernet with CANopen-Master module, of the b maXX controller PLC and of the connected power supply unit (and other connected system components) with a complete application program can be started the machine/system or parts of the machine/system. Due to a wrong module address the machine/system or parts of the machine/system can behave unexpectedly.*

Keep far enough from the moving parts of the machine/system. Note that from the module and other modules which are connected, machine parts can be set in motion. In all cases, activate the machine's safety devices.

6.4.4 Rotary switches S2/S3

The rotary switches S2 and S3 are reserved.

6.4.5 Set the IP-address for Ethernet with rotary switches S4/S5

Ethernet

You need the rotary switches S4 and S5 to set the IP-address for Ethernet communication (see ▶Application Manual Ethernet with EtherCAT-Master for b maXX controller PLC◀)

Among other things the IP-address can be set by the use of

default address + „rotary switch“ = 192.168.1.“1 + rotary switch“

or by the use of

any address + „rotary switch“ = vv.vv.xxx.yyy.“zzz + rotary switch“.

In the delivery status the default address + „rotary switch“ is set in the module. How to set other IP-addresses see ▶Application Manual Ethernet with EtherCAT-Master for b maXX controller PLC◀.

Values 0 to 31 can set for „rotary switch“.

The values (decimal) 0 to 31 correspond to values (hexadecimal) 0x00 to 0x1F.

The high nibble of the hexadecimal value is set with rotary switch S4 and the low nibble is set with S5.

Example

Value 0x00: Rotary switch S4: 0 Rotary switch S5: 0

Value 0x1F: Rotary switch S4: 1 Rotary switch S5: F

in the example we want to set the IP address 192.168.1.10 (at a module in delivery status). I.e. the rotary switches must be set to 9 or 0x09. Rotary switch S4 is 0 and rotary switch S5 is 9.



Figure 16: Example: Set the Ethernet address 192.168.1.10
(rotary switch S4 to 0, rotary switch S5 to 9)



DANGER

The following **will occur**, if you do not observe this danger information:

- serious personal injury
- death



Danger from: **mechanical effects**. *At commissioning of the Ethernet with CANopen-Master module, of the b maXX controller PLC and of the connected power supply unit (and other connected system components) with a complete application program can be started the machine/system or parts of the machine/system can behave unexpectedly.*

Keep far enough from the moving parts of the machine/system. Note that from the module and other modules which are connected, machine parts can be set in motion. In all cases, activate the machine's safety devices.

6.5 Commissioning sequence

Commissioning is divided into the following procedures:

- 1 Activation.
- 2 Testing the function.



NOTE

Please note the [b maXX controller PLC Operating Instructions](#) and in particular the sequence of commissioning for the b maXX controller PLC described there.

6.5.1 Activation

- Read and observe the [►General safety regulations ◀](#) from page 31 onward.
- You must have carried out correctly section "Assembly and Installation".
- Set switch/pushbutton S1 on the b maXX controller PLC module to "STOP" (center position).
- Switch on the 24 V DC of the power supply unit.



NOTE

You must not connect the Ethernet with CANopen-Master module with the b maXX controller PLC module and/or with other system components or disconnect them, if the 24 V DC power supply is switched on. Switch the 24 V DC power supply off first.

6.5.2 Testing the function

After switching on, the module runs initialization routines. The module is ready for operation after approximately 5 seconds and send the global ready message to the b maXX controller PLC.

The LEDs indicate one of the operating status conditions stated in [►Operation ◀](#) on page 34.

7

OPERATION

For a guide to operating the module for b maXX controller PLC, refer to the Ethernet with EtherCAT-Master for b maXX controller PLC Application Manual and to the b maXX controller PLC Application Manual as well as to the PROPROG wt II Programming Manual and to the Online help system of ProProg wt III.



FINDING AND ELIMINATING DISTURBANCES

In this chapter, we will describe disturbance displays on the module for b maXX controller PLC. We explain the meanings of each disturbance display and how you can respond to them.

8.1 Safety regulations

- ▶ Observe the relevant safety regulations, see ▶ [Basic Safety Instructions](#) ◀ from page 7 onward.

8.2 Requirements of the personnel carrying out work

The personnel who work with the b maXX system, must have been instructed in operating the system and be familiar with correctly operating it. Responding to error displays and status conditions in particular requires special knowledge that operators must demonstrate. Below, we will inform you about the various disturbances and the error messages that result from them. These disturbances can have mechanical or electrical causes.

8.3 Error messages (error list) responses to errors

The module for b maXX controller PLC indicates errors by flashing LEDs H9 (orange), H10 (orange) and H8 (green/red).

A differentiation is made between operating errors and system error.

- Operating errors occur in normal operation and are generally due to operators making wrong configuration settings.

8.3 Error messages (error list) responses to errors

Pattern	Ethernet with EtherCAT-Master	Remedy in the case of errors
H8 (red): blinking $t_{on} = 200 \text{ ms}$, $t_{off} = 200 \text{ ms}$	EtherCAT-Master: Fatal Error	Carry out a bus diagnosis with ProMaster/ProEtherCAT to determine the cause of fault. Debug the cause of fault and restart the system (or reset the application)

- System errors
indicate an internal error in the module. You must replace the module.
(Blinking: $t_{on} = 300 \text{ ms}$, $t_{off} = 300 \text{ ms}$, $t_p = 2000 \text{ ms}$)

Pattern	Ethernet with EtherCAT-Master	Remedy in the case of errors
H9 (orange): OFF H10 (orange): blinking $n = 2$	Processor: TLB miss exception	Replace the module
H9 (orange): OFF H10 (orange): blinking $n = 3$	Processor: general exception	Replace the module
H9 (orange): OFF H10 (orange): blinking $n = 4$	Processor: undefined IRP	Replace the module
H9 (orange): OFF H10 (orange): blinking $n = 5$	Reserved	
H9 (orange): OFF H10 (orange): blinking $n = 6$	Processor: Flash error	Replace the module
H9 (orange): OFF H10 (orange): blinking $n = 7$	Processor: FPGA error	Replace the module
H9 (orange): OFF H10 (orange): blinking $n = 8$	Processor: FPGA error (EtherCAT-Slave only)	Replace the module
H9 (orange): OFF H10 (orange): blinking $n = 9$	Processor: MAC address port 0 error	Replace the module

Pattern	Ethernet with EtherCAT-Master	Remedy in the case of errors
H9 (orange): OFF H10 (orange): blinking n = 10	Processor: MAC address port 1 error	Replace the module
H9 (orange): OFF H10 (orange): blinking n > 10	Reserved	

9

MAINTENANCE

If you comply with the environmental operating conditions specified in [►Appendix D - Technical Data](#) from page 65 onward, the module for b maXX controller PLC is maintenance-free. If you find a defect in your module for b maXX controller PLC or think that it is defective, contact Baumüller Nürnberg GmbH.



10

OVERHAUL

You cannot overhaul a defective module for b maXX controller PLC; contact Baumüller Nürnberg GmbH to obtain a replacement unit.



DISMANTLING, STORAGE

In this chapter, we will describe how you decommission the module for b maXX controller PLC and store it.

11.1 Safety regulations

► Observe the ► [Basic Safety Instructions](#) ◀ from page 7 onward.



CAUTION

The following **may occur**, if you do not observe this caution information:

- property damage.

The danger is: **electrical destruction**. *The sub-assembly may get destroyed electrically if it is removed with the supply voltage on .*

Ensure that all the electrical connections have been deenergized and are secured against re-starting.

Before starting work on the electrical connections, use appropriate measuring equipment to ensure that the connections are dead.

Do not dismount the connections until you are certain that they are dead.



WARNING

The following **may occur**, if you do not observe this warning information:

- serious personal injury
- death

The danger is: **Uncontrollable characteristics of the machine/system**. *Removal of the module with switched on supply voltage can change the characteristics of the machine/system.*

Ensure that all the electrical connections have been deenergized and are secured against re-starting.

Before starting work on the electrical connections, use appropriate measuring equipment to ensure that the connections are dead.

Do not dismount the connections until you are certain that they are dead.

11.2 Requirements of the personnel carrying out work

The personnel that carries out dismantling must have the necessary knowledge and have been trained appropriately to carry out this work. Choose these persons such that they understand and can apply the safety instructions printed on the unit and parts of it and on the connections.

11.3 Dismantling

The personnel who carry out dismantling must meet the requirements above.

The module for b maXX controller PLC is mounted with the b maXX controller PLC, power supply unit and if necessary other system components for b maXX controller PLC.

At dismantling first the module for b maXX controller PLC, the b maXX controller PLC, the power supply unit and if necessary other system components for b maXX controller PLC were disconnected from the 35 mm C profile (and from the I/O-modules right hand for the power supply unit).

Afterwards the b maXX controller PLC module is disconnected from the power supply unit.

The following materials are needed:

- Suitable packing for the Ethernet with EtherCAT-Master module; if possible, use the original packaging material
- Suitable packing for the b maXX controller PLC module; if possible, use the original packaging material
- If necessary suitable packing for the power supply unit; if possible, use the original packaging material
- If necessary suitable packing for other system components for b maXX controller PLC; if possible, use the original packaging material

- Suitable tools for opening the spring energy clamp of the electrical terminal (2-mm wide screwdriver)
- Suitable tools for pulling out the white grip at the bottom of the module (e.g. pointed electronic pliers)

Carry out dismantling in the following sequence:

- 1 Switching the unit free of voltage and securing it from unintended restarting
- 2 Open the control cabinet.
- 3 Remove the cables from the Ethernet with CANopen-Master module.
- 4 Remove the cables from the electrical connection of the power supply unit (see ►Power supply unit for b maXX controller PLC Operating Instructions◄).
Disconnect the spring-loaded terminal (e.g. with 2-mm wide screwdriver) and pull out the respective cable.

- 5** Remove the male connectors from the sockets of the b maXX controller PLC (see [▶ b maXX controller PLC Operating Instructions ◀](#)).
If necessary remove the cables of the other system components mounted on the b maXX controller PLC module (see the according Operating Instructions of these system components).
- 6** There is a white grip on the bottom of power supply unit. Pull the grip (e.g. with the pointed electronic pliers) first downwards and then forward.
The grip locks home.
Repeat this step with the Ethernet with CANOpen-Master module (two grips)
Repeat this step with the b maXX controller PLC module (two grips).
If necessary repeat this step with the other system components for b maXX controller PLC (placed on the left hand of the b maXX controller PLC)

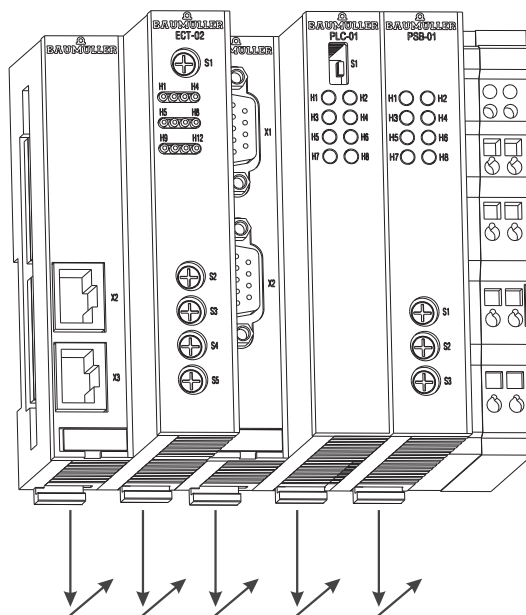

Figure 17: Ethernet with EtherCAT-Master, b maXX controller PLC and power supply unit (white grip)

- 7** Pull the orange grip (e.g. with a screwdriver) on the right hand of the power supply unit forward, so that you can take hold of the grip well.

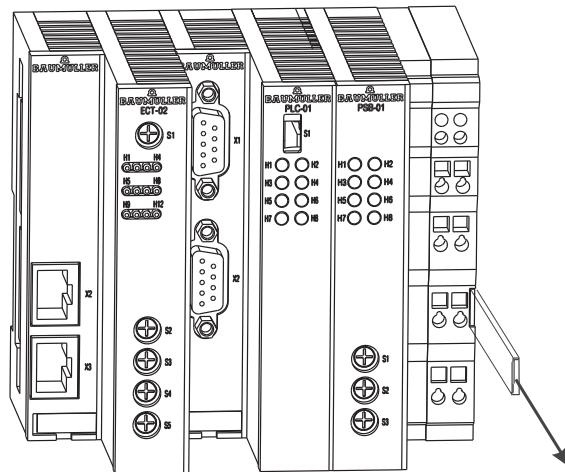

Figure 18: Ethernet with EtherCAT-Master, b maXX controller PLC and power supply unit (orange grip)

- 8 Pull (manually) the orange grip on the right hand of the power supply unit forward and afterwards pull the module block forward from the 35 mm C profile away.
The module block includes the power supply unit, the b maXX controller PLC, the Ethernet with CANopen-Master module and if necessary the other system components for b maXX controller PLC.
- 9 To disconnect the Ethernet with CANopen-Master module from the b maXX controller PLC module (or from the other system components for b maXX controller PLC) press the extraction mechanism on the back of the module with the screwdriver. Insert the screwdriver horizontal in the slot and then press it bottom-up. Now pull the Ethernet with CANopen-Master module out of the b maXX controller PLC module (or out of the other system components for b maXX controller PLC) .
- 10 Place the Ethernet with CANopen-Master module in the prepared packaging.
If necessary place the b maXX controller PLC module in the prepared packaging.
If necessary place the power supply unit in the prepared packaging.
If necessary place the other system components in the prepared packaging.
- 11 If you want to change the Ethernet with CANopen-Master module, mount the new Ethernet with CANopen-Master module now (see [►Assembly and installation ◄](#) from page 21 onward)
- 12 Close the control cabinet.
- 13 Document the dismantling activities carried out (or replacement) of the Ethernet with CANopen-Master module.
If necessary document the dismantling activities carried out (or replacement) of the b maXX controller PLC module.
If necessary document the dismantling activities carried out (or replacement) of the power supply unit for b maXX controller PLC.
If necessary document the dismantling activities carried out (or replacement) of the other system components.

If you changed the Ethernet with EtherCAT-Master module, switch the b maXX system now on. If you want to dispose of the b maXX controller PLC module, refer to chapter [►Disposal ◄](#) from page 55 onward for more information.

11.4 Storage conditions

Store the Ethernet with EtherCAT-Master module for b maXX PLC in suitable packaging according to the storage conditions in [►Appendix D - Technical Data◄](#) from page 65 onward.

11.5 Recommissioning

If you want to recommission the Ethernet with EtherCAT-Master module for b maXX controller PLC, observe the information in "Storage Conditions". Then, carry out [►Commissioning ◄](#) from page 31 onward again.

12

DISPOSAL

In this chapter we will describe how you can correctly and safely dispose of the Ethernet with EtherCAT master module for b maXX controller PLC (BMC-M-ECT-02). Most of the waste is electronic scrap.

- The condition for dismantling has already been met, see [►Dismantling, storage ◀](#) from page 51 onward.

12.1 Safety regulations

You must only carry out disposal in accordance with the safety regulations. If necessary, you must also comply with any local regulations. If you cannot safely dispose of the unit yourself, commission a suitable disposal company to carry it out on your behalf.

12.2 Requirements of the personnel carrying out work

The personnel that carries out disposal/dismantling must have the necessary knowledge and have been trained appropriately to carry out this work. Choose these persons such that they understand and can apply the safety instructions printed on the b maXX system and parts of it.

12.3 Disposal guide

Conditions	<ul style="list-style-type: none">• The Ethernet with EtherCAT-Master module has already been correctly dismantled.• All the necessary technical aids for dismantling are ready for use and are in perfect technical condition.
Sheet steel	The front panel is made of galvanized sheet steel. Dispose of the sheet steel in your local reusable ferrous metal system.
Electronic scrap	You must dispose of the electronic scrap (PCB) that cannot be further dismantled as special waste. When doing this, observe the applicable regulations.
Plastic material	The housing consists of plastic. Dispose of the plastic housing in your local reusable plastic system.

12.4 Disposal locations/official bodies

Ensure that you carry out disposal in accordance with your company's guidelines and with the regulations of the responsible disposal locations and official bodies. If in doubt, contact the Trade Supervisory Authority that is responsible for your company or the Environmental Protection Authorities.



APPENDIX A - ABBREVIATIONS

API	Applications Programming Interface	EPROM	Erasable Programmable Read-Only Memory
ARP	Address Resolution Protocol	ESD	Electrostatic sensitive devices
BACI	Baumüller Component Interface	FTP	File Transfer Protocol
BUB	Ballast unit	HD	Hamming distance
BUC	Baumüller feed/return feed unit	HTML	Hypertext Markup Language
BUG	Baumüller converter basic feed unit	HTTP	Hypertext Transfer Protocol
BUM	Baumüller individual power unit	I/O	Input/Output
BUS	Baumüller power module	ICMP	Internet Control Message Protocol
CAL	CAN Application Layer	IP	Internet Protocol
CAN	Controller Area Network	IRP	Interrupt
CiA	CAN in Automation	ISO	International Organization for Standardization
COB	Communication Object	LAN	Local Area Network
COB-ID	Communication Object Identifier	LED	Light Emitting Diode
CSMA/CD	Carrier Sense Multiple Access / Collision Detection	LSS	Layer Setting Services
CSMA/CA	Carrier Sense Multiple Access / Collision Avoidance	MAC	Media Access Control
CPU	Central Processing Unit	OSI	Open Systems Interconnect
DC	d.c. current	PDD	Process Data Directory
DCF	Device Configuration File	PDO	Process Data Object
DHCP	Dynamic Host Configuration Protocol	PLC	Process Loop Controller (PLC)
DIN	Deutsches Institut für Normung e.V. (German Standards Institute)	RAM	Random Access Memory
DP-RAM	Dual-port RAM	SAP	Service Access Point
DR	Draft Recommendation	SDO	Service Data Object
DS	Draft Standard	SMS	Short Message System
DSP	Draft Standard Proposal	SMTP	Simple Mail Transfer Protocol
EDS	Electronic Data Sheet	PLC	Programmable Logic Controller
EMC	Electromagnetic compatibility	SRD	SDO Requesting Device
EN	European standard	SRDO	Safety Relevant Data Object
		TCP	Transport Control Protocol
		Telnet	Terminal over Network

UDP	User Datagram Protocol
URL	Uniform Resource Locator
VDE	Verband deutscher Elektrotechniker (German Association of Electrical Engineers)
WWW	World Wide Web
16#	Prefix for hexadecimal numbers



APPENDIX B - ACCESSORIES

In this appendix, you will find a list of all the accessories that are available for Baumüller Nürnberg GmbH's Ethernet with EtherCAT-Master module for b maXX controller PLC.

If you have any queries about accessories or suggestions for improvements, Baumüller's Product Management will be pleased to hear from you.

B.1 List of all accessories

B.1.1 EtherCAT cables

Line type: K-ETH-33-0-xx (RJ male connector, RJ male connector):

Type	Length [m]	Article Number
K-ETH-33-0-0,5	0,5	325160
K-ETH-33-0-01	1	325161
K-ETH-33-0-02	2	325162
K-ETH-33-0-03	3	325163
K-ETH-33-0-04	4	325317
K-ETH-33-0-05	5	325164
K-ETH-33-0-10	10	325165

B.1.2 Ethernet cable

Crossover package comprising cross coupling (Art. No. 365463) and Cat5 cable 0.5 m (Art. No. 325160)

Type	Article Number
K-ETH-CROSS-ADAPTER	365464

B.1 List of all accessories

Modular coupling, RJ45 female connector - RJ45 female connector, crossover, Cat5, screened

Type	Article Number
K-ETH-CROSS-KUPPLUNG	365463

Line type: K-ETH-33-0-xx (RJ male connector, RJ male connector)

Type	Length [m]	Article Number
K-ETH-33-0-0,5	0,5	325160
K-ETH-33-0-01	1	325161
K-ETH-33-0-02	2	325162
K-ETH-33-0-03	3	325163
K-ETH-33-0-04	4	325317
K-ETH-33-0-05	5	325164
K-ETH-33-0-10	10	325165

B.1.3 Ferrite

Type	Article Number
Ferritt	00421229



APPENDIX C - DECLARATION OF CONFORMITY

In this section we provide general information about EC directives, the CE symbol and the Declaration of Conformity.

C.1 What is an EC directive?

EC directives specify requirements. The directives are written by the relevant bodies within the EU (which used to be called the EC, and the EEC before that, hence the now illogical term EC directive), and are implemented by all the member countries of the EU in national law. In this way the EC directives guarantee free trade within the EU.

An EC directive only contains essential minimum requirements. You will find detailed requirements in standards, to which references are made in the directive.

C.2 What the CE symbol indicates

a) The CE marking symbolizes conformity to all the obligations incumbent on manufacturers for the product by virtue of the Community directives providing for its affixing.

...

b) The CE marking affixed to industrial products symbolizes the fact that the natural or legal person having affixed or been responsible for the affixing of the said marking has verified that the product conforms to all the Community total harmonization provisions which apply to it and has been the subject of the appropriate conformity evaluation procedures.

...

Council Decision 93/465/EEC, Annex I B. a) + c)

We affix the CE mark to the equipment and to the operating instructions as soon as we have established that we have satisfied the requirements of the relevant directives.

Control systems supplied by the Baumüller Nürnberg GmbH are not concerned of the Low Voltage Directive, because their operating voltage is less than 60 V DC or less than 75 V AC. Therefore a declaration of conformity to 2006/95/EC (Low Voltage Directive) cannot be issued.

The electrical safety and function of the control system will be checked with the harmonized standard EN 61131-2.

With specified application of this Baumüller equipment in your machinery, you can act on the assumption that the equipment satisfies the requirements of 2006/42/EC (machinery directive).

Therefore the equipment is developed and constructed in such a way, that the requirements of the harmonized standard EN 60204-1 can be met by the electrical installation.

Control systems supplied by the Baumüller Nürnberg GmbH satisfy the requirements of 2004/108/EC (EMC Directive) by satisfying the requirements of the harmonized standard EN 61131-2.

To enable you to market your machine within the EU, you must be in possession of the following:

- Conformity mark (CE mark)
- Declaration(s) of Conformity regarding the directive(s) relevant to the machine

C.3 Definition of the term Declaration of Conformity

A Declaration of Conformity as defined by this operating instruction is a declaration that the electrical equipment brought into circulation conforms to all the relevant fundamental safety and health requirements.

By issuing the Declaration of Conformity in this section the Baumüller Nürnberg GmbH declares that the equipment conforms to the relevant fundamental safety and health requirements resulting from the directives and standards which are listed in the Declaration of Conformity.

C.4 Declaration of Conformity

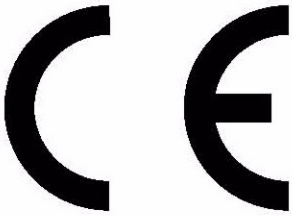
**Konformitätserklärung**

gemäß

- Richtlinie 2004/108/EG (über die elektromagnetische Verträglichkeit)

Hersteller

Baumüller Nürnberg GmbH
 Ostendstr. 80 - 90
 90482 Nürnberg
 Deutschland
 Tel. +49 9 11 54 32 - 0
 Fax: +49 9 11 54 32 - 1 30
 E-Mail: mail@baumueller.de
 Internet: www.baumueller.de

Hiermit erklären wir, dass die nachfolgend genannten Produkte aufgrund ihrer Konzeption, Konstruktion und Bauart in der von uns in Verkehr gebrachten Ausführung den grundlegenden Anforderungen der oben genannten Richtlinie(n) einschließlich der zum Zeitpunkt der Erklärung geltenden Änderungen entsprechen.

Hinweis: Bei Umbau oder Änderungen am Produkt verliert diese Erklärung mit sofortiger Wirkung ihre Gültigkeit.

Angewandte harmonisierte Normen:

- DIN EN 61131-2:2003
 Speicherprogrammierbare Steuerungen – Teil 2: Betriebsmittelanforderungen und Prüfungen

(fortgesetzt)

Declaration of Conformity

according to

- Directive 2004/108/EC (relating to electromagnetic compatibility)

Manufacturer

Baumüller Nürnberg GmbH
 Ostendstr. 80 - 90
 90482 Nürnberg
 Deutschland
 Tel. +49 9 11 54 32 - 0
 Fax: +49 9 11 54 32 - 1 30
 E-Mail: mail@baumueller.de
 Internet: www.baumueller.de

We declare, that the products referred to in the following are conformant in their concept, in their construction and in their design as launched by us with the above mentioned directive(s) and their respective changes which were valid at the point of declaration.

Note: By modifying or altering the device(s) this declaration immediately becomes invalid.

Applied harmonised standards:

- DIN EN 61131-2:2003
 Programmable controller – Part 2: Equipment requirements and tests

(continued)

C.4 Declaration of Conformity

(abgeschlossen)

(finished)

Produkt / Product	Jahr der erstmaligen Ausstellung der CE- Konformitätserklärung Year in that the CE Declaration of Conformity was issued the first time
b maXX [®] Systems BMC-M-ECT-02	2009

Nürnberg, 08. 4. 2009

ppa. Dipl. Ing. Ralf Hopp
Technischer Leiter

ppa. Dr. Ulrich Strunz
Leiter Automation



APPENDIX D - TECHNICAL DATA

In this appendix, you will find the technical data for Baumüller Nürnberg GmbH's Ethernet with EtherCAT-Master module (BMC-M-ECT-02).

D.1 Connection values

BMC-M-ECT-02

Ethernet network types	100BaseTX
Ethernet plug-in connector	1 x RJ45 female connector
EtherCAT network types	100BaseTX
EtherCAT plug-in connector	1 x RJ45 female connector
Operating voltage	+5 V DC internal
Current consumption	500 mA
Ambient conditions	0°C ... 55°C 95% relative humidity, no condensation
Storage conditions	-25°C ... 85°C 95% relative humidity, no condensation
Transport conditions	-25°C ... 85°C 95% relative humidity, no condensation
Protection class	IP 20
Vibration / shock resistance	according to IEC 68-2-6 / IEC 68-2-69
EMC resistance burst / ESD	according to EN 50082 (ESD, Burst) / EN 50081
Dimensions (W x H x D)	38 mm x 100 mm x 91 mm (Width: 46 mm at assembly)
Weight	approx. 175 g
Assembly	on 35 mm C mounting rail according to EN 50022 (named top-hat rail)

D.2 Pin assignment of RJ45 female connector for Ethernet

D.2 Pin assignment of RJ45 female connector for Ethernet

Pin No.	Assignment
1	TX+ (Transmit line +)
2	TX- (Transmit line -)
3	RX+ (Receive line +)
4	Reserved
5	Reserved
6	RX- (Receive line -)
7	Reserved
8	Reserved

D.3 Pin assignment of RJ45 female connector for EtherCAT

Pin No.	Assignment
1	TX+ (Transmit line +)
2	TX- (Transmit line -)
3	RX+ (Receive line +)
4	Reserved
5	Reserved
6	RX- (Receive line -)
7	Reserved
8	Reserved



Revision index

Revision level	State	Modifications
5.06004.016	08.04.2009	Chapter 5.6.4 Ferrite added Appendix C: Declaration of Conformity updated

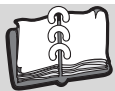

Revision index



Index

Numerics

2004/108/EC	62
2006/42/EC	62
2006/95/EC	61

B

Baumüller	7, 15
BMC-M-ECT-02	5
BMC-PLC-01	5
BMC-PSB-01	5
Board	
defective	49

C

Connection	
electrical	29
Connection cable	29
released	29
Connection diagram	28
Connection values	65
Crossover	
coupling	59

D

Declaration of Conformity	61, 63
Device generation	19
Dismantling	51, 52
Dismantling, sequence	52
Display elements	32
Disposal	55
Disposal guide	55
Disturbance displays	43
Disturbance elimination	43

E

Electrostatic discharge	15
electrical connection	29
EMC Directive	62
Error list	43
Error Messages	43
Ethernet cable	29, 59

F

Finding disturbances	43
Front panel	19

L

LED display	32
Low Voltage Directive	61

M

Machinery directive	62
Maintenance	47
Modultyp	19

O

Overhaul	49
----------	----

P

Personnel	13, 43, 52, 55
qualified	13
Pin assignment	
RJ45 EtherCAT	66
RJ45 Ethernet	66

Q

Qualified Personnel	13, 22
---------------------	--------

R

Recommissioning	54
Responses to errors	43
Responsibility and liability	13

S

Safety regulations	43, 55
Safety regulations, dismantling	51
Sample Configuration	32
Specialist	13
Storage	51
System errors	35

T

Technical Data	65
Terms	
Definition	5
Type Code	
Plug-in module	19

W

Warranty and Liability	14
------------------------	----



Index

be in motion

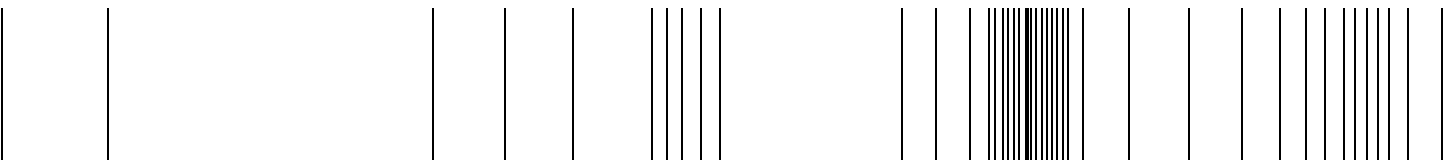

Baumüller Nürnberg GmbH Ostendstraße 80-90 90482 Nuremberg Tel: +49(0)911-5432-0 Fax: +49(0)911-5432-130 www.baumueller.de

All the information in these Operating Instructions is non-binding customer information; it is subject to ongoing further development and is updated on a continuous basis by our permanent change management system. Note that all the data/numbers/information that are quoted are current values at the time of printing. This information is not legally binding for dimensioning, calculation and costing. Before using the information listed in these Operating Instructions as the basis for your own calculations and/or applications, make sure that you have the latest most current information. This means that we accept no responsibility for the accuracy of the information.