

be in motion be in motion

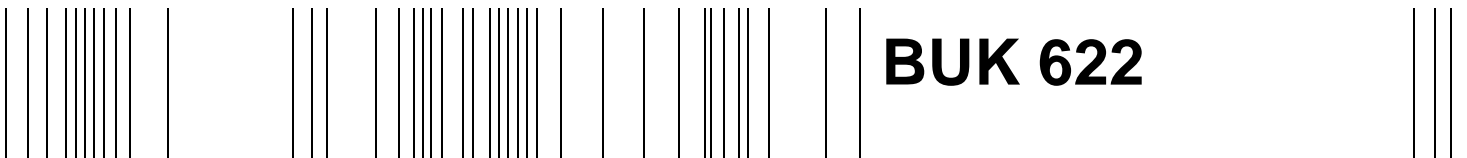

BUK 622

Capacitor unit

Manual

E

5.05010.01



BAUMÜLLER

Title	Manual
Product	BUK 622
Version	5.05010.01
Part no.	396091
Version	20.05.2005
Copyright	<p>These operating instructions may be copied by the owner in any quantity but only for internal use. For other purposes these operating instructions and extracts thereof must not be copied or reproduced.</p> <p>Use and disclosure of information contained in these operating instructions are not permitted.</p> <p>Designations and company marks contained in these operating instructions may be brand names, the use of which by third parties for their own purposes may violate the rights of the holders.</p>
Obligatory	<p>These operating instructions are part of the equipment/machine. These operating instructions must be available to the operator at all times and must be in a legible condition. If the equipment/machine is sold or moved to a different location these operating instructions must be passed on by the owner together with the equipment/machine.</p> <p>After any sale of the equipment/machine this original and all copies must be handed over to the buyer. After disposal or any other end of use this original and all copies must be destroyed.</p> <p>When the present operating instructions are handed over, corresponding sets of operating instructions of a previous version are automatically invalidated. Please notice that specifications/data/information are current values according to the printing date. These statements are not legally binding according to the measurement, computation and calculations.</p> <p>Baumüller Nürnberg GmbH reserves the right, in developing its products further, to change the technical specifications and the handling of the products concerned without prior notice.</p> <p>No liability can be accepted concerning the correctness of the operating instructions unless otherwise specified in the General Conditions of Sale and Delivery.</p>
Manufacturer	<p>Baumüller Nürnberg GmbH Ostendstr. 80 - 90 D-90482 Nürnberg Germany Tel. +49 9 11 54 32 - 0 Fax: +49 9 11 54 32 - 1 30 www.baumueller.de</p>



Table of contents

1	Introduction	5
1.1	Device description BUK 622	5
1.2	First steps	6
1.3	Used terms	6
2	Fundamental safety instructions	7
2.1	Hazard information and commands	8
2.1.1	Safety note structure	9
2.1.2	Form of the hazard sign (triangular or round)	9
2.1.2.1	Hazard information on personal injury	10
2.1.2.2	Hazard information on property damage	15
2.1.2.3	Command signs used	15
2.2	Information sign	16
2.3	Legal instructions	16
2.4	Appropriate use	16
2.5	Inappropriate use	17
2.6	Protective devices	18
2.7	Personnel training	18
2.8	Safety measures in standard operation	18
2.9	Hazards due to residual energy	19
2.10	Disposal of the device	19
2.11	Fire fighting	19
2.12	Responsibility and liability	20
2.12.1	Observing hazard information and safety instructions	20
2.12.2	Hazards when handling this device	20
2.12.3	Warranty and liability	20
3	Transportation and packing	21
3.1	To be considered by transportation	21
3.2	Unpacking	21
3.3	Dispose packing	22
4	Description of the devices	23
4.1	Structure	23
4.2	Interconnect the devices	23
4.3	Overview of hazardous areas	23
4.4	Marking of the device - type key	24
5	Mounting	25
5.1	General safety instructions	25
5.2	Requirements to the executing personnel	26
5.3	Prepare mounting	26
5.4	Installation space	27
5.5	Drilling pattern	28
5.6	Mounting instructions	28
6	Installation	31
6.1	General safety instructions	31
6.2	Requirements to the executing personnel	31
6.3	Requirements to the electrical mains	32



Table of contents

6.4	Requirements to the connecting cables	32
6.5	Protection of the device and of the cable respectively	32
6.6	Requirements on the laying (EMC notes device)	33
6.7	Operating sequence of installation	33
6.8	Connection	34
7	Operation	35
7.1	Safety instructions	35
7.2	Requirements to the executing personnel	36
8	Maintenance	37
8.1	Safety instructions	37
8.2	Environmental conditions	37
8.3	Inspection intervals - maintenance notes	37
9	Repair	39
10	Decommissioning, storage	41
10.1	Safety instructions	41
10.2	Requirements to the executing personnel	41
10.3	Set out of operation	42
10.4	Demounting	42
10.5	Storage conditions	42
10.6	Recommissioning	43
11	Disposal	45
11.1	Safety instructions	45
11.2	Requirements to the executing personnel	46
11.3	Disposal instructions	47
11.4	Recycling plants/offices	47
Appendix A - Abbreviations		49
Appendix B - Spare parts and accessories		51
Appendix C - Declaration by Manufacturer, Declaration of Conformity		53
C.1	What is an EU directive?	53
C.2	What the CE symbol indicates	53
C.3	Definition of the term Declaration of Conformity	54
C.4	Definition of the term Declaration by Manufacturer	54
C.5	Declaration of Conformity	55
C.6	Declaration by Manufacturer	56
Appendix D - Technical data		57
D.1	Required environmental conditions	57
D.2	Cooling	58
D.3	Non-electrical data	58
D.4	Electrical data	58
D.5	Connection cable	59
D.6	Type of protection	59
D.7	Fire fighting appliances	59
Table of figures		61
Index		63
Revision survey		65

INTRODUCTION

This manual is an important component of the **BUK**-device; Please, therefore completely read this manual, before starting operation, last but not least on behalf of your own security.

In this chapter we describe the first steps, which have to be done after you have received the device. Terms will be defined, which are continuously used throughout this manual. You will be informed about duties, which must be considered, when using this device.

1.1 Device description BUK 622

At converter-powered speed current drives, which especially operate as acceleration drives e. g. cross cutter drives, it often is advisable to extend the device-internal DC link capacitor by an external capacitor unit. Therewith the energy, which was regenerated when braking the drive can be stored.

By use of a capacitor unit, it is possible to replace a chopper resistor unit, which normally would convert the regenerated energy into heat. Furthermore it is also used, when the DC link voltage must be maintained in case of a temporary mains failure.

In this manual we will describe the Baumüller device series „**BUK622**“, the connection and the commissioning.

WARNING



The following **can occur**, if you disregard this hazard information:

- serious personal injury
- death

All persons, who work on and with devices, must have this manual available at their work place and must follow the instructions and notes contained therein - especially the safety instructions.

1.2 First steps

- ▶ check the delivery, see [▶Transportation and packing◀](#) from page 21.
- ▶ provide qualified personnel for the mounting, installation and commissioning.
- ▶ hand over this manual to the personnel for mounting, installation and commissioning. Assure that especially the safety instructions are understood and followed.

1.3 Used terms

In this manual we will also use the term „device“ for the Baumüller product „**BUK**“. A list of the abbreviations which are used are to be found in [▶Appendix A - Abbreviations◀](#) from page 49.

2

FUNDAMENTAL SAFETY INSTRUCTIONS

In this chapter we describe the hazards, that can arise when working with the Baumüller-device. Hazards we point up with symbols (icons). All symbols that are used in this manual are listed and explained.

How you can protect yourself against the single hazards in the concrete case, we will not explain in this chapter. In this chapter only general protective measures are specified. Concrete protective measures we will always give directly in the subsequent chapters after the note to the hazard.



WARNING

The following **can occur**, if you disregard this hazard information:

- serious personal injury
- death

The safety note is showing you the hazards which can lead to injury or even to death.

Always follow the safety notes given in this manual.

2.1 Hazard information and commands

Each hazard is classified in one of three different hazard classes. Every hazard class has one of the following characteristic signal words:

DANGER

- serious property damage
- serious personnel injury
- death - **will** occur

WARNING

- serious property damage
- serious personnel injury
- death - **may** occur

CAUTION

- minor to medium personnel injury or
- environmental pollution or
- property damage - **may** occur

2.1.1 Safety note structure

The following two examples show you how the safety notes are constructed. The triangle is used when indicating a hazard for human beings. When there is a circle instead of the triangle, the safety note is only for possible property damage.

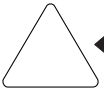

A triangle indicates hazard for human beings. The shade of grey of the outline reflects the severity of the hazard - darker grey means rising hazard.



The icon within the square illustrates the hazard. The outline's shadow of grey reflects the severity of the hazard - darker grey means rising hazard. (Not every safety note has a square representing the hazard, so we have shown it as draft here).



The icon in the circle represents a command. (Not every safety note has a circle representing the hazard, so we have shown it as draft here).



The circle indicates hazard for property.



The icon within the square illustrates the hazard. The outline's shadow of grey reflects the severity of the hazard - darker grey means rising hazard. (Not every safety note has a square representing the hazard, so we have shown it as draft here).

The text beneath the icons is constructed as follows:

HERE STANDS THE SIGNAL WORD WHICH INDICATES THE DEGREE OF THE HAZARD



Here we tell if one or more of the consequences described lower will occur if this safety note is not observed.

- here we describe the possible consequences. The worst consequence stands on the right side.

Here we describe the hazard.

Here we describe what you can do to avoid this hazard.

2.1.2 Form of the hazard sign (triangular or round)

If there is a triangle like  or  or  in front of the signal word, the hazard information is referring to personal damage.

If there is a round hazard signal like  in front of the signal word, the hazard information is referring to property damage.

2.1 Hazard information and commands

2.1.2.1 Hazard information on personal injury

To distinguish each class of hazard information, we use a characteristic outline for both the triangular hazard signs and the square-form icons

For the hazard class **DANGER** the  hazard sign is used. The hazard information of this hazard class used in this documentation is listed below:



DANGER

The following **will occur**, if you do not observe this hazard information:

- serious personnel injury
- death

*The hazard is: **electricity**. Here the hazard may be described in detail.*

Here we describe what you can do to avoid the hazard.



DANGER

The following **will occur**, if you do not observe this hazard information:

- serious personnel injury
- death

*The hazard is: **mechanical influence**. Here the hazard may be described in detail.*

Here we describe what you can do to avoid the hazard.



For the hazard class **WARNING** the warning sign  is used. The following hazard information of this hazard class is used in this documentation.

WARNING



The following **may occur**, if you do not observe this warning information:

- serious personnel injury
- death

*The hazard is: **electricity**. Here the hazard may be described in detail.*



Here we describe what you can do to avoid the hazard.

WARNING



The following **may occur**, if you do not observe this warning information:

- serious personnel injury
- death

*The hazard is: **mechanical influence**. Here the hazard may be described in detail.*



Here we describe what you can do to avoid the hazard.

WARNING



The following **may occur**, if you do not observe this warning information:

- serious personnel injury
- death

*The hazard is: **electro-conductive liquid together with electricity**. Here the hazard may be described in detail.*



Here we describe what you can do to avoid the hazard.



WARNING



The following **may occur**, if you do not observe this warning information:

- serious personnel injury
- death

*The hazard is: **electro-magnetic radiation**. Here the hazard may be described in detail.*



Here we describe what you can do to avoid the hazard.

2.1 Hazard information and commands



WARNING

The following **may occur**, if you do not observe this warning information:

- serious personnel injury
- death



*The hazard is: **liquid coolant**. Here the hazard may be described in detail.*

Here is described what you can do to avoid the hazard.

For the hazard class **CAUTION** the caution sign  is used when there is hazard for persons or of environmental pollution. The following hazard information of this hazard class is used in this documentation.

CAUTION



The following **may occur**, if you do not observe this caution information:

- minor to medium personal injury.

*The hazard is: **hot surface**. Here the hazard may be described in detail.*



Here we describe what you can do to avoid the hazard.

CAUTION



The following **may occur**, if you do not observe this caution information:

- minor to medium personal injury.

*The hazard is: **sharp edges**. Here the hazard may be described in detail.*



Here we describe what you can do to avoid the hazard.

CAUTION



The following **may occur**, if you do not observe this caution information:

- minor to medium personal injury.

*The hazard is: **rotating parts**. Here the hazard may be described in detail.*



Here we describe what you can do to avoid the hazard.

CAUTION



The following **may occur**, if you do not observe this caution information:

- minor to medium personal injury.

*The hazard is: **injury of the eye caused by ricocheting particles**. Here the hazard may be described in detail.*



Here we describe what you can do to avoid the hazard.



CAUTION

The following **may occur**, if you do not observe this caution information:

- minor to medium personal injury.

*The hazard is: **noise**. Here the hazard may be described in detail.*

Here we describe what you can do to avoid the hazard.



CAUTION

The following **may occur**, if you do not observe this caution information:

- minor to medium personal injury.

*The hazard is: **hazard of sliding caused by liquid**. Here the hazard may be described in detail.*

Here we describe what you can do to avoid the hazard.



CAUTION

The following **may occur**, if you do not observe this hazard information:

- environmental pollution.

*The hazard is: **inadequate disposal**. Here the hazard may be described in detail.*

Here we describe what you can do to avoid the hazard.

2.1.2.2 Hazard information on property damage

If there is a round caution sign  in front of the signal word, the safety information refers to property damage.



CAUTION

The following **may occur**, if you do not observe this caution information:

- property damage

*The hazard is: **electro-static discharge**. Here the hazard may be described in detail.*

Here we describe what you can do to avoid the hazard.



CAUTION

The following **may occur**, if you do not observe this caution information:

- property damage

*The hazard is: **damage of the coolant hose**. Here the hazard may be described in detail.*

Here we describe what you can do to avoid the hazard.



2.1.2.3 Command signs used



wear safety gloves



wear safety shoes



wear eye protection



wear ear protection



Use this fire extinguishing agent:
„fire extinguishing agent“

2.2 Information sign



NOTE

This note is a very important information.

2.3 Legal instructions

This documentation is addressed to technical qualified personnel, who is specifically skilled and who is thoroughly familiar with all warnings and maintenance procedures.

The devices are made according to the state-of-the-art technology and they are fail-safe. It can be put into operation and function without problems if you ensure that the information in the manual is complied with.

The user is responsible for the execution of service and commissioning according to the safety instructions of the prevailing standards and other relevant national and local instructions concerning conductor dimensioning and protection, grounding, disconnector, overcurrent protection and so on.

For damages, which result from the mounting or from the connection, the one is liable, who has carried out the mounting or the installation.

2.4 Appropriate use

Always use the device according to the terms. Stated below we have carried a few important notes together. The notes stated below shall give you a feeling for the according to the terms usage of the device. We do not raise any claim for the completion of the notes stated below - follow all instructions given in this manual.

- project the application in such a way, that you always operate the device within its specification.
- use this device only as converter for three-phase drives.
- make sure, that only qualified personnel work with/at this device.
- install this device only on an adequate carrying wall.
- install this device in the way as it is described in the manual.
- make sure, that the mains/power supply unit always applies to the predetermined specifications.
- only operate the device, if it is technical faultlessly.
- operate this device only in combination with released components of the company Baumüller Nürnberg GmbH.
- always operate the device in an area as it is instructed in the „Technical data“.
- operate the device only on low voltage supply systems, that are not used for the supply of buildings in residential areas (according to EN 61800-3, chapter 3.4, 2. environment).
- always operate the device in serialized condition.
Due to safety reasons you must not rebuild the device.

- consider all instructions referring to this, if you intend to store the device.

You are using the device according to the terms, as soon as you regard all notes and information in this operating manual.

2.5 Inappropriate use

In the following we are listing some examples of inappropriate use. The notes mentioned below shall give you a feeling, what a faulty use of the device is. However, we cannot list all possible cases of inappropriate use here. All uses, in which the instructions of this manual are disregarded are inappropriate and therewith forbidden, especially in the following cases:

- You disregarded the notes in this manual.
- The device has not been specifically applied as a converter in order to control a motor.
- The device has been
 - mounted incorrectly,
 - connected incorrectly,
 - commissioned incorrectly,
 - operated incorrectly,
 - mounted, connected, commissioned, operated and/or maintained by not qualified or inadequately qualified personnel,
 - inappropriately maintained or not maintained (also consider the descriptions of the components),
 - overloaded
- operated
 - with defective safety devices,
 - with incorrectly mounted safety devices or without safety devices,
 - with incorrectly working safety- and protection devices,
 - outside the specified environmental conditions.
- You have modified the device.
- You have insufficiently monitored the parts, which are subject to a wearing.
- You have improperly carried out a repair.
- You have combined the device with improper products, which are not enabled for devices described in this manual.
- You have combined the device with faulty and/or faulty documented products of other manufacturers.
- The device has been operated in an explosive environment.

2.6 Protective devices

The devices **BUK 622** fulfill the IP00-degree of protection. By mounting the device into a control cabinet you can raise the protective system.



WARNING

The following **can occur**, if you disregard this hazard information:

- serious personal injury
- death



*The hazard is: **electricity** The device cabinet complies with IP 00.*

Operate the device in a control cabinet, which provides a protection against a direct touching of the devices and fulfills at least the demands of the EN 50178 chapter 5.2.4

2.7 Personnel training



WARNING

The following **can occur**, if you disregard this hazard information:

- serious personal injury
- death

Devices of Baumüller Nürnberg GmbH may only be mounted, installed, operated and maintained by qualified personnel.

Qualified personnel (skilled person) are defined as follows:

Qualified personnel

Authorized electronic engineers and skilled persons of the customer or third persons, who have learned the installation and commissioning of Baumüller drive systems and who are authorized, to put circuits and devices into operation according to the standards of the safety technology, to ground and to label.

Qualified personnel has a training or an instruction due to the local valid standards of the safety technique in maintenance and usage of an adequate safety equipment.

Requirements to the operating personnel

The operating of the drive system must only be executed by persons, who have had a training, who have been instructed and who have been authorized for this.

Troubleshooting, preventive maintenance, cleaning, maintenance and replacing parts are only to be executed by trained personnel or by personnel, who has been introduced in this. These persons must be familiar with the manual and act in accordance with this.

Commissioning and instruction must only be carried out by qualified personnel.

2.8 Safety measures in standard operation

- At the mounting location of the device the applicable safety regulations for the installation have to be considered, in which this device has been installed.
- Provide the device with additional monitoring- and safety devices, in case safety precautions determine this.

2.9 Hazards due to residual energy

Electrical residual energy	After separation of the device of the mains current-led parts, as e.g. power connections may not be touched until the capacitors in the device have been discharged (see „discharge time“ in ►Appendix D - Technical data◄ from page 57. Also pay regard to the instructions on the device. If you have additional capacitors connected to the capacitors at the DC link, the discharging also can last much longer. In this case you must determine the necessary waiting time on yourself or measure if the device is off-circuit.
Mechanical residual energy	The mechanical residual energy is dependent upon the application. Driven parts also rotate/move after disconnection of the mains supply for a certain time. Please, provide adequate safety arrangements.

2.10 Disposal of the device

The accurate disposal of the device is described in [►Disposal◄](#) from page 45.

2.11 Fire fighting



WARNING

The following **can occur**, if you disregard this hazard information:

- serious personal injury
- death



*The hazard is: **Electricity when using a conductive fire fighting device.***



Use the following fire fighting devices:

ABC-Pulver / CO₂

2.12 Responsibility and liability

To be able to work as safe as possible with this device, you must know and follow the hazard notes as well as the safety instructions.

2.12.1 Observing hazard information and safety instructions

In this manual we use visually unified safety instructions, which are intended to prevent from personal injury or damage to property.



WARNING

The following **can occur**, if you disregard this hazard information:

- serious personal injury
- death

All persons, who work with this device, must know and regard the safety notes and the safety instructions in this manual.

Apart from this, any and all persons who work on this device must additionally know and regard to all regulations and instructions, that are valid at the location.

2.12.2 Hazards when handling this device

The device „**BUK**“ was developed and manufactured according to the state-of-the-art technology and in compliance with the valid regulations and standards. It is still possible that hazards can arise during use. An overview of possible hazards is to be found in chapter [►Fundamental safety instructions◄](#) from page 7.

We advise against the acute hazard at the accordant positions in this manual.

2.12.3 Warranty and liability

All information in this manual is non-binding customer information; it is subject to ongoing further development and is updated on a continuous basis by the revision service of Baumüller Nürnberg GmbH.

Warranty- and liability claims against Baumüller Nürnberg GmbH are excluded if in particular one or more of the causes listed in [►Inappropriate use◄](#) from page 17 has/have caused the damage.

TRANSPORTATION AND PACKING

In this chapter we describe, which conditions have to be adhered to at transportation, how you check the device after receipt and what you should have to consider, if you dispose the packing.

3.1 To be considered by transportation

For the first transportation of the device, the device was packed in the manufacturer company. In case you transport the device, assure, that the following conditions are fulfilled during the whole transportation:

- 2 K 3 (climatic category) ¹⁾
- - 30 °C to + 70 °C (temperature range)
- max. 1 g (vibration, shock, repetitive shock)

¹⁾ EN 50178, table 7

3.2 Unpacking

After receipt of the device, which is still packed:

- Avoid strong transportation vibrations and severe hits, e.g. when setting down.
- Check, if transportation damages are visible!

If so:

- Immediately complain to the deliverer. Let the claim be confirmed in writing and immediately contact the substitution of Baumüller Nürnberg GmbH, which is in charge for your company.

WARNING

The following **can occur**, if you disregard this hazard information:

- serious personal injury
- death

*The hazard is: **electricity***

Do not operate the device, if you have recognized a transportation damage or if you assume this. In this case immediately contact Baumüller Nürnberg GmbH



3.3 Dispose packing

If there is no transportation damage recognizable:

- ▶ Open the packing of the device.
- ▶ Check the scope of supply by means of the delivery note.

The minimum scope of supply is:

- **BUK 622**
- this manual inclusively the copy of the declaration of conformity/declaration of manufacturer
- ▶ claim at the Baumüller substitution, which is in charge, in case the delivery is not complete.

3.3 Dispose packing

The packing is made of cardboard, plastics, metal parts, corrugated cardboard and/or wood.

- ▶ Regard the local disposal instructions, in case you dispose the packing.

DESCRIPTION OF THE DEVICES

In this chapter the basic construction of the devices **BUK 622** and the type key on the devices are explained.



NOTE

The devices of the **BUK 622**-series are provided for the operation in the „second environment“ (industrial environment) according to EN 61800-3. In case you operate the device in the „first environment“ (residential area), you perhaps must carry out additional interference procedures.

4.1 Structure

The external capacitor units BUK are in a cabinet of the type series 6 and are available for DC link voltages with 310 V and with 540 V.

Further information is to be in the type key (see [▶Marking of the device - type key◀](#) on page 24).

4.2 Interconnect the devices

The device is part of the Baumüller series 6 and can be combined with other Baumüller devices.

4.3 Overview of hazardous areas

The following overview shows the existing hazard areas on the particular device. Use this survey for an overview of the existing hazard areas, if you incorporate into the handling of this device. The explanation of the symbols, which are used you will find in [▶Hazard information and commands◀](#) from page 8.

4.4 Marking of the device - type key

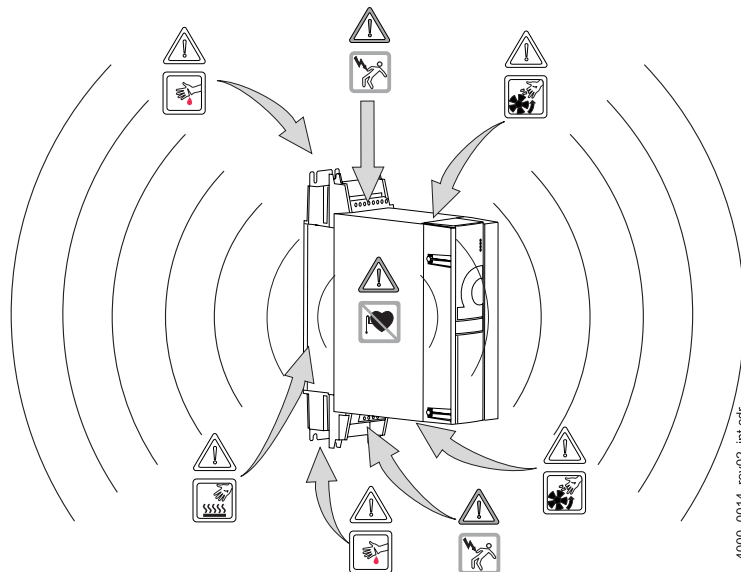

Figure 1: Hazard areas

4.4 Marking of the device - type key

On the type plate (label) you will find, besides others, the type key of the device.



BUK - 622 - 31 - 20 - 000
54 - 05 - 000

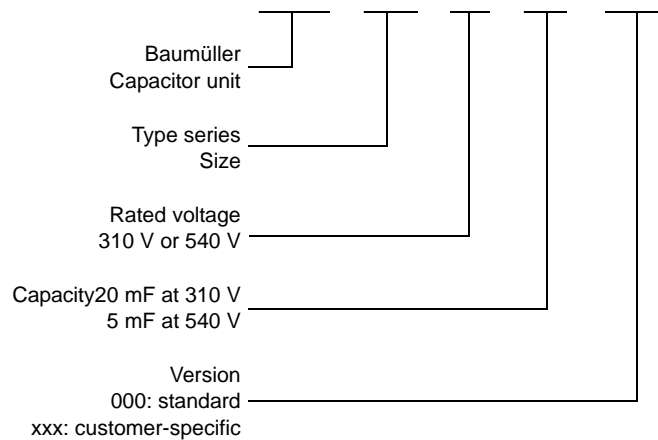

Figure 2: Type key

MOUNTING

In this chapter we describe the mechanical mounting of the device into a control cabinet. Information about the installation space is also to be found in this manual (see [▶Installation space◀](#) from page 27).

Mounting consists of the following steps:

- 1 Prepare mounting (drill holes/cut-out segments)
- 2 Install device

5.1 General safety instructions

- ▶ please regard to the information in chapter [▶Fundamental safety instructions◀](#) from page 7.
- ▶ pay attention to all areas at the device, which could be hazardous for you while mounting. Use this survey only for the mechanical mounting. Hazards, which, for example, result from electricity are not shown here.

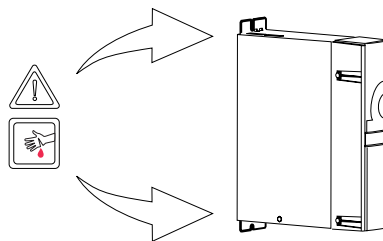

Figure 3: Hazard areas at the mechanic mounting

5.2 Requirements to the executing personnel



CAUTION

The following **may occur**, if you do not observe this safety information:

- minor to medium personal injury.

*The hazard is: **sharp edges**. In case, while installing, you lift a device with unprotected hands, fingers/palm can be cut. If the device falls off, your feet can be cut up.*

Assure, that only qualified personnel, who is familiar with the safety- as well as with the mounting instructions, mount this device.



wear safety gloves



wear safety shoes

Qualified personnel are persons, who have been instructed by the responsible person, based on their training, experience, the instructions they were given as well as their knowledge about relevant standards and instructions, knowledge of the accident prevention instructions and of the company, to carry out the necessary operations and thereby are able to recognize and avoid the hazards which could happen. The required qualifications for the work with this unit are for example:

- Training or instruction due to the standards of safety engineering in maintenance and use of appropriate safety equipment.

5.3 Prepare mounting

You can prepare the mounting with the configuring manual for your installation. With the project manual and the drill figures (see [▶Drilling pattern◀](#) from page 28) you can determine the dimensions for the cut-outs and for the fastening drills.



CAUTION

The following **may occur**, if you do not observe this safety information:

- minor to medium personal injury.

*The hazard is: **Eye injury due to catapulting particles**. While executing the drillings and the cut-out metal particles are catapulted.*



wear eye protection

- Carry out the drillings and if necessary the cut-outs

5.4 Installation space

The following drawings show the main dimensions of the devices in mm. Use these drawings, in order to determine the required space in the control cabinet. For the construction of the necessary drillings/cut-outs use the drawings in [▶Drilling pattern◀](#) on page 28. All dimensions in mm.

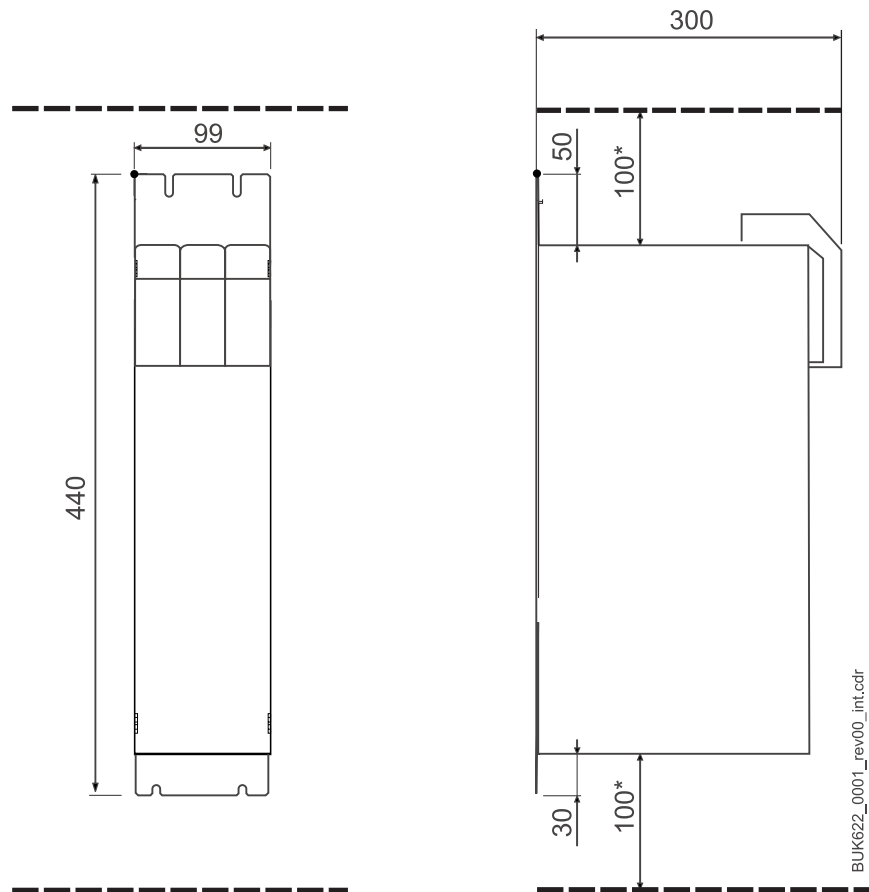

Figure 4: Installation space

*: min. Expansion space, also consider [▶Cooling◀](#) on page 58

5.5 Drilling pattern

The following drawings are showing the drilling patterns of the devices. Use these drawings, to prepare the necessary drillings/cut-outs. Use the drawings under [Installation space](#) from page 27, to determine the required space in the control cabinet.

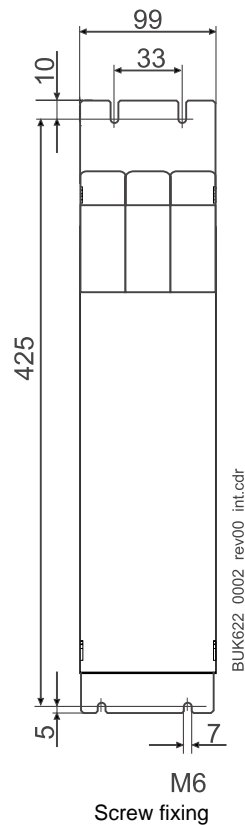

Figure 5: Drilling patterns

5.6 Mounting instructions

Every mounting procedure is shown as a chart (see [Figure 6](#) on page 30). Which screws and washers you need for the particular mounting, is also to be found below the particular chart.

WARNING

The following **can occur**, if you disregard this hazard information:

- serious personal injury
- death

*The hazard is: **mechanical effects**. You can be hurt by the device, if it falls down.*

Transport the device in a way, so that it cannot fall down. Use a suitable lifting means when mounting it.



**CAUTION**

The following **can occur**, if you disregard this hazard information:

- minor to medium personal injury.

*The hazard is: **sharp edges**. In case, while installing, you lift a device with unprotected hands, fingers/palm can be cut. If the device falls off, the feet can be cut.*



wear safety gloves



wear safety shoes

Complete the mounting in the following way:

- 1 provide, if necessary, a suitable transportation-/lift equipment
- 2 provide suitable mounting accessories
- 3 mount the device.

5.6 Mounting instructions

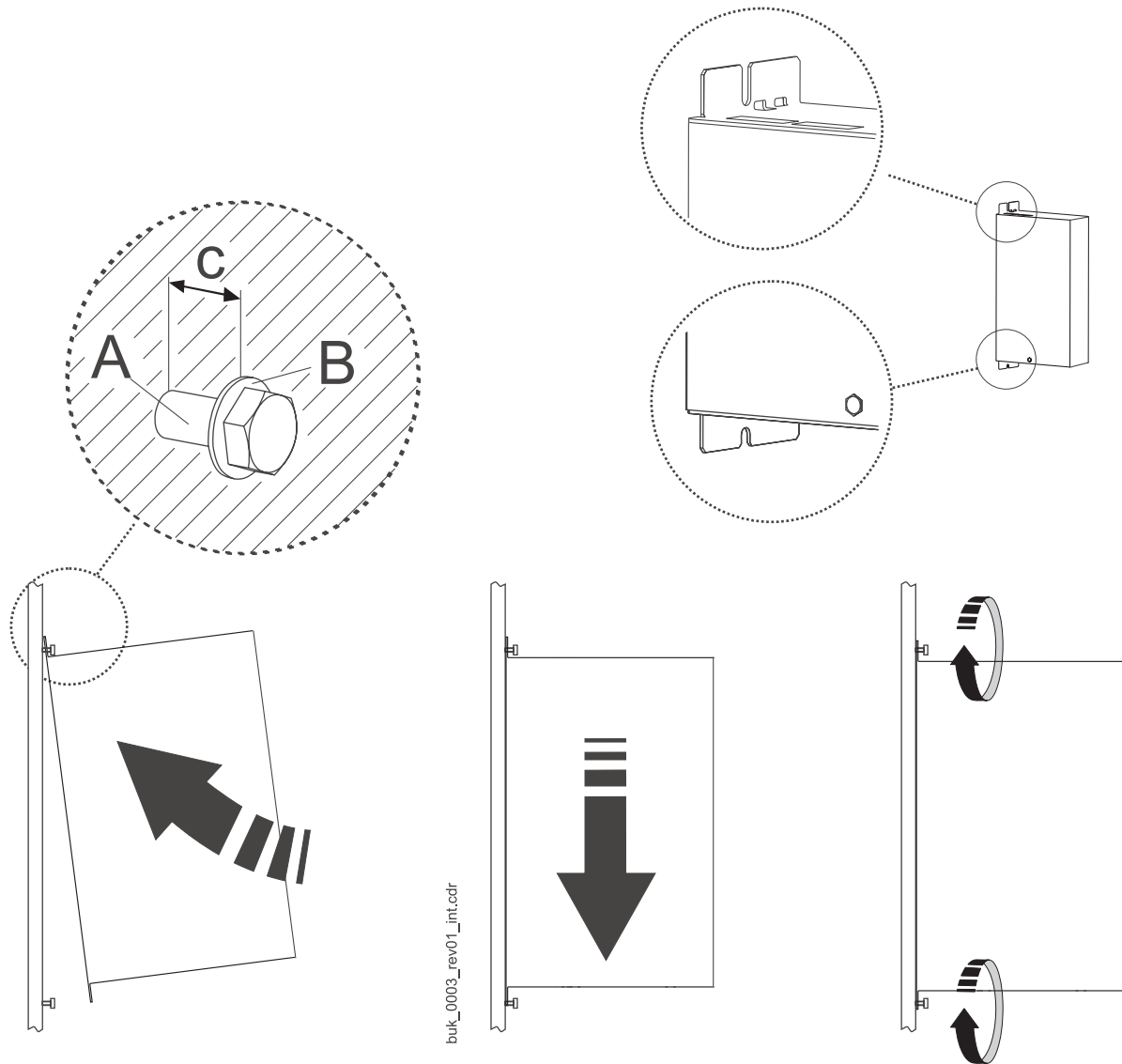

Figure 6: Mounting instruction

A - screws	4 x M6
B - washers	4 x (6.3 x 10)
C - mounting space	c = 5 mm

INSTALLATION

In this chapter we describe the electric installation of the device. The mechanical installation is described in [▶Mounting◀](#) from page 25.

Before installing assure that the technical preconditions are fulfilled:

- 1 Check the requirements to the electrical mains and check if the existing mains is suitable.
- 2 Check the requirements to the electrical cables and provide the according cables.
- 3 Check the characteristics of the terminals and configurate the connections accordingly.

6.1 General safety instructions

- ▶ Pay attention to the information in the chapters [▶Fundamental safety instructions◀](#) from page 7.
- ▶ Pay attention to all areas at the device, which could be hazardous for you during the electrical installation.

6.2 Requirements to the executing personnel



WARNING

The following **can occur**, if you disregard this hazard information:

- serious personal injury
- death



*The hazard is: **electricity** When operating with this electrical unit, inevitably certain parts of this unit are under hazardous voltage.*

Make sure, that only qualified personnel, who are familiar with the safety- as well as with mounting-, operating- and maintenance instructions, work on this unit.

6.3 Requirements to the electrical mains

At each case qualified personnel are persons, who are authorized by the responsible persons, to carry out necessary actions and who recognize the possible hazards and who are able to avoid these hazards. They have had the training, the experience, they were given instructions as well as knowledge about the relevant standards and instructions, they have knowledge of the accident prevention regulations and of the operating environments. The required qualifications for the work with this unit are for example:

- Education or instruction or to have the authorization to put into operation, ground and label circuits and devices according to the standards of safety engineering.
- Training or instruction due to the standards of safety engineering in maintenance and use of appropriate safety equipment.

6.3 Requirements to the electrical mains

All important data is to be found in the appropriate basic unit description. Small deviations of the electrical mains from the requirements can lead to malfunctions of the device. In case the mains deviates strongly from the requirements, the device can be destroyed. The destruction of the device can cause personnel injury.



WARNING

The following **can occur**, if you disregard this hazard information:

- serious personal injury
- death



*The hazard is: **electricity** In case you do not ensure the requirements to the electrical mains, the device can be damaged/destroyed and can thereby hazard persons severely.*

Assure before installation, that the requirements of the electrical mains are fulfilled.

6.4 Requirements to the connecting cables

- When selecting connection cables, you have to consider the IEC/EN 60204-1, chapter 13.
- Use a copper cable for at least 60°C (drives < 3 x 100 A) or 75°C (drives ≥ 3 x 100 A) incase you consider the UL 508 C.

Further information (e. g. maximum allowable length) is to be found in [▶D.5 Connection cable](#) on page 59.

6.5 Protection of the device and of the cable respectively

In order to protect the device or the cables against damage/destruction by the mains, you must install fuses. Data see corresponding basic unit description.

6.6 Requirements on the laying (EMC notes device)



NOTE

The emission of radio interferences is to a high level dependent on the wiring, the volume expansion and the arrangement of the components in the installation. That is why the assurance of the electromagnetic compatibility according to the public rules only is possible on the completed installation and therefore is in the responsibility range of the manufacturer of the installation or of the operating authority (EMVG § 6, sec. 9).

Further notes see basic unit description.

6.7 Operating sequence of installation



WARNING

The following **can occur**, if you disregard this hazard information:

- serious personal injury
- death

*The hazard is: **electricity** Parts, which are under tension are perilous.*



Assure, that during the total mounting, the device, the parts, that are to be mounted (e. g. mains cables) and the mounting range are off-circuit.

Installation exists of the following steps:

- 1 Lay all cables EMC-compatible.
- 2 Connect the accordant basic unit in accordance with the relating manual.
- 3 Connect BUK (see [▶Connection◀](#) on page 34).

6.8 Connection

The BUK must be connected with the DC link of the supply unit.

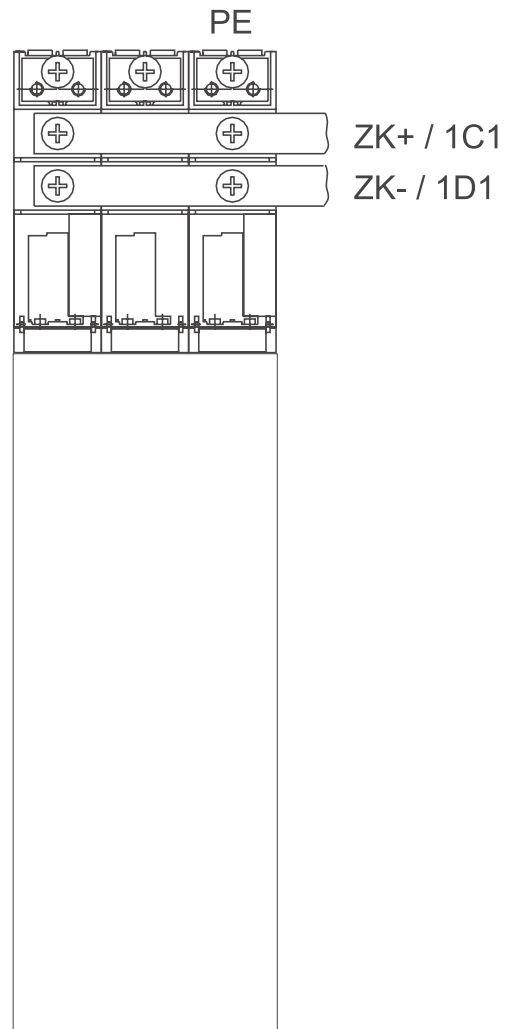

Figure 7: Connection to the DC link

OPERATION

In this chapter we describe, how the device works during operation and how you handle the device during operation.

7.1 Safety instructions

- Refer to the safety instructions from the chapter [Fundamental safety instructions](#) from page 7.



CAUTION

The following **can occur**, if you disregard this hazard information:

- damage to property

*The hazard is: **Environmental conditions, that do not refer to the demands.***

Assure, that the environmental conditions are referred to during operation (see [D.1 Required environmental conditions](#) on page 57).



WARNING

The following **can occur**, if you disregard this hazard information:

- serious personal injury
- death

*The hazard is: **electricity** The control cabinet, in which the device is built in, shall protect against contacts with parts which are under voltage.*

Assure, that during operation all doors of the control cabinet are closed.

Assure, that during operation all safety devices work.

7.2 Requirements to the executing personnel



WARNING

The following **can occur**, if you disregard this hazard information:

- serious personal injury
- death



*The hazard is: **electricity** When operating with this electrical unit, inevitably certain parts of this unit are under hazardous voltage.*

Assure, that only qualified personnel work on this unit.

At each case qualified personnel are persons, who are authorized by the responsible persons, to carry out necessary actions and who recognize the possible hazards and who are able to avoid these hazards. They have had the training, the experience, they were given instructions as well as knowledge about the relevant standards and instructions, they have knowledge of the accident prevention regulations and of the operating environments. The required qualifications for the work with this unit are for example:

- Education or instruction or to have the authorization to put into operation, ground and label circuits and devices according to the standards of safety engineering.
- Training or instruction due to the standards of safety engineering in maintenance and use of appropriate safety equipment.

8

MAINTENANCE

In this chapter we describe, how you can safely maintain your device.

8.1 Safety instructions

- refer to [►Fundamental safety instructions◄](#) from page 7.
- refer to the hazard areas of the devices.

8.2 Environmental conditions

If the prescribed environmental conditions are complied with, the device is maintenance-free. The prescribed environmental conditions are to be found in chapter [►Appendix D - Technical data◄](#) from page 57. The most important prescribed environmental conditions are:

- Dustless ambient air
- Temperature: min. 5 °C to max. 55 °C
- Relative air humidity: 5 % to 85 %, no condensation
- (Operational-) height: absolute altitude up to 2000 m

8.3 Inspection intervals - maintenance notes

Baumüller Nürnberg GmbH recommends a steady checking of the environmental conditions. Thus you will receive the possibility, to react immediately, in case the actual conditions deviate from the prescribed conditions.



WARNING

The following **can occur**, if you disregard this hazard information:

- serious personal injury
- death



*The hazard is: **electricity** The unit carries hazardous voltages and currents, as well as residual charges in the DC-link.*

Assure, that when working in the control cabinet, that all devices in the control cabinet are off-circuit and are safe against re-starting.

Await the discharge of the DC-link, before you install the safety relay. The capacitors which are used in the device are **10 min.** after interruption of the supply voltage automatically discharge so far, that the terminals can be demounted without hazard. If you have additional capacitors connected to the DC-link, the discharging also can last much longer. In this case you must determine the necessary waiting time yourself and you must control the de-energization at all terminals of the device (also see [►Hazards due to residual energy◄](#) on page 19).

- At least once a day check the equipment at the control cabinet, which ensure the required environmental air (e.g. air filters)
- Maintain the air filters according to the indications of the manufacturer.

In the case of polluted environmental air, the required cooling air rate can not be reached anymore, if dirt deposits narrow/block up the ventilation slots. If the devices are dirty, contact Baumüller Nürnberg GmbH, in order to initiate a servicing or send the device to the company for inspection.



WARNING

The following **can occur**, if you disregard this hazard information:

- serious personal injury
- death



*The hazard is: **electricity** The device can be damaged by incorrect maintenance in such a way, that a safe operating isn't possible anymore.*

Do not maintain the device yourself.

Never remove dirt deposits especially in the inside of the device with sharp objects like screwdrivers or by the usage of e. g. compressed air, steam jet appliances/high pressure cleaners.

REPAIR

In this chapter we describe, where the devices are repaired.

WARNING



The following **can occur**, if you disregard this hazard information:

- serious personal injury
- death



*The hazard is: **electricity** After a faulty repair the device doesn't fulfill the safety instructions anymore.*

Have the devices repaired only by the Baumüller Nürnberg GmbH or by authorized service points.



DECOMMISSIONING, STORAGE

In this chapter we describe, how you decommission and store the device.

10.1 Safety instructions

- refer to [►Fundamental safety instructions◄](#) from page 7 and the information in [►Transportation and packing◄](#) from page 21.

The shutdown of the device may only be carried out by for this qualified personnel.



DANGER

The following **will occur**, if you do not observe this safety note:

- serious personal injury
- death

*The hazard is: **Electricity and electrical charge, which was stored.** Electrical connections, which are not switched current-free, carry hazardous voltage. The modules in the device (e. g. capacitors) can, also after switch-off, contains hazardous charges!*

Assure, when working in the control cabinet, that all electrical terminals in the control cabinet are off-circuit and are safe against re-closure.

Before working, check at the electrical connections with suitable measuring devices, that the connections are off-circuit.

Remove the connections not until you have verified yourself of the isolation from supply.

If you have additional capacitors connected to the DC-link, the discharging also can last much longer. In this case you must determine the necessary waiting time self (also see [►Hazards due to residual energy◄](#) on page 19).

10.2 Requirements to the executing personnel

The personnel, who is appointed to setting out of operation, must have the required knowledge and instructions, which is necessary for an execution according to the rules. Select the personnel in such a way, that the safety instructions, which are mounted to the device and its parts as well as to the terminals, are understood and applied to.

10.3 Set out of operation

Carry out the setting out of operation as follows:

- 1 Put the device off-circuit and assure the device against unintentional re-closing.
- 2 Verify the isolation from supply of all connections (soonest 10 minutes after switching off).
- 3 Demount the connections and protect the connections according to the safety instructions.
- 4 Document the setting out of operation.

10.4 Demounting

The demounting assumes a completed, documented setting out of operation.



CAUTION

The following **can occur**, if you disregard this hazard information:

- minor to medium personal injury.

If during mounting you lift a device with unprotected hands, your fingers/palm can be cut. If the device falls off, your feet can be cut up.



wear safety gloves



wear safety shoes

- 1 Secure the device against falling off/out.
- 2 Enable all mechanical connections
- 3 Lift the device out of the control cabinet.
- 4 Store the device in a suitable packing.
- 5 At transportation pay attention to, that the device is not damaged by wrong storage or severe shocks, also see [▶To be considered by transportation◀](#) on page 21.

In case you want to dispose the device, you will find in chapter [▶Disposal◀](#) from page 45 further information.

10.5 Storage conditions

The device is maintenance-free. If you keep to the environmental conditions during the entire period of storage, you can assume, that the device will not be damaged. In case the environmental conditions during storage are not kept, you should assume that the device is damaged after storage.

**CAUTION**

The following **may occur**, if you do not observe this safety information:

- damage to property

*The hazard is: **incorrect environmental conditions**. Incorrect storage can damage/destroy the device.*

Assure, that the environmental conditions are kept during the entire period of storage:

- Climatic category 1 K 4
- Temperature range - 30 °C to + 70 °C

*The hazard is: **recommissioning without reforming of the capacitors**. From six months storage period on, the capacitors are destroyed during commissioning, if they are not reformed beforehand.*

- Form the capacitors by supplying the device ready-for use for at least 48 hours with supply voltage, but do not transmit an pulse enable.

10.6 Recommissioning

Carry out commissioning as with a new device, see
[►Mounting◄](#) from page 25, [►Installation◄](#) from page 31.

11

DISPOSAL

In this chapter we describe the correct and safe disposal of the devices of the series **BUK**. During the disposal you will mainly get metal parts (iron- and non-iron metal), electrical scrap and plastics.

NOTE



Baumüller products do not belong to the scope of the EU guideline for the disposal of electrical and electronics devices (WEEE, 2002/96/EG). Therefore, no costs are to be carried by Baumüller for the canceling and disposal of old devices.

11.1 Safety instructions

► refer to ► [Fundamental safety instructions](#) ◄ from page 7.

HAZARD



The following **will occur**, if you do not observe this safety note:

- serious personal injury
- death



*The hazard is: **electricity**. The containing components in the device (e. g. capacitors) can contain hazardous charges!*

If you have connected capacitor unit to the DC link, DC link decharging can last much longer. In this case you must determine the necessary waiting time self (also see ► [Hazards due to residual energy](#) ◄ on page 19).

Demount the capacitors only then, if you have verified yourself of the isolation from supply.

11.2 Requirements to the executing personnel



CAUTION

The following **can occur**, if you disregard this hazard information:

- minor to medium personal injury.

*The hazard is: **sharp edges**.* The components of the device, sheet metal components, heat sinks and so on can have sharp edges!

In case you lift a device during demounting with non-protected hands, your fingers/palms can be cut. If the device falls off, your feet can be cut up.



wear safety gloves



wear safety shoes



CAUTION

The following **may occur**, if you do not observe this safety information:

- Environmental pollution

*The hazard is: **incorrect disposal**.*

You may only dispose under consideration of the safety instructions. If necessary, also refer to the local regulations. In case you cannot carry out a secure disposal, contact a certified disposal business.

During a fire hazardous materials may be generated or set free.

Do not expose electronic components to high temperatures.

The inner insulation e. g. various power semiconductors hold beryllium oxide. When opened, the beryllium dust is hazardous to your health.

Do not open the electronical components.

11.2 Requirements to the executing personnel

The personnel which you instruct to dispose/demount the device must have the knowledge and training to carry out these works properly. The personnel is to be selected in such a way, that the safety instructions on the device and its parts is understood and referred to by the personnel.

11.3 Disposal instructions

Preconditions	<ul style="list-style-type: none"> • The device has already properly been demounted. • All technical appliances are prepared and are in a faultlessly condition.
Sheet steel	Sheet steel must be given to the iron metal recycling.
Aluminium	Aluminium must be given to the non-iron metal recycling.
Aluminium/copper compound	Aluminium/copper compound must be given to the non-iron metal recycling.
Plastics	The plastic parts of the housing as well as the plastic covers and further small plastic parts must be given to the plastics recycling.

CAUTION



The following **may occur**, if you do not observe this safety information:

- Environmental pollution

*The hazard is: **incorrect disposal.***



Capacitors, semiconductor modules and electronic scrap is to be recycled as special waste.

Capacitors	Capacitors are to be recycled as special waste. Thereby refer to the relevant instructions.
Semiconductor modules	Semiconductor modules are to be recycled as special waste. Thereby refer to the relevant instructions.
Electronic scrap	The electronic scrap from PCBs, which no further can be demounted, must be recycled as special waste. Thereby refer to the relevant instructions.

11.4 Recycling plants/offices

Assure, that the disposal is carried out according to your company's regulations and the regulations of the disposal companies and official administrations. In case of doubt, contact the local business administration, which is responsible for your company or the environmental office.



APPENDIX A - ABBREVIATIONS

A	Ampere	ENC	Function module incremental encoder
AC	Alternating current	ESD	Electrostatic discharge
AM	Asynchronous motor	EXT, ext	external
ASCII	American Standard Code for Information Interchange	FI	Residual current
BACI	Baumüller drives communication interface	HLG	Ramp function generator
BB	Ready-to-operate	HS	Main contactor
BBext	Ready to operate (external)	HSE	Main contactor on
BBint	Ready-to-operate (internal)	HSF	Main contactor enable
BEDAS	Operating data storage	î	Peak current, curve shape not defined
BSA	Reference potential analog	I2t	Function module overload monitoring
BSD	Reference potential digital	I_{AC}	RMS, alternating current
BUC	Baumüller converter supply/feedback unit	I_{Aist}	Armature current actual value
BUG	Baumüller converter basic-supply-unit	I_{DC}	RMS, direct current
BUK	Baumüller capacitor unit	ID-no.	Identification number
BUM	Baumüller converter single-power-unit	I_{eff}	Effective value, alternating current
BUS	Baumüller converter servo-power-unit	I_F	Field current
CAN	Network for controller ambience	I_{FMax}	Maximum field current (nominal current)
CPU	Central processing unit	I_{Fmin}	Minimum field current
DC	Direct current	I_{Fsoll}	Field current setpoint
DIN	Deutsches Institut für Normung e.V. (German Institute for Standardization)	Inc	Counting unit of position
DSV	Data set manager	Ink	ppr count of incremental encoder
EDS	Electronic data sheet	ISO	International Organization for Standardization
EMF	Electromotive force	I_{soll}	Armature current setpoint
EMC	Electromagnetic compatibility	LT	Power unit
EN	European standard	M24	Reference potential 24 V
		MR1	Torque direction 1
		MR2	Torque direction 2

n = 0	Speed = 0
n_{ist}	Speed actual value
n_{Max}	Maximum speed
n_{min}	Minimum speed
NN	Altitude over sea level
n_{soll}	Speed setpoint
PE	Protective conductor/ Protective conductor connection
PELV	Protective extra-low voltage with safety separation, grounded
PSI	Program Storage Interface
PZD	Process data
R_A	Armature resistance
RF	Controller enable
SELV	Safety extra-low voltage with safe- ty separation
SM	Synchronous motor
SW	Setpoint, software
TM	Motor temperature sensor
U	Voltage
Ū	Peak voltage
U_A	Armature voltage
U_{AC}	Rms, alternating voltage
U_{DC}	Rms, direct-current voltage
U_{eff}	Effective value, alternating voltage
U_{ZK}	DC-link voltage
V	Volt
VBG	German Ministerial Occupation Co-operative
VDE	Association for Electrical, Elec- tronic & Information Technologies
VE	Logic element
ZK	DC-link



APPENDIX B - SPARE PARTS AND ACCESSORIES

In this appendix we are listing the spare-/accessory parts for the devices. In case you have questions and suggestions according the accessories, do not hesitate to contact our product management.





APPENDIX C - DECLARATION BY MANUFACTURER, DECLARATION OF CONFORMITY

In this section we provide general information about EU directives, the CE symbol and the Declaration of Conformity/by Manufacturer.

C.1 What is an EU directive?

EU directives specify requirements. The directives are written by the relevant bodies within the EU and are implemented by all the member countries of the EU in national law. In this way the EU directives guarantee free trade within the EU.

An EU directive only contains essential minimum requirements. You will find detailed requirements in standards, to which references are made in the directive.

C.2 What the CE symbol indicates

a) The CE marking symbolizes conformity to all the obligations incumbent on manufacturers for the product by virtue of the Community directives providing for its affixing.

...

b) The CE marking affixed to industrial products symbolizes the fact that the natural or legal person having affixed or been responsible for the affixing of the said marking has verified that the product conforms to all the Community total harmonization provisions which apply to it and has been the subject of the appropriate conformity evaluation procedures.

...

Council Decision 93/465/EEC, Annex I B. a) + c)

We affix the CE mark to the equipment and to the documentation as soon as we have established that we have satisfied the requirements of the relevant directives.

All converters and control systems supplied by the Baumüller Nürnberg GmbH satisfy the requirements of 73/23/EEC (Low Voltage Directive).

As all converters and control systems comply with the requirements of the harmonized standards EN50178, EN 60204-1, EN 60529 and HD625.1 S1, the protection targets of 73/23/EEC are reached.

With specified application of this Baumüller equipment in your machinery, you can act on the assumption that the equipment satisfies the requirements of 98/37/EG (machinery directive). Therefore the equipment is developed and constructed in such a way, that the requirements of the harmonized standard EN 60204-1 can be met by the electrical installation.

Compliance with 89/336/EEC (EMC Directive) depends on how the equipment is installed. Since you are performing installation yourself, it is you who are responsible for complying with 89/336/EEC.

A declaration of conformity on the EMC directive therefore cannot be issued.

We will provide you with support in the form of EMC information. You will find this information in the operating manual and in “filters for main applications”. When you have complied with all the requirements we impose in this documentation, you can assume that the drive satisfies the requirements of the EMC Directive.

The limit values and requirements for variable-speed electrical drives are determined in the harmonized product standard EN61800-3. If you are erecting an installation, for which a declaration of conformity on the EMC directive must be generated, it may be necessary to specify several harmonized standards, which you have used for the compliance of the protection targets of the directive. The harmonized product standard EN 61800-3 has to be used with electrical drives.

To enable you to market your machine within the EU, you must be in possession of the following:

- Conformity mark (CE mark)
- Declaration(s) of Conformity regarding the directive(s) relevant to the machine

C.3 Definition of the term Declaration of Conformity

A Declaration of Conformity as defined by this documentation is a declaration that the electrical equipment brought into circulation conforms to all the relevant fundamental safety and health requirements.

By issuing the Declaration of Conformity in this section the Baumüller Nürnberg GmbH declares that the equipment conforms to the relevant fundamental safety and health requirements resulting from the directives and standards which are listed in the Declaration of Conformity.

C.4 Definition of the term Declaration by Manufacturer

A Declaration by Manufacturer as defined by this documentation is a declaration that the machine/safety component brought into circulation conforms to all the relevant fundamental safety and health requirements.

By issuing the Declaration of Conformity in this section the Baumüller Nürnberg GmbH declares that the equipment conforms to the relevant fundamental safety and health requirements resulting from the directives and standards which are listed in the Declaration of Conformity .

The Baumüller equipment is integrated into a machine. For health and safety, of the users for example, it is important for the entire machine to conform to all the relevant fundamental safety and health requirements. For this reason the Baumüller Nürnberg GmbH draws attention in the Declaration by Manufacturer to the fact that it is prohibited to put the machine as a whole into operation before it has been declared that the machine conforms to the provisions of the Machinery Directive.

C.5 Declaration of Conformity

EU-Konformitätserklärung

Declaration of Conformity

gemäß EG-Richtlinie 73/23/EWG (Niederspannung) vom 19.02.1973
geändert durch: 93/68/EWG vom 22.07.1993

in accordance with EC directive 73/23/EWG (low voltage) dated 19.02.1973
changed by: 93/68/EWG dated 22.07.1993

Kondensator-Einheit

BUK-622-31-20-XXX

BUK-622-54-05-XXX

Das obige Gerät wurde entwickelt und konstruiert sowie anschließend gefertigt in alleiniger Verantwortung von:

The unit specified above was developed and constructed as well as manufactured under liability of:

Baumüller Nürnberg GmbH, Ostendstr. 80 - 90, D-90482 Nürnberg

Berücksichtigte Normen - used standards:

Norm / standard

EN 50178	Ausrüstung von Starkstromanlagen mit elektrischen Betriebsmitteln Electronic equipment for use in power installations
EN 60204-1	Sicherheit von Maschinen - Elektrische Ausrüstung von Maschinen Safety of machinery - Electrical equipment of machines
EN 60529	Schutzarten durch Gehäuse (IP Code) Degrees of protection provided by enclosures (IP Code)
HD 625.1 S1	Isolationskoordination für elektrische Betriebsmittel in Niederspannungsanlagen Insulation coordination for equipment within low-voltage systems

Nürnberg, 23.05.2005

Andreas Baumüller
Geschäftsführer
Head Division

Dr. Peter Heidrich
Entwicklungsleiter
Head of development

C.6 Declaration by Manufacturer

EU-Herstellererklärung

Declaration by Manufacturer

gemäß EU-Richtlinie 98/37/EG (Maschinen) vom 22.06.1998
geändert durch: 98/79/EG vom 27.10.1998

in accordance with EC directive 98/37/EG (machinery) dated 22.06.1998
changed by: 98/79/EC dated 27.10.1998

Kondensator-Einheit

BUK-622-31-20-XXX

BUK-622-54-05-XXX

Die Inbetriebnahme der Maschine, in die dieses Gerät eingebaut wird, ist untersagt bis die Konformität der Maschine mit der obengenannten Richtlinie erklärt ist.

The machinery into which this unit is to be incorporated must not be put into service until the machinery has been declared in conformity with the provisions of the directive mentioned.

Bei der Entwicklung und Konstruktion des Geräts wurden folgende Normen beachtet:
The development and construction of the unit is complied with following standards:

Norm / standard

EN 60204-1	Sicherheit von Maschinen - Elektrische Ausrüstung von Maschinen Safety of machinery - Electrical equipment of machines
------------	---

Baumüller Nürnberg GmbH, Ostendstr. 80 - 90, D- 90482 Nürnberg

Nürnberg, 23.05.2005



Andreas Baumüller
Geschäftsführer
Head Division



Dr. Peter Heidrich
Entwicklungsleiter
Head of development



APPENDIX D - TECHNICAL DATA

In this chapter you will find the detailed technical data for **BUK 622**.

D.1 Required environmental conditions

Transportation temperature range	- 30 °c to + 70 °c
Transportation climatic category	2 K 3 ¹⁾
Storage temperature range	- 30 °c to + 70 °c
Storage climatic class	1 K 4 ¹⁾
Operational environment	outside of residential areas ²⁾
Operation temperature range	min. 5 °C to max. 45 °C ³⁾
Operation climatic class	3 K 3 ¹⁾
Mounting height	absolute altitude up to 2000 m
Relative humidity (operation)	5 % to 85 % no condensation ¹⁾
Ionized and non-ionized radiation	< measurable area
Vibration, shock and repetitive shock	max 1 g ⁴⁾
Degree of pollution	2 ⁵⁾
Environmental conditions (EN 60721-3-3)	3 K 3, 3 B 1, 3 C 3 except salt fog, 3 S 2, 3 M 3

¹⁾ EN 50178, table 7

²⁾ At usage in residential areas, stringent limit values for the electromagnetic emission are valid. Additionally, filter measures may be necessary.

³⁾ Rated temperature = 40° C

⁴⁾ EN 50178, chapter 9.4.3.2

⁵⁾ EN 50178, table 2

D.2 Cooling

D.2 Cooling

Cooling air temperature ¹⁾	min. 5 °C to max. 45 °C ²⁾
---------------------------------------	---------------------------------------

¹⁾ Air temperature in the entire suction area of the device.

²⁾ Rated temperature = 40° C

D.3 Non-electrical data

Device	Dimensions (W x H x D)	Weight
BUK 622 -31 -54	99 x 360 x 300 mm	4 kg

D.4 Electrical data

	BUK 622-31	BUK 622-54
DC link capacity	20 mF	5 mF
DC link capacity, permitted	See accordant basic unit description	
DC link rated voltage ¹⁾ (U _{DC})	310 V _{DC}	540 V _{DC}
max. DC link voltage ¹⁾ (U _{DC})	400 V _{DC}	800 V _{DC}
Charging current limit	via basic unit (varying, according to series of type, see accordant basic unit description)	
DC link discharging time (internal DC link capacity)	t > 10 min	
permissible DC link charging time per capacitor unit	t > 1 s	

Calculation:

Energy storage capacity during braking operation

$$W_{el} = \frac{1}{2} \cdot C \cdot (U_2^2 - U_1^2)$$

U₁ = DC link voltage before the braking operation

U₂ = DC link voltage after braking operation

This results in the following buffer capacity when braking:

BUK 622 - 31 - 20: approx. 640 Ws (U₁ = 310 V, U₂ = 400 V)

BUK 622 - 54 - 5: approx. 870 Ws (U₁ = 540 V, U₂ = 800 V)

D.5 Connection cable

Device	Cross section ¹⁾	maximum length
Series of type 2/20	10 mm ²	with a short cable
Series of type 3	4 mm ²	
BM44XX	4 mm ²	

¹⁾ Possible cross section
 For UL conform machines/installations you must use UL certified circuit cables.

D.6 Type of protection

Type of protection	IP 20
--------------------	-------

D.7 Fire fighting appliances

Fight fire with	ABC-Pulver
-----------------	------------



Table of figures

Hazard areas	24
Type key.....	24
Hazard areas at the mechanic mounting	25
Installation space	27
Drilling patterns	28
Mounting instruction	30
Connection to the DC link	34



Table of figures



Index

Numerics

73/23/EWG 53

A

Accessories 51

C

Cable

EMC instructions 33

Cables

laying 33

Class of protection 18

Connecting cable 32

Construction of the devices 23

Control cabinet 35, 38

D

DC link 38

Declaration by Manufacturer 53, 56

Declaration of Conformity 53, 55

Decommissioning 41

Demounting 42

Device description 23

Discharge 38

Disposal 45

Disposal instructions 47

Drilling patterns 28

E

Electrical data 58

EMC instructions 33

Environmental conditions 35, 37, 57

Environmental temperature 57

F

Fire fighting 19

First steps 6

Fuses 32

H

Hazard areas 23, 37

Hazard information 20

Hazards 7, 20

I

IEC 60204-1 32

Inappropriate use 17

Inspection intervals 37

Installation 31

electrical mains 32

preconditions 31

Installation space 25, 27

Interconnect the devices 23

Introduction 5

Isolation from supply 41

L

Laying 33

Legal instructions 16

Low Voltage Directive 53

M

Maintenance 37

Maintenance notes 37

Marking 24

Modification 17

Mounting 25

Mounting height 57

Mounting instructions 28

Mounting technic 28

N

Non-electrical data 58

O

Operating sequence of installation 33

Operation 35

Operation height 37

Overview 23

P

Packing 21

Personnel 18

qualified 18

Prepare mounting 26

Protective measures 7

Q

Qualified personnel 18, 26, 36

R

Recommissioning 43

Recycling 47

Relative air humidity 37

Repair 39

Residual energy 19

Responsibility and liability 20

S

Safety instructions 20

Safety notes 7

Screwing (UL) 33

Screws 30

Set out of operation 42

Skilled person 18

Spare parts 51

Storage 41

Storage conditions 42



Index

T	
Temperature	37
Terms	
definition	6
Transportation	21
climatic category	21
shock	21
temperature range	21
Type key	24
U	
UL 508 C	32
Unpacking	21
W	
Washers	30
WEEE, 2002/96/EG	45

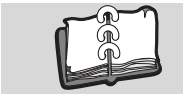

Revision survey

Version	Version	Changings
5.05010.01	23.05.2005	First edition

be in motion

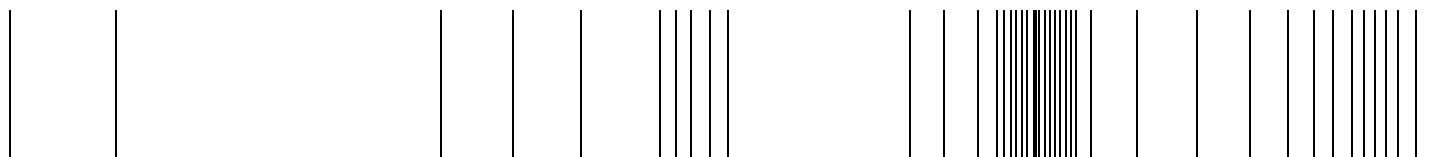

Baumüller Nürnberg GmbH Ostendstraße 80-90 90482 Nürnberg T: +49(0)911-5432-0 F: +49(0)911-5432-130 www.baumueller.de

All information given in this manual is customer information, subject to change without notice. We reserve the right to further develop and actualize our products continuously using our permanent revision service. Please notice, that specifications/data/information are current values according to the printing date. These statements are not legally binding according to the measurement, computation and calculations. Before you make any information given in this manual to the basis of your own calculations and/or applications, please make sure that you have the latest edition of the information in hand. No liability can be accepted concerning the correctness of the information.