

be in motion be in motion

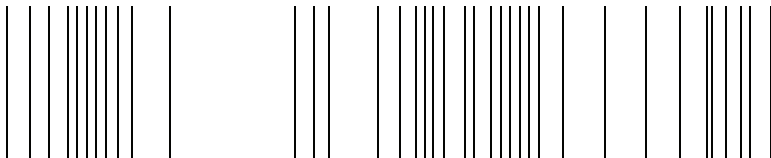

**Technology
Module**

Positioning V-Controller

Manual

E	5.96187.03a
----------	-------------



BAUMÜLLER

Title	Manual
Product	Technology Module Positioning V-Controller
Version	5.96187.03a
Copyright	<p>These operating instructions may be copied by the owner in any quantity but only for internal use. For other purposes these operating instructions and extracts thereof may not be copied or reproduced.</p> <p>Use and disclosure of information contained in these operating instructions are not permitted.</p> <p>Designations and company marks contained in these operating instructions may be brand names, the use of which by third parties for their own purposes may violate the rights of the holders.</p>
Obligatory	<p>These operating instructions are part of the equipment/machine. These operating instructions must be available to the operator at all times and must be in a legible condition. If the equipment/machine is sold or moved to a different location these operating instructions must be passed on by the owner together with the equipment/machine.</p> <p>After any sale of the equipment/machine this original and all copies must be handed over to the buyer. After disposal or any other end of use this original and all copies must be destroyed.</p> <p>When the present operating instructions are handed over, corresponding sets of operating instructions of a previous version are automatically invalidated. Please notice that specifications/data/information are current values according to the printing date. These statements are not legally binding according to the measurement, computation and calculations.</p> <p>Baumüller Nürnberg GmbH reserves the right, in developing its products further, to change the technical specifications and the handling of the products concerned without prior notice.</p> <p>No liability can be accepted concerning the correctness of the operating instructions unless otherwise specified in the General Conditions of Sale and Delivery.</p>
Manufacturer	<p>Baumüller Nürnberg GmbH Ostendstr. 80 - 90 D-90482 Nürnberg Germany Tel. +49 9 11 54 32 - 0 Fax: +49 9 11 54 32 - 1 30 www.baumueller.de</p>

TABLE OF CONTENTS

1 Installation 3

 1.1 General 3

 1.2 Encoder Systems 3

2 Commissioning 5

 2.1 Setting the Parameters 5

 2.2 Control Word, State Word 6

 2.2.1 Target Position Specification Mode 6

 2.2.2 Reference Run Mode 7

 2.2.3 Manual Mode (Inching Operation) 7

 2.3 Positioning 8

 2.4 Reference Run 9

3 Parameter 15

 3.1 Global Parameters 15

 3.2 Positioning Data Set Parameters 26

 3.3 Parameter List 29

4 Testing Operation Mode 31

 4.1 Testing Operation Mode Reference Run 31

 4.2 Testing Operating Mode Target Position Specification 35

 4.3 Testing the Manual Mode 38

5 Application Example Spindle Positioning 41

6 Appendix 47

 6.1 Index 47

ABBREVIATIONS

AI	Function module analog inputs
DI	Function module analog inputs
H	Level HIGH
hex	Input as a hexadecimal number
I	Counting unit of position
P	Function module position controller
L	Level LOW
M	Function module drive manager
N	Function module speed controller
POS	Function module positioning
RFG	Function module ramp function generator
RH	Rapid halt
SVG	Function module set value generator
SW	Software
t	Time
UU	User unit
v1	Speed of positioning data set 1
v2	Speed of positioning data set 2

1 INSTALLATION

1.1 General

The distance positioning is set out as single axis positioning. Distance positioning mode is possible in the same way as round table positioning, which is driven with direct positioning data set specification via a superordinated controller.

A selection can be made from 2 different positioning data sets.

The following diagram shows the structure of the positioning.

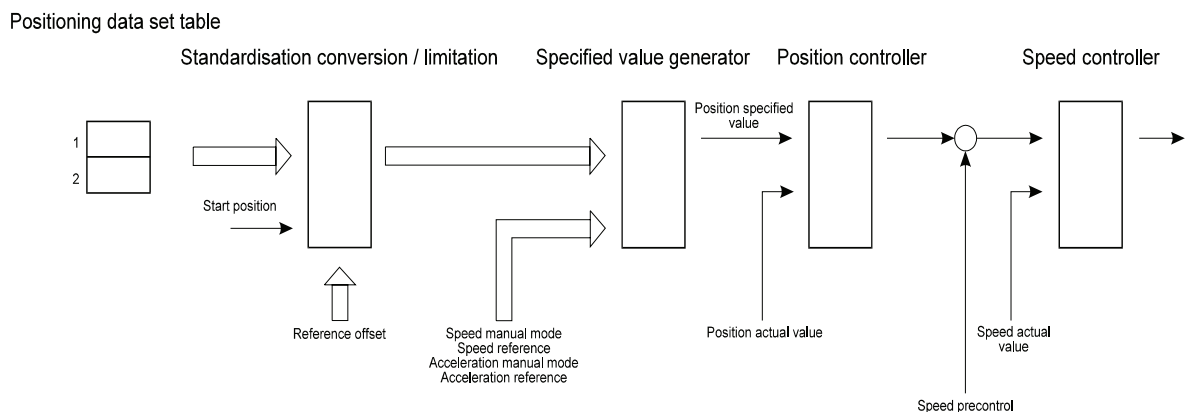

1.2 Encoder Systems

For recording the drive position, either the resolver built into the drive or an incremental encoder can be used. The various encoder systems are selected via the parameter POS Position actual value recording.

As both encoder systems supply relative position information (that of the resolver only absolutely refers to one revolution), a reference is necessary to refer the position of the drive absolutely to the process distance. Currently, a reference run with the resolver is the only one implemented.

Corresponding reference run traverses are possible for the various encoder systems. These are set via the parameter POS reference run mode.

2 COMMISSIONING

To install positioning the external options as well as the optimisation of the unit must be effected via the operation software. This settings can be stored in the controller.

2.1 Setting the Parameters

To install positioning the external options as well as the optimization of the unit must be effected via the operation software. This settings can be stored in the controller.

1. Basic setting:

- see Technical Description and Operation manual V-controller chapter „Initial Commissioning“

2. Setting the parameter of **position controller**:

- *P mode* : bit no. 2 = 0 for position measured on motor P201
bit no. 2 = 1 for position measured on load P202
- *P Kv factor* e.g. 40 P202

3. Setting the parameters of **drive manager**:

- *M control word* = 0 = 0000_{hex} (command inhibit voltage) P120
- *M desired operation mode* e.g. 1 = target position specification
5 = manual mode
6 = reference run mode P122
- *M control word* = 6 = 0006_{hex} (command inhibit operation) P120
- *M control word* = 15 = 000F_{hex} (command enable operation) P120



NOTE

Before the external pulse enabling can be switched on the positioning mode must be activated. The commissioning of the positioning mode is described in the following chapters.

2.2 Control Word, State Word

The control word and the state word correspond with the parameter P120 and P121. To activate the operation modes target position mode, reference run and manual mode, the explained sequence in chapter 3.1 has to be executed. Moreover the external pulse enabling must be given. Each module synchronises itself to the set position value (P208) of the position controller on start-up.

The meaning of the individual bits in the state and control words of the drive manager are, to some extent, mode-dependant. In the following text for the various modes will thus be listed.

Only bits relevant to the positioning are listed, i.e. only these have an effect on positioning modules or are controlled by them. A more detailed description of the control and status words can be found in the description of the drive manager.

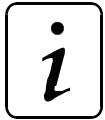

NOTE

The internal control sets back the positioning parameters to the initialising values, if the positioning is switched off (e.g. through a rapid halt). After switching on once more in the operation modes manual mode and reference run is started with the setting of position actual values to parameter P208 as soon as a start bit is set. If the start bit is already 1 the mode is started immediately. In the operation mode target position specification a position set has to be calculated before starting.

Start bits: Bit no. 11 in operation mode target position specification
 Bit no. 4 in operation mode reference run
 Bit no. 11 and 12 in manual mode

2.2.1 Target Position Specification Mode

M desired operation mode (P122) = 1.

Bit no.	M control word (P120)	M state word (P121)
0		
1		
2	Rapid halt	
3		
4	New set value *	
5		
6		
7		
8		
9		
10		Target position reached
11	Start positioning	
12		Set value acknowledgement *
13		
14		
15		

* This bits have no function and they are only reserved because of compatibility.

2.2.2 Reference Run Mode

M desired operation mode (P122) = 6.

Bit no.	M control word (P120)	M state word (P121)
0		
1		
2	Rapid halt	
3		
4	Start reference run	
5		
6		
7		
8		
9		
10		Speed set value reached
11		
12		Reference reached
13		Reference error
14		
15		

2.2.3 Manual Mode (Inching Operation)

M desired operation mode (P122) = 5.

Bit no.	M control word (P120)	M state word (P121)
0		
1		
2	Rapid halt	
3		
4		
5		
6		
7		
8		
9		
10		
11	Inch forwards	
12	Inch backwards	
13		
14		
15		

2.3 Positioning

At the start of positioning, the system either selects a position block (P401) or transfers one. The *Start Positioning* command (bit no. 11 in the control word) starts positioning.

The start bit must always be set at the start of a positioning manoeuvre. In this case, positioning is finished regardless of the start bit.

Depending on the *Target position* parameter (P416 or P423), the following differences result for this start bit:

- In the case of an absolute target destination (target position = 0), the start bit can be continuously set and the system carries out positioning to the absolute target position that is current at any one time. This means that with the start bit set, only new (absolute) target positions need to be written.
- In the case of normal relative target destination (target position = 1, -1) on the other hand, the positive edge of the start bit is crucial. The system generates the new target position relative to the old one when the positive edge of the start bit appears.
- In the case of on-the-fly relative target destination (target position = 2, -2) the positive edge of the start bit is also crucial. The system generates the new target position relative to the current actual position when the positive edge of the start bit appears.

Destination positions can be changed at any time. Even when the drive is currently moving, it immediately starts carrying out positioning to the new target position. Changes to the positioning block, the positioning speed, the positioning acceleration and the positioning delay are also effective immediately.

Once the drive control has accepted the start command, the drive starts positioning and *Position reached* (Bit no. 10 in the state word) changes to 0.

If the positioning function detects a fast brake request, this leads to the drive braking to a standstill in accordance with parameter M RAPID HALT code (P131) positioning being deactivated. If you enable operation again and request a new start, with **absolute** positioning the drive carries out positioning to the original destination position.

2.4 Reference Run

Exact knowledge of the absolute position of the drive is generally required for operation with positioning drives. If an incremental encoder is applied for position actual value recording, or if more than one revolution is required for the entire traversing range for position actual value recording with a resolver, a reference run is required. Absolute value encoders are initialized by a reference run, too. The reference position and the starting direction, and thus also the exact traverse of the reference run, are set via the parameter reference run mode (P414).

The reference runs according DRIVECOM are divided into following stages.

- Stage 1
In stage 1 the reference speed is used, as defined in parameter P412.
- Stage 2
After reaching the reference initiator (end switch or zero point transfer switch), the drive is braked to zero speed via the Rapid halt deceleration (P442) and is driven in the opposite direction at an eighth of the reference terminal speed (P443). The acceleration value is set in the parameter POS Reference acceleration (P413).
- Stage 3
The next switching transition of the switch causes braking to reference terminal speed (P443). As soon as the reference module specifies this speed, the resolver angle is recorded.

If the encoder's zero angle * (reference point) respectively is recorded no further position set values are set and the drive remains stationary. The current resolver angle and the position value of the reference point (P432) are then copied to the position actual/set values P209, P208), as soon as the POS actual value (P437) stays the set time (P430) within the position tolerance range (P429).
- Stage 4 (resolver / absolute value encoder)
In stage 4 positioning takes place according to the reference point value. In repeated running of the reference point a deviation up to 0.1° should be allowed for.
- Phase 4 with incremental encoders
In this case the system carries out approaching to the reference point that is offset by the *Encoder offset* (P043) at the *Ref. terminal speed* (P443).

To deliver identical reference points, following conditions must be satisfied:

- Referencing speed-acceleration, -deceleration as well as encoder offset may not be altered once set.
- The referencing speed must be reached in stage 1.

* At encoder zero angle the parameter Mot phi mechanical (P030) is 180°.

Producer defined reference runs

Reference runs -4 and -5 :

These modes only use end switches for reference.

-4 = go to the negative end switch

-5 = go to the positive end switch

The reference runs -4 and -5 are divided into following stages.

- Stage 1
In stage 1 the reference speed is used, as defined in parameter P412.
- Stage 2
After reaching the end switch with reference deceleration (P442), the drive is braked to zero speed via the Rapid halt deceleration (P442) and is accelerated in the opposite direction at an eighth of the reference terminal speed (P443). The acceleration value is set in the parameter POS Reference acceleration (P413).
- Stage 3
The next switching transition of the end switch causes braking and a movement in the opposite direction. The drive moves now with reference terminal speed P443 towards an end switch.
- Stage 4
As soon as the end switch is reached the drive is stopped. The actual position represents the reference point. The current position value of the reference point (P432) are then copied to the position actual/set values (P209, 208), as soon as the POS actual value (P437) stays the set time in the position tolerance range (P429).

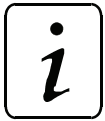

NOTE

The reference runs -4 and -5 are not as accurate as because of the switching tolerance of the end switches. However a setting of the encoder offset is not necessary (P435)

Reference runs -1, -2 and -6 (resolver, absolute value encoder) or -101, -102 (incremental encoder):

The nearest resolver zero angle is referenced during these modes. At -1 or -101 the drive moves to the right and at -2 or -102 the drive moves to the left to the resolver zero angle respectively the zero impulse.

At -6 the drive takes the shortest way to the resolver zero angle. The speed during this is programmed to reference terminal speed (P443). No reference initiator (end switch or zero point transfer switch) is necessary.

Reference run -3 :

In this mode the position value of the reference point is copied immediately to the position actual/ set value (P209 and 208) without movement of the drive!



NOTE

- If the bit no. 12 in M status word (P121) is not set after reference run, the value of the parameter POS position range (P429) must be enlarged.
- If the position of the tool slide does not require a return at reference initiator, phase 1 does not apply and it is accelerated to an eighth of the reference speed (phase 2).
- The zero angle of the resolver for internal calculation can be moved via the parameter encoder offset (P435) so that it lies outside the tolerances of the switches. The encoder zero angle at encoder offset of 0 increments corresponds to an actual resolver angle of 180°.
- Should the limit switch be exceeded, it is necessary to maintain the condition until the switch is re-activated after a reversal of direction.

Move to the negative end switch

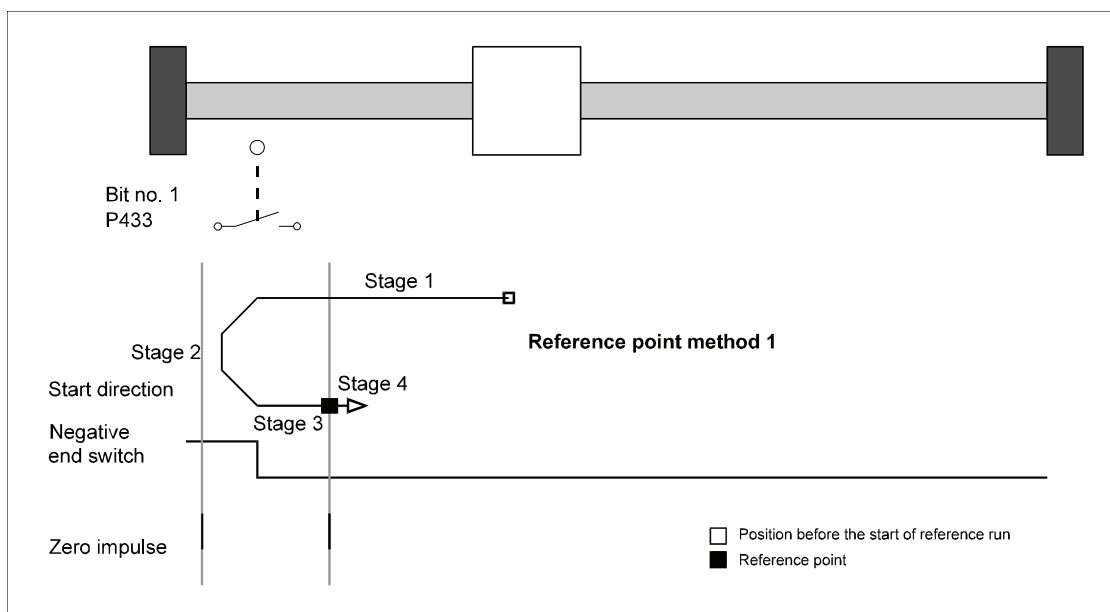

Move to the positive end switch

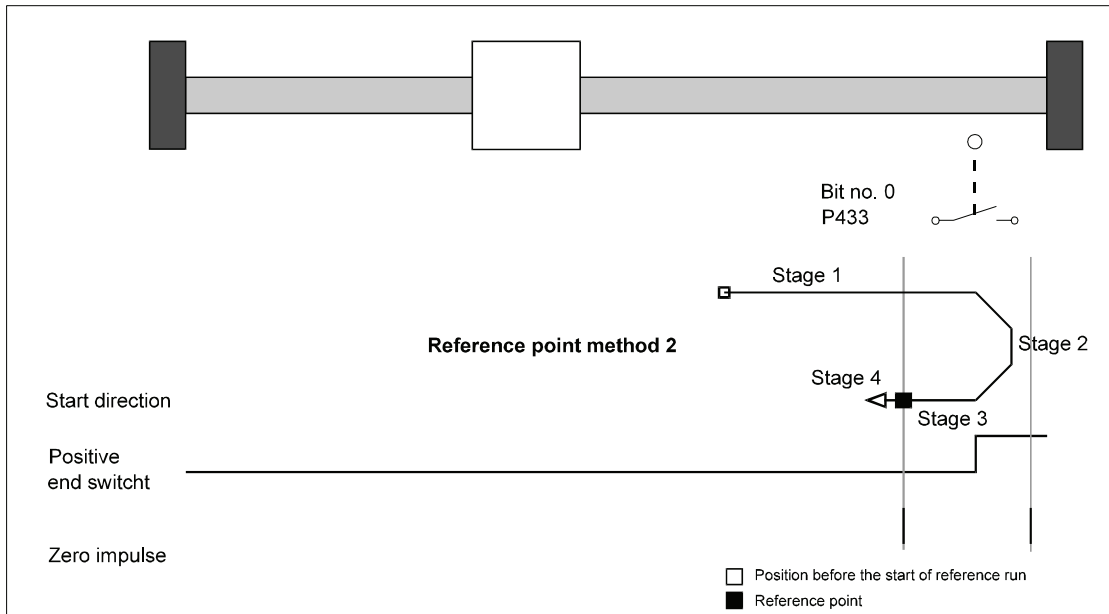

Move to the positive zero point transfer switch

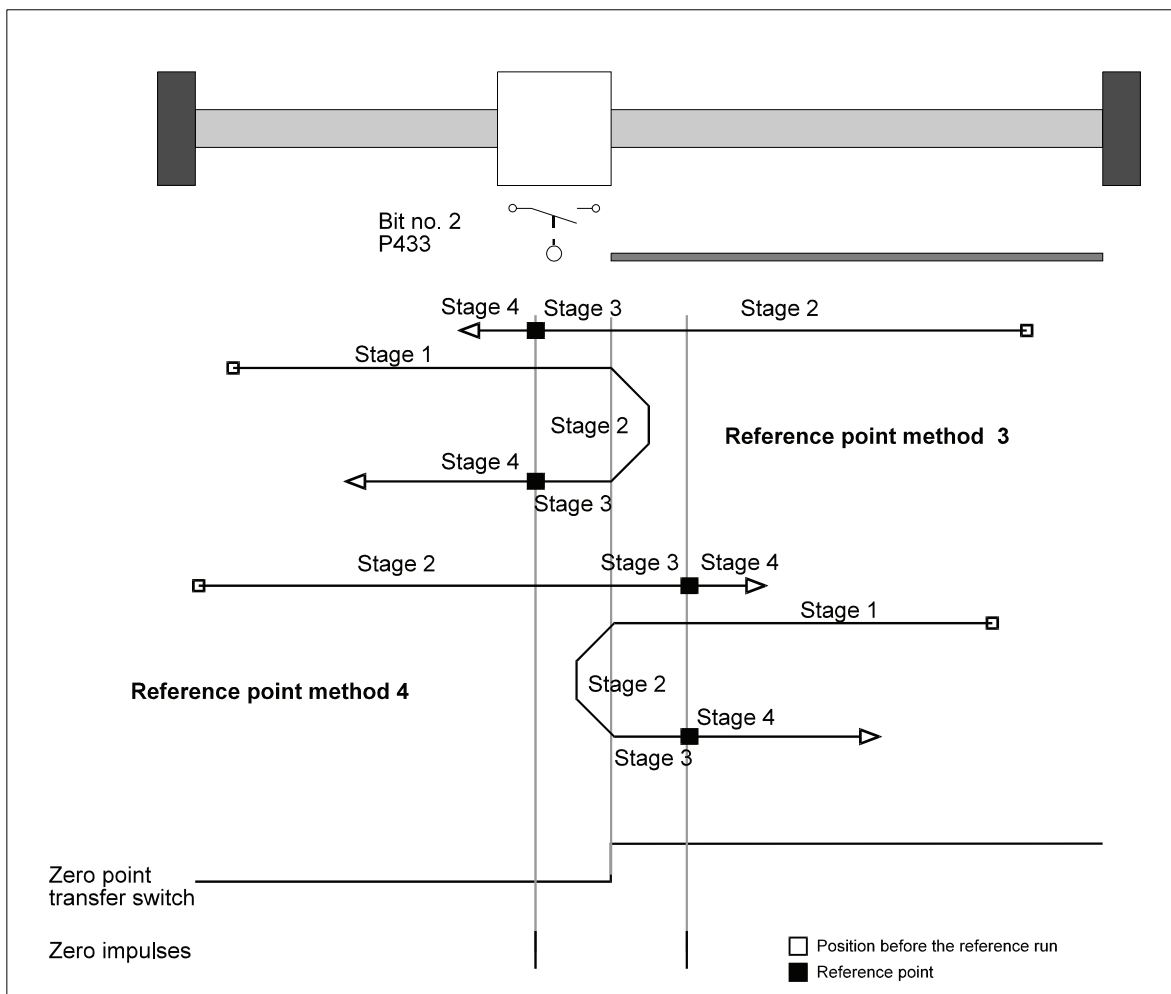

Move to the negative zero point transfer switch

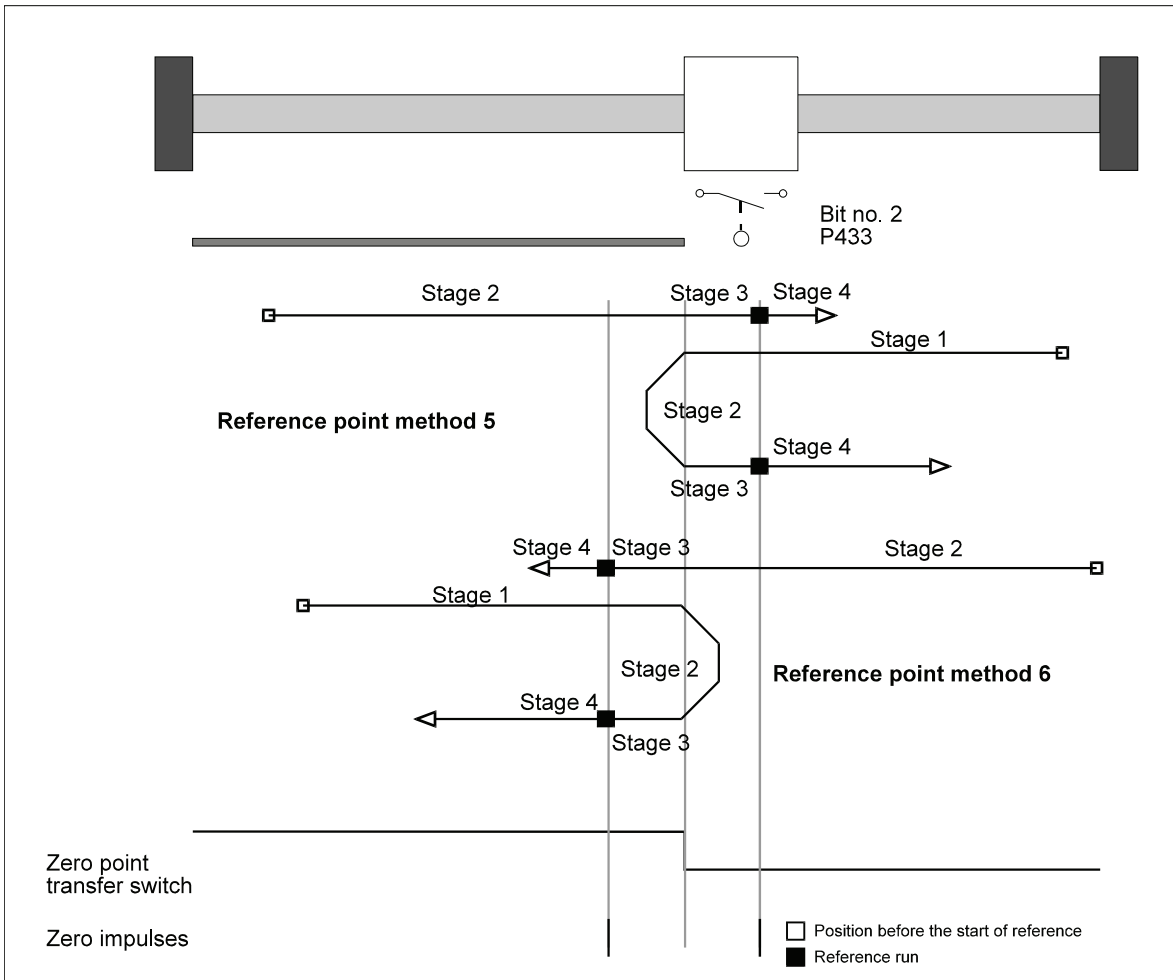

NOTE

Should the limit switch be exceeded, it is necessary to maintain the condition until the switch is re-activated after a reversal of direction.

3 PARAMETER

With parameters relevant for positioning, differentiation is drawn between global parameters i.e. those applicable to both traversing sets, and position-set related parameters.

3.1 Global Parameters

Parameter overview

Parameter	Name	Range min. ... max.	Unit	Display only
P400	POS module state	0000 ... FFFF		×
P401	POS current set number	1 ... 2		
P402	POS norm position Z	1 ... 65535	I	
P403	POS norm position N	1 ... 32768	UU	
P406	POS mode	0000 ... FFFF		
P407	POS rapid halt terminal velocity	0	I / ms	
P408	POS rapid halt deceleration	0.25 ... 650.00	I / ms ²	
P409	POS inching speed	1 ... 13200	I / ms	
P410	POS inching acceleration	0.25 ... 650.00	I / ms ²	
P411	POS inching deceleration	0.25 ... 650.00	I / ms ²	
P412	POS reference speed	50 ... 13200	I / ms	
P413	POS reference acceleration	0.25 ... 650.00	I / ms ²	
P414	POS reference run mode	-2199 ... 2199		
P429	POS position tolerance range	0 ... FFFF FFFF	UU	
P430	POS position tolerance range time	1 ... FFFF	ms	
P431	POS loose offset	0 ... FFFF FFFF	UU	
P432	POS reference point	0 ... FFFF FFFF	UU	
P433	POS state switch	0 ... FFFF		×
P434	POS mode switch	0 ... FFFF		
P435	POS encoder offset	0 ... FFFF	I	
P436	POS position set value	0 ... FFFF FFFF	UU	×
P437	POS position actual value	0 ... FFFF FFFF	UU	×
P438	POS set speed	-13200 ... +13200	I / ms	×
P439	POS SW end switch 1	0 ... FFFF FFFF	UU	
P440	POS SW end switch 2	0 ... FFFF FFFF	UU	
P441	POS rounding	0 ... 8191	ms	
P442	POS reference deceleration	0.25 ... 650.00	I / ms ²	
P443	POS reference terminal speed	1 ... 50	I / ms ²	
P444	POS clip tolerance	1 ... FFFFFFFF	UU	

I = Increments
UU = User Unit

Standardization of speed and acceleration:

1 revolution ↔ 65536 Increments

$$1000 \frac{\text{I}}{\text{ms}} = 1000 \cdot \frac{60 \cdot 1000}{65536} \text{rpm} = 915 \text{rpm}$$

Parameter description

P400 POS module state

This parameter shows the status of the positioning module. The bits are not used from all operation modes.

Bit no.	Meaning	Target position specification mode	Manual mode	Reference run
0	0: STOP 1: RUN	×	×	×
4	1: SW end switch 1 active	×	×	
5	1: SW end switch 2 active	×	×	
6	1: Initialization error	×	×	×
7	1: Function completed	×		
8	reserved	×		
9	reserved	×		
10	1: Norm position Z < norm position N	×	×	×
11	1: Traversing range will be exceeded	×	×	
12	1: Set value reached	×		×
13	1: Clip tolerance reached	×		

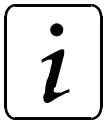

NOTE

- Bit no. 11 is set when the traversing range will be exceeded
- If a rapid halt is ended, all bits are reset and positioning is switched of
- Bit no. 12 „Set value reached“ means in the operational mode „Position target reached“ and in the reference run „Reference speed reached“.

P401 POS current set number

The current positioning set is selected via this parameter.

Value	Meaning
1	Positioning data set 1 active
2	Positioning data set 2 active

P402 POS norm position Z**P403** POS norm position N

These parameters are used for the conversion of the application-specific position parameters into the internal number standardization (1 motor revolution ↔ 65536 increments).

Application-specific position parameters are all global parameters and all positioning set parameters which contain the abbreviation UU (user unit) in their unit.

Conversion to standardization, using a position input parameter by way of example:

$$\text{Input parameter[I]} = \text{Input parameter[BE]} \frac{\text{POS norm position Z [I]}}{\text{POS norm position N [UU]}}$$

**NOTE**

- **Condition 1: POS norm position Z ≥ POS norm position N**
If this condition is not fulfilled, the last standardization parameter that was written stays set to its old value and the system sets bit no.10 in the module state

The system does not reset the bit and accept the new standardization until one of the two parameters has been changed such that the condition is fulfilled.
- **Condition 2:**
The permissible limits of the application-specific position input parameters reduce by the factor $\frac{\text{POS norm position N}}{\text{POS norm position Z}}$. The system does not monitor exceeding of these limits; the operator is responsible!
- **Condition 3: POS norm position Z + POS norm position N ≤ 65536**
This condition is monitored automatically.
- In the case of standardization conversion of the application-specific input parameters, all the values are rounded down. Positioning is carried out in accordance with the possible calculation precision. However, no position values are lost if relative positioning is carried out again.
Extending the standardization factor does not lead to a higher resolution, e.g.

$$\frac{20000}{1000} = \frac{20}{1}$$

P 406 POS mode

This parameter switches functions on respectively off..

Bit no.	Meaning
0	1: Software end switches active
1 - 15	Reserved



NOTE

The function of the software end switches has to be fixed before first positioning.

P 407 POS rapid halt terminal velocity

Not implemented.

P 408 POS rapid halt deceleration

The deceleration in the case of a rapid halt is entered via this parameter. If the rapid halt is to take place corresponding to this slope, the parameter M rapid halt code (P131) must be set to 1 or 2. Positioning is only switched off after completion of the rapid halt. Otherwise, positioning is immediately switched off and the rapid halt is carried out according to the selection code.

P 409 POS inching speed

The inching speed corresponds to the drive's traversing speed in manual mode.

P 410 POS inching acceleration

The inching acceleration describes the maximum acceleration of the drive in manual mode.

P 411 POS inching deceleration

The inching deceleration corresponds to the maximum deceleration of the drive in manual mode.

P 412 POS reference speed

The reference speed corresponds to the total maximum traversing speed of the drive in reference run mode.

P 413 POS reference acceleration

The reference acceleration describes the maximum acceleration of the drive in mode reference run. The reference deceleration (P442) applies for braking the drive in mode reference run.

P414 POS reference run mode

This parameter describes the reference run procedure. The starting direction of the reference run and the evaluation of the reference initiator are set by various modes.

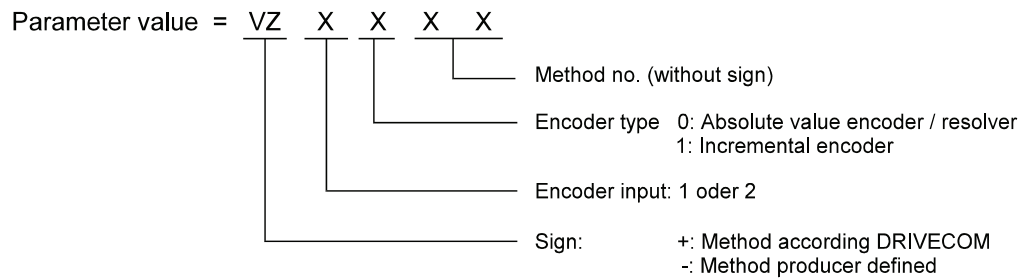

Method = Sign - Method no.

**NOTE**

Specifying the encoder type and the encoder input is not relevant to methods -3, -4 and -5. For this reason, the parameter value consists only of the method number

Encoder type	Encoder connected with input	Method no.	Parameter value (P414)
Absolute value encoder	1	-6	- 1 0 06
Absolute value encoder	1	-2	- 1 0 02
Absolute value encoder	1	-1	- 1 0 01
Absolute value encoder	1	1	1 0 01
Absolute value encoder	1	2	1 0 02
Absolute value encoder	1	3	1 0 03
Absolute value encoder	1	4	1 0 04
Absolute value encoder	1	5	1 0 05
Absolute value encoder	1	6	1 0 06
Absolute value encoder	2	-6	- 2 0 06
Absolute value encoder	2	-2	- 2 0 02
Absolute value encoder	2	-1	- 2 0 01
Absolute value encoder	2	1	2 0 01
Absolute value encoder	2	2	2 0 02
Absolute value encoder	2	3	2 0 03
Absolute value encoder	2	4	2 0 04
Absolute value encoder	2	5	2 0 05
Absolute value encoder	2	6	2 0 06
Incremental encoder	1	-2	- 1 1 02
Incremental encoder	1	-1	- 1 1 01
Incremental encoder	1	1	1 1 01
Incremental encoder	1	2	1 1 02
Incremental encoder	1	3	1 1 03
Incremental encoder	1	4	1 1 04
Incremental encoder	1	5	1 1 05
Incremental encoder	1	6	1 1 06
Incremental encoder	2	-2	- 2 1 02
Incremental encoder	2	-1	- 2 1 01
Incremental encoder	2	1	2 1 01
Incremental encoder	2	2	2 1 02
Incremental encoder	2	3	2 1 03
Incremental encoder	2	4	2 1 04
Incremental encoder	2	5	2 1 05
Incremental encoder	2	6	2 1 06
not relevant	not relevant	-5	-5
not relevant	not relevant	-4	-4
not relevant	not relevant	-3	-3

Method	Meaning
-6	Move to the next encoder zero angle
-5	Move to the positive end switch
-4	Move to the negative end switch
-3	Set reference point
-2	Move to the encoder zero angle or zero impulse with left turn
-1	Move to the encoder zero angle or zero impulse with right turn
1	Move to the negative end switch with setting encoder zero angle or zero impulse
2	Move to the positive end switch with setting encoder zero angle or zero impulse
3	Move to the positive zero point transfer switch with setting encoder zero angle or zero impulse
4	Move to the positive zero point transfer switch with setting encoder zero angle or zero impulse
5	Move to the negative zero point transfer switch with setting encoder zero angle or zero impulse
6	Move to the negative zero point transfer switch with setting encoder zero angle or zero impulse

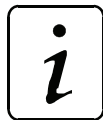

NOTE

If you enter incremental encoder as the encoder type, the system assumes that a zero pulse is provided. Only in this case are you allowed to set the reference travel modes intended for incremental encoders.

P429 POS position tolerance range

If the drive reaches a tolerance range around the new target position, the bit „Target position reached“ is set in the status word. The target position is in the centre of this range. Its size is set by the parameter „Position tolerance range“.

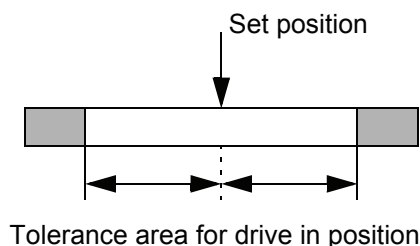

Tolerance area for drive in position

P430 POS position tolerance range time

In order to prevent the bit „Drive in position“ being set in the event of the positioning range being temporarily entered, a time can be set, via this parameter, during which the drive must be in the positioning range before correct positioning is announced.

P431 POS loose offset

Not implemented.

P 4 3 2 POS reference point

The position value POS reference point is the absolute position of the drive at the reference point. This value must be set before reference run is started. Has the drive reached the reference point after the reference run this position value is copied to position set value and position actual value. The value of the reference point must be within the permitted positioning range, i.e. between the software end switches (P439 and P440).

P 4 3 3 POS state switch

The status of the end switch, the reference initiator and the rapid halt switch are represented by this parameter.

If the bit which corresponds to the switch is bit 1, the switch is operated.

Bit no.	Meaning
0	state end switch positive
1	state end switch negative
2	state zero point transfer switch
3 - 15	reserved

Examples:

Programming digital input 1 for positive end switch (method 2)

DE input 1 Pxxx = 433 P370
DE bit selection 1 = 1 = 0001_{hex} P371
DE LOW pattern 1 = 0 = 0000_{hex} P372
DE HIGH pattern 1 = 1 = 0001_{hex} P373

Programming digital input 1 for negative end switch (method 1)

DE input 1 Pxxx= 433 P370
DE bit selection 1 = 2 = 0002_{hex} P371
DE LOW pattern 1 = 0 = 0000_{hex} P372
DE HIGH pattern 1 = 2 = 0002_{hex} P373

Programming digital input 1 for zero point transfer switch (method 3 to 6)

DE input 1 Pxxx = 433 P370
DE bit selection 1 = 4 = 0004_{hex} P371
DE LOW pattern 1 = 0 = 0000_{hex} P372
DE HIGH pattern 1 = 4 = 0004_{hex} P373



NOTE

The system evaluates bit no. 0 and bit no. 1 as limit switch states in manual mode too!

P434 POS mode switch

Each end switch and zero point transfer switch can all be set individually as a make or a break contact via this parameter..

Bit no.	Meaning
0	mode end switch positive
1	mode end switch negative
2	mode zero point transfer switch
3 - 15	reserved

Bit = 0: switch is a make contact
 Bit = 1: switch is a break contact

Connection of the digital inputs (prefer because of wire break):

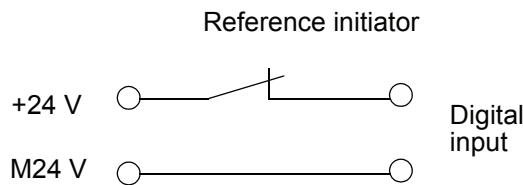

P435 POS encoder offset

The encoder offset is added to the current resolver angle during the reference run and thus permits movement of the zero angle signal. The zero angle signal can hence be set outside the switching tolerance of the end switch or reference initiator.

P436 POS position set value

The position set value created on positioning is displayed in BE (see P208 Position set value in increments).

P437 POS position actual value

The current position actual value is displayed in UU (see P209 Position set value in increments).

P438 POS set speed

The current set speed set on positioning is displayed in l/ms.

P 4 3 9 POS **SW end switch 1**

P 4 4 0 POS **SW end switch 2**

The 2 parameters limit the permitted range of processing in the operational mode target position and manual mode.

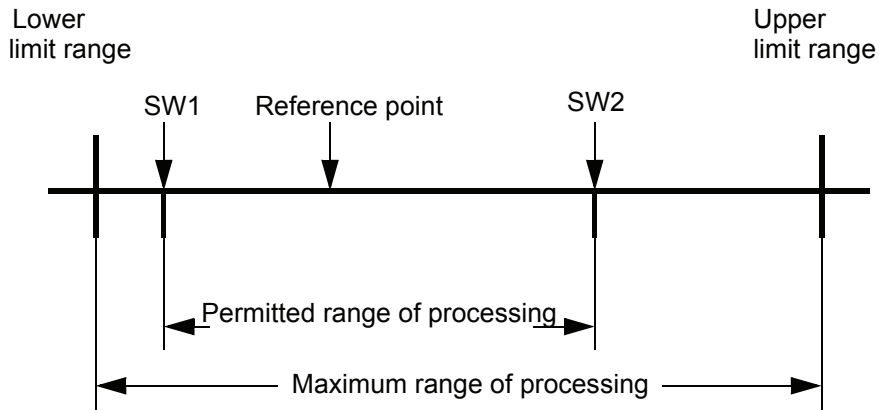

Lower limit range = 0000 0000_{hex};

Upper limit range = 0xFFFFFFFF · $\frac{\text{POS norm position N (P403)}}{\text{POS norm position Z (P402)}}$

The limit switch 1 contains the value for the permitted processing range start, the limit switch 2 contains the permitted processing range end.

Following requirements must be satisfied for the correct functioning of the software end switches:

- Bit no. 0 must be set in parameter POS mode (P406)
- A reference run must be carried out before switching over to the target position specification mode or manual mode. SW limit switches are not active in reference run!
- $0 < \text{SW end switch 1} < \text{reference point} < \text{SW end switch 2} < \text{upper limit range}$.
- The maximum range must not be exceeded (apart from the reference run).

Function of the software end switches:

- In the target position specification mode (P122 = 1)
By means of New set value = 1 a new position set is accepted. Thus, the target position is outside the permitted processing range, is checked by calculation the positioning data. Is this the case a process ramp is calculated to the SW end switch whose value should be exceeded. Additionally either the bit no. 4 for the limit switch 1 or the bit no. 5 for SW end switch 2 is set in the module state (P400).
The drive can stand outside the newly permitted process range if the value of a SW end switch is altered after the reference run. The activation of the display in POS module state as well as the validity of the new value are effected by the next transfer of data. Should the preset target position lie outside, it will, independent of the target reading, be positioned according to the SW end switch.

- In the manual mode (P122 = 5):
As soon as a SW end switch is reached, the drive will slow down according the set POS rapid halt deceleration (P408) and the corresponding bit at the POS module state will be activated. A Movement is only possible in the opposite direction of travel.
Should the value of a SW end switch altered after the reference run the drive position could lie outside the newly permitted process range. The display is activated in the POS module state as soon as an inching is carried out.

It is only after a complete optimization and commissioning of the positioning the drive will possess 2 SW end switches in the operation modes target position specification and manual mode, so that no mechanical end switches are required in this operating modes. However, to systematically reduce the enormous energy produced by an moving drive, limit switches are unalterably connected to the power module or influence the pulse enabling setting of the controller.

P 4 4 1 POS rounding

To round the edges of the ramps a PT1 term is implemented. This parameter sets the integration time.

The rounding is not active if the setting is 0 ms.

P 4 4 2 POS reference deceleration

The reference run deceleration indicates the maximum drive deceleration during the reference run.

P 4 4 3 POS reference terminal speed

The referencing terminal speed indicates the amount of the traverse speed at which the drive is to approach the encoder zero angle or the zero pulse. This parameter is only effective in reference run mode.

P 4 4 4 POS clip tolerance

If the actual value of the position reaches a window round the destination position, the system sets the clip tolerance reached bit (bit no. 13 in parameter P400, module state). This window is symmetrical to the destination position and its size is determined by the clip tolerance parameter.

3.2 Positioning Data Set Parameters

The parameter *actual data set number* (P401) selects between 2 data sets.

Parameter overview

Parameter	Name	Range min. ... max.	Unit	Display only
415	POS target position 1	0 ... FFFF FFFF	UU	
416	POS target input 1	-2 ... +2		
417	POS positioning speed 1	1 ... 13200	l / ms	
418	POS terminal velocity 1	0	l / ms	
419	POS positioning acceleration 1	0.25 ... 650.00	l / ms ²	
420	POS positioning deceleration 1	0.25 ... 650.00	l / ms ²	
421	POS dwell time 1	0 ... 65535	ms	
422	POS target position 2	0 ... FFFF FFFF	UU	
423	POS target input 2	-2 ... +2		
424	POS positioning speed 2	1 ... 13200	l / ms	
425	POS terminal velocity 2	0	l / ms	
426	POS positioning acceleration 2	0.25 ... 650.00	l / ms ²	
427	POS positioning deceleration 2	0.25 ... 650.00	l / ms ²	
428	POS dwell time 2	0 ... 65535	ms	

Parameter description

P415 POS target position 1

P422 POS target position 2

The target position is the position in UU at which the drive has reached terminal velocity.

P416 POS target input 1

P423 POS target input 2

The „target input“ describes whether the target position is entered absolutely or is to be started relatively to the last set position.

Value	Meaning
-2	Relative to the actual position towards lower position set values (on-the-fly)
-1	Relative to the destination position towards lower position set values (normal)
0	Absolute
1	Relative to the destination position towards higher position set values (normal)
2	Relative to the actual position towards higher position set values (on-the-fly)

P417 POS **positioning speed 1**

P424 POS **positioning speed 2**

The positioning speed refers to the maximum traversing speed of the drive in positioning mode.

P418 POS **terminal velocity 1**

P425 POS **terminal velocity 2**

Not implemented.

P419 POS **positioning acceleration 1**

P426 POS **positioning acceleration 2**

The maximum acceleration of the drive in positioning mode is set via this parameter.

P420 POS **positioning deceleration 1**

P427 POS **positioning deceleration 2**

As with maximum acceleration, the positioning deceleration shows the maximum deceleration of the drive in positioning mode.

P421 POS **dwell time 1**

P428 POS **dwell time 2**

Not implemented.

3.3 Parameter List

	Parameter	Page	Standard value	Internal standardization
	P400 POS module state	16		
	P401 POS current set number	16		
	P402 POS norm position Z	17		
	P403 POS norm position N	17		
	P406 POS mode	18		
	P407 POS rapid halt terminal velocity	18		
	P408 POS rapid halt deceleration	18		
	P409 POS inching speed	18		
	P410 POS inching acceleration	18		
	P411 POS inching deceleration	18		
	P412 POS reference speed	18		
	P413 POS reference acceleration	18		
	P414 POS reference run mode	19		
	P415 POS target position 1	26		
	P416 POS target input 1	26		
	P417 POS positioning speed 1	27		
	P418 POS terminal velocity 1	27		
	P419 POS positioning acceleration 1	27		
	P420 POS positioning deceleration 1	27		
	P421 POS dwell time 1	27		
	P422 POS target position 2	26		
	P423 POS target input 2	26		
	P424 POS positioning speed 2	27		
	P425 POS terminal velocity 2	27		
	P426 POS positioning acceleration 2	27		
	P427 POS positioning deceleration 2	27		
	P428 POS dwell time 2	27		
	P429 POS position tolerance range	21		
	P430 POS position tolerance range time	21		
	P431 POS loose offset	21		
	P432 POS reference point	22		
	P433 POS state switch	22		
	P434 POS mode switch	23		
	P435 POS encoder offset	23		
	P436 POS position set value	23		
	P437 POS position actual value	23		

Parameter

	Parameter	Page	Standard value	Internal standardization
	P438 POS set speed	23		
	P439 POS SW end switch 1	24		
	P440 POS SW end switch 2	24		
	P441 POS rounding	25		
	P442 POS reference deceleration	25		
	P443 POS reference terminal speed	25		
	P444 POS clip tolerance	25		

4 TESTING OPERATION MODE

The procedure for testing the operation modes reference run, target position specification and manual mode are described in the following chapters.

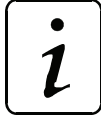

NOTE

The parameters must be set correctly before test starts!

4.1 Testing Operation Mode Reference Run

- **Setting the relevant parameters**

Setting of mode form external user units (UU) to internal increments (I)

POS norm position Z e.g. 1 P402

POS norm position N e.g. 1 P403

If both parameters are set to one, then 1 increment (I) = 1 user unit (UU).

The definition of the motor direction is set in the parameter *RFG polarity* (P017).

Setting of the speed profile during reference run

POS reference speed e.g. 500 I/ms P412

POS reference acceleration e.g. 5.00 I/ms² P413

POS reference deceleration e.g. 10.00 I/ms² P442

The position value which the absolute position of the drive at the reference point indicates must be input into parameter POS reference point (P432), e.g. 655360 UU.

The position of the reference point and the start direction, i.e. the exact cycle of the reference run is set via parameter *POS reference run mode* (P414).

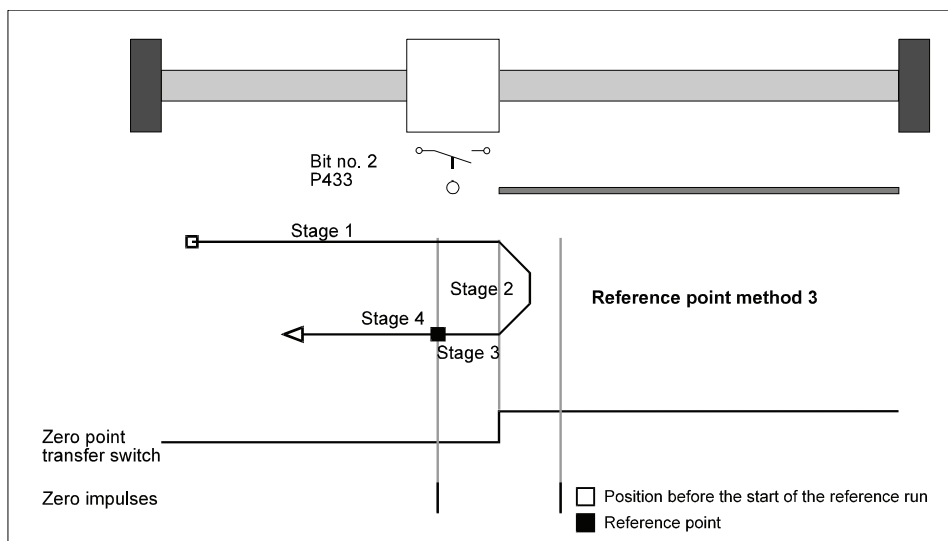

In this example method 3 (starting the positive zero point transfer switch) must UU used. This means that the zero point transfer switch left of the zero point must UU always un-activated and the zero point transfer switch right of the zero point must UU always activated. The reference point lies right of the zero!

POS reference run mode z.B. 3

P414

In the *POS mode switch* (P434) each reference initiator can UU set separately, whether it is a normally open or normally closed contact.

Because of the set *POS reference run mode* in the example the zero point transfer switch is only evaluated during the reference. The zero point transfer switch used is a normally closed contact.

POS mode switch : 0004_{hex} (Bit no. 2 = 1)

The bit no. 0 und 1 are not relevant for *POS reference run mode*.

- **Programming of the digital input for the reference run**

In the example the digital input 1 is programmed at bit no. 2 parameter POS switch state (P433).

DI input 1 Pxxx = 433 P370

DI bit selection 1 = 0004_{hex} P371

DI LOW pattern 1 = 0000_{hex} P372

DI HIGH pattern 1 = 0004_{hex} P373



NOTE

The input of 0000_{hex} is required! In parameter DI state (P382) bit 0 must be set to ensure that the digital input is switched active to the software.

For testing the reference initiator it can be activated manually. A verification is required that in parameter POS state switch (P433) is set the corresponding bit. In the example bit no. 2 must be set if the reference initiator is activated.

Care should be taken in setting that selected bit (via the digital input) of the POS state switch (P433) corresponds to the POS reference run mode (P414). (See description parameter P433)

- **Setting of operation mode**

Parameter M set operation mode (P122) must UU set on 6 for reference run mode.

- **Drive manager override**

For override of drive manager following input sequence is required.:

M control word = 6 = 0006_{hex} (command stand still) P120

M control word = 15 = 000F_{hex} (command operation override) P120

- **Setting external impulse release**

Please use operation manual in the event of questions relating to plug pin assignment.

- **Starting reference run**

Set bit no. 4 in parameter *M control word* (P120)

→ Reference run is being executed;

→ Reference run is terminated if *M status word* (P121) bit no. 12 is set.

Behaviour of drive in example:

- The drive rests right of zero point:

After starting signal the drive moves at *POS reference speed* (P412) in direction of zero point, turns around at zero point and stands still at reference point. (Stages 1 to 4; see chapter 3.4).

- The drive rests left of zero point:

After starting signal the drive moves at one eighth of the set speed in P412 toward the zero point, overruns zero point and stands still at reference point (stages 2 to 4, see chapter 3.4).

- **Check list for avoiding faults:**

- Drive doesn't start

→ Is the drive released and the external impulse release set?

→ Is M actual operating mode = 6 (P123)?

→ Is positioning activated, bit no. 0 = 1 at *POS module state* (P400) ?

→ Is start bit set in *M control word* (bit no. 4, P120)?

→ Is bit no. 12 set in *M status word* (P121)? If yes then the drive rests probably near the reference initiator. Because of the short displacement the movement is not recognised.

- Drive doesn't respond to reference initiator signal

→ Is M actual operating mode = 6 (P123)?

→ Is positioning activated, bit no. 0 = 1 at *POS module state* (P400) ?

→ Check programming of digital input (see 5.1.2)

- Bit no. 12 (reference reached) in M status word (P121) is not set after reference run is carried out.

→ Enlarge POS position tolerance range (P429) until bit is set.

→ Decrease POS position tolerance range time (P430) until bit is set.

- Drive is moving at lower speed than set in *POS reference speed* (P412)
 - Is M actual operating mode = 6 (P123)?
 - Is positioning activated, bit no.0 =1 at *POS module state* (P400) ?
 - State of reference initiator is activated hence the drive is only moving one eighth of the reference speed.
 - Check programming of digital input, in the event the drive movement being incorrect (see 5.1.2)
 - Check *POS mode switch* (P434)!
- After start drive is moving in wrong direction
 - Is M actual operating mode = 6 (P123)?
 - Is positioning activated, bit no. 0 =1 at *POS module state* (P400) ?
 - State of reference initiator is activated hence the drive is only moving one eighth of the reference speed.
 - Check programming of digital input, in the event the drive movement being incorrect (see 5.1.2)
 - Check *POS mode switch* (P434)!
 - Check *POS reference run mode* (P414)!
- After starting multiple reference runs there are two reference points.
 - change encoder zero angle with *POS encoder offset* (P435), e.g 32768 increments.
- The input at parameter *POS norm position Z* (P402) or *POS norm position N* (P403) is not accepted.
 - Following condition must be realised: *POS norm position Z* Š *POS norm position N*!
- The input at parameter *POS reference point* (P432), *POS SW end switch 1* (P439) or *POS SW end switch 2* (P440) is not accepted.
 - Following condition must be realised:
POS SW end switch 1 < *POS reference point* < *POS SW end switch 2*

4.2 Testing Operating Mode Target Position Specification

Before this operation mode a reference run (see chapter 5.1) must have executed.

For the following example the parameter values in chapter 5.1 are valid for the parameters *POS norm position Z* (P402), *POS norm position N* (P403), *POS reference point* (P432) und *RFG polarity* (P017).

- **Setting the relevant global parameters**

In parameter *POS mode* (P406) it is possible to enable and disable the software end switch monitoring. For testing the software end switch must UU set on 0001_{hex}. Next the values of the software end switches must be set.

Pay attention to the following condition:

$$POS\ SW\ end\ switch\ 1 < POS\ reference\ point < POS\ SW\ end\ switch\ 2$$

For example the value of *POS reference point* (P432) is set to 655360 UU. The standardization is defined to 1 UU = 1 Increment (see 5.1.1).

The permitted traversing range must for example be restricted to 5 motor revolutions to the left and 10 to the right.

$$\rightarrow POS\ SW\ end\ switch\ 1 = (655360 - 5 * 65536) UU = 327680 UU \quad P439$$

$$\rightarrow POS\ SW\ end\ switch\ 2 = (655360 + 10 * 65536) UU = 1310720 UU \quad P440$$

The deceleration during rapid halt are set parameter *POS rapid halt deceleration* (P408) (see 4.1). In the example the value is set to 20.00 l/ms².

Select by *POS current set number* (P401) the next valid position data for the following calculation of the positioning characteristics, e.g. position data set 1.

The following 3 parameters are described in detail in chapter 4.1.

$$POS\ position\ window\ z.B. \quad 64\ UU \quad P429$$

$$POS\ position\ window\ time\ z.B. \quad 8\ ms \quad P430$$

$$POS\ rounding\ e.g. \quad 0\ ms\ (no\ rounding) \quad P441$$

- **Setting positioning parameter**

The parameters of the first position data set range from P415 to 421, the parameter of the second position data set from P422 to 428.

Example:

The drive rests after the reference run exactly at reference point (= 655360 BE). Is should turn now 6 revolutions right. The positioning data set 1 is selected.

1. possibility: absolute positioning

$$POS\ target\ position\ 1 = (655360 + 6 * 65536)UU = 1048576 UU \quad P415$$

$$POS\ target\ input\ 1 = 0 \quad P416$$

2. possibility: relative positioning

$$POS\ target\ position\ 1 = 6 * 65536 BE = 393216 BE \quad P415$$

$$POS\ target\ input\ 1 = 1 \quad P416$$

The setting of the remaining position data set parameters is independent *POS target input 1*.
The following 3 parameters set out the speed profile when positioning, e.g.

POS positioning speed 1 = 500 l/ms P417

POS positioning acceleration 1 = 5.00 l/ms² P419

POS positioning deceleration. 1 = 1.00 l/ms² P420

The parameters *POS end speed.1* (P418) und *POS dwell time 1* (P421) not yet implemented and therefore it is not necessary to set them!

- **Setting of operation mode**

Parameter M set operation mode (P122) must be set on 1.

- **Drive manager override**

For override of drive manager following input sequence is required.:

M control word = 6 = 0006_{hex} (command stand still) P120

M control word = 15 = 000F_{hex} (command operation override) P120

- **Setting external impulse release**

Please use operation manual in the event of questions relating to plug pin assignment.

- **Starting target position specification**

Additionally bit no. 11 in *M control word* (P120) must be set.

The drive has reached the target position if bit no. 10 is set on 1 in *M status word* (P121). In the example parameter *POS position set value* (P436) displays after finishing the positioning 1048576 UU.

- **Check list for avoiding faults:**

- Drive doesn't start
 - Is the drive released and the external impulse release set?
 - Is M actual operating mode = 1 (P123) ?
 - Is positioning activated, bit no.0 =1 at *POS module state* (P400) ?
 - Is start bit (bit no. 11) in M control word (P120) set ?
 - The parameters P416 respectively 423 (*POS target input 1* bzw. *POS target input 2*) display 0, i.e. absolute positioning is activated. The actual POS position set value (P436) is identical with *POS target input 1* (P415) respectively *POS target position 2* (P422).
 - Is the software end switch control activated; *POS mode* = 1 (P406) ?
 - Is bit no. 4 and 5 in *POS module state* (P400) set to 1 ?
If yes then one of the two software end switches had been activated. For further information look at description of parameter *POS SW end switch 1* und *POS SW end switch 2* (P439 and P440) in chapter 4.1.

- Drive is moving a shorter distance than set
 - Is the software end switch control activated; *POS mode* = 1 (P406) ?
 - Is bit no. 4 and 5 in *POS module state* (P400) set to 1 ?
 - If yes then one of the two software end switches had been activated. For further information look at description of parameter *POS SW end switch 1* und *POS SW end switch 2* (P439 and P440) in chapter 4.1.
- Drive positioned a few increments beside the calculated target position.
 - Was positioned relatively ? (P416 or 423 not equal 0)
 - Was after the last positioning or reference run the state „Operation enabled“ left (impulses not enabled) ?
 - If yes, the deviation was caused by a renewed release of the controller.
- The programming of a value on parameter *POS SW end switch 1* (P439) or *POS SW end switch 2* (P440) wasn't possible.
 - Following condition must be realised:
$$POS\ SW\ end\ switch\ 1 < POS\ reference\ point < POS\ SW\ end\ switch\ 2$$

4.3 Testing the Manual Mode

In the following example the identical settings are valid for the parameters *RFG polarity* (P017), *POS norm position Z* (P402), *POS norm position N* (P403), *POS mode* (P406), *POS rapid halt deceleration* (P408), *POS reference point* (P432), *POS SW end switch 1* (P439) und *POS SW end switch 2* (P440) as in chapter 5.1 and 5.2.

- **Setting the relevant parameters**

The setting of the speed profile during the manual mode is effected by following parameters:

POS inching speed. e.g. 300 l/ms P409

POS inching acceleration. e.g. 4.00 l/ms² P410

POS inching deceleration e.g. 6.00 l/ms² P411

- **Setting of operation mode**

Parameter M set operation mode (P122) must be set on 5 for reference run mode.

- **Programming of the digital inputs**

One digital input must programmed on bit no.11 (inching forward) and another on bit no. 12 (inching backward) of *M control word* (P120).

z.B.:

Digital input 2 for inching forward (turn right)

DI 2 target Pxxx = 120 P374

DI 2 bit selection = 0800_{hex} P375

DI 2 LOW pattern = 0000_{hex} P376

DI 2 HIGH pattern 2 = 0800_{hex} P377

Digital input 3 for inching forward (turn left)

DI 3 target Pxxx = 120 P378

DI 3 bit selection = 1000_{hex} P379

DI 3 LOW pattern = 0000_{hex} P380

DI 3 HIGH pattern = 1000_{hex} P381



NOTE

The setting of 0000_{hex} is required! In parameter DI state (P382) bit 1 and 2 must be set to ensure that the digital inputs 2 and 3 are active.

- **Enable drive manager**

For override of drive manager following input sequence is required:

M control word = 6 = 0006_{hex} (command stand still) P120

M control word = 15 = 000F_{hex} (command operation override) P120

- **Setting external pulse enabling**

Please use operation manual in the event of questions relating to plug pin assignment.

- **Starting inching forward**

Digital input 2 (inching forward) must set bit no. 11 of *M control word*.

→ The drive turns right until the bit is set to 1 and software end switch 2 isn't reached.

- **Starting inching backward**

Digital input 3 (inching backward) must set bit no. 12 of *M control word*.

→ The drive turns left until the bit is set to 1 and software end switch 1 isn't reached.



NOTE

The drive slows down to speed 0 if bit no. 11 and 12 set in *M control*!

- **Check list for avoiding faults:**

- Drive doesn't start

- Is the drive released and the external impulse release set?

- Is M actual operating mode = 5 (P123) ?

- Is positioning activated, bit no.0 =1 at *POS module state* (P400) ?

- Is start bit (bit no. 11) in M control word (P120) set ?

- Are both bit no. 11 and 12 set in M control word (P120)?

- Is the software end switch control activated; *POS mode* = 1 (P406) ?

- Is bit no. 4 and 5 in *POS module state* (P400) set to 1 ?

- If yes then one of the two software end switches had been activated. For further information look at description of parameter *POS SW end switch 1* und *POS SW end switch 2* (P439 and 440) in chapter 4.1.

- The programming of a value on parameter *POS SW end switch 1* (P439) or *POS SW end switch 2* (P440) is not accepted.

- Following condition must be realised:

- $$POS\ SW\ end\ switch\ 1 < POS\ reference\ point < POS\ SW\ end\ switch\ 2$$

- Drive accepted only one direction of rotation

- Is the positive or negative hardware end switch active?

- Is bit no. 0 or 1 set in parameter P433?

- If yes check, whether the drive is really at an end switch.

5 APPLICATION EXAMPLE SPINDLE POSITIONING

In the following example shows the procedure for setting parameters for a type of spindle positioning.

The assembly is depicted below. A spindle-driven slide is to be positioned between both *software end switches* SW1 and SW2. The position of the slide must be identical for both drive units.

The following data is valid for both drive units.

Motor:	$n_n = 3000 \text{ rpm}$
	1 motor revolution \leftrightarrow 65536 increments
	$\rightarrow n_n = 3000 \text{ rpm} * 65536 \text{ increments} / (60 * 1000 \text{ ms/min})$
	$\rightarrow n_n = 3000 \text{ rpm} * 1.092 \text{ increments} * \text{ms/min}$
	$\rightarrow n_n = 3276 \text{ increments/ms}$
Gearbox ratio:	1 : 2,5
Spindle pitch:	6,4 mm
Permissible traversing range:	3000 mm (distance SW1 - SW2)
Encoder:	incremental encoder input 2

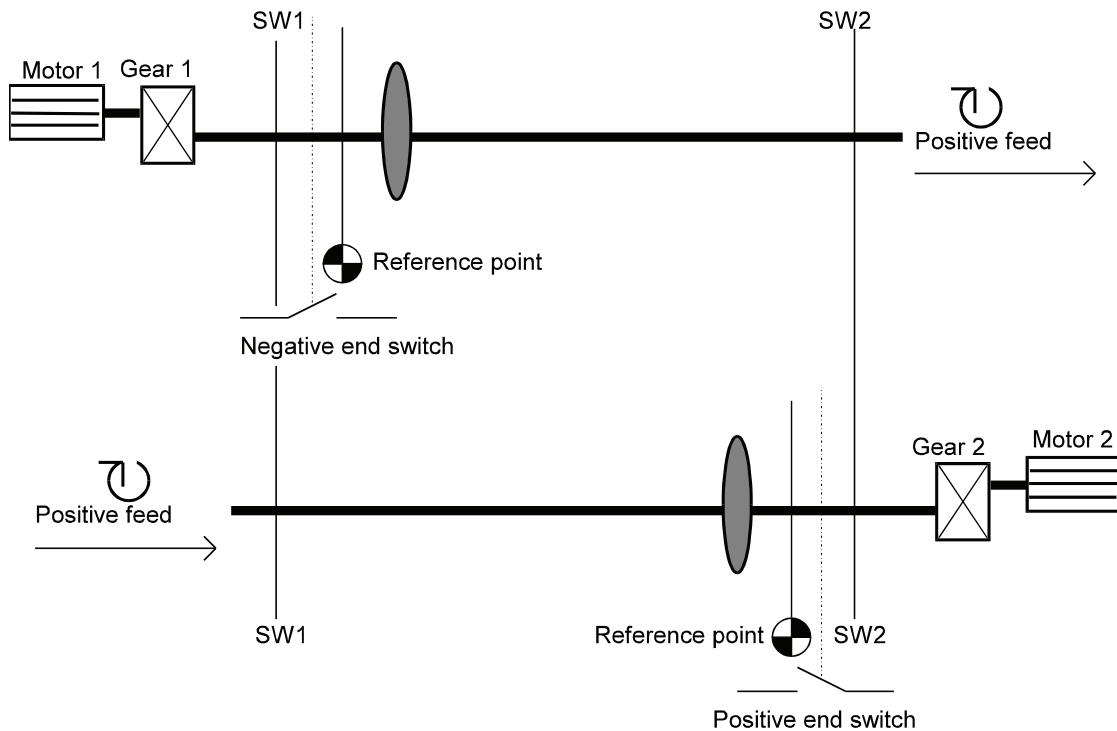

Application Example Spindle Positioning

Following calibration must be applied: $1 \text{ UU} \leftrightarrow 1/100 \text{ mm}$

Calculation of calibration parameters: $1 \text{ motor revolution} \leftrightarrow 65536 \text{ I}$

$1 \text{ motor revolution} \leftrightarrow 2.5 * 6.4 \text{ mm} = 16 \text{ mm}$

$1/100 \text{ mm} \leftrightarrow 65536 \text{ I} * 1/100 \text{ mm} / 16 \text{ mm}$

$1/100 \text{ mm} \leftrightarrow 1 \text{ UU} \leftrightarrow 40.96 \text{ I}$

→ *POS norm position Z* = 4096 P402

→ *POS norm position N* = 100(P403

It is possible to change the direction of rotation with parameter *G2 mode* (P241, Bit no. 1).

Both drive units can be set identically after the reference run, if parameter *G2 mode* is set as follows:

G2 mode = 0020_{hex} for drive unit 1 P241

 = 0022_{hex} for drive unit 2

Rapid halt:

POS rapid halt deceleration e.g. 20.00 I/ms² P408

The rapid halt should be carried out by a digital input.

Programming digital input 0 on *M control word* (P120):

DI 1 target Pxxx = 120 P370

DI 1 bit selection 1 = 4 = 8004_{hex} P371

DI 1 LOW pattern 1 = 32768 = 8000_{hex}[^] P372

DI 1 HIGH pattern 1 = 32772 = 8004_{hex} P373

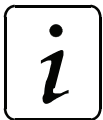

NOTE

The bit no. 15 in *M control word* is the write protection bit. The setting of this bit prevents the *M control word* to UU written over through another communication source before it is processed. The write protection bit is set back automatically.

Settings for the **reference run**:

<i>M control word</i> = 15 = 000F _{hex} = operation enabled	P120
<i>M desired operation mode</i> = 6	P122
<i>POS reference speed</i> . e.g. 500 l/ms	P412
<i>POS reference terminal speed</i> . e.g. 10 l/ms	P443
<i>POS reference acceleration</i> . e.g. 5.00 l/ms	P413 → results in an acceleration time of 100 ms
<i>POS reference deceleration</i> (P442) e.g. 10.00 l/ms	P413 → results in a brake time of 100 ms

Set *POS reference run mode* (P414):

Drive 1:	Movement toward negative end switch ⇒ <i>POS reference run mode</i> = 2101
	<i>POS switch mode</i> = 0 = 0000 _{hex} (P434), because of end switch is normally open (<i>POS switch mode</i> = 2 = 0002 _{hex} , if end switch is normally closed)
	Programming of digital input 2 for end switch on <i>POS switch state</i> (P433):
	<i>DI 2 target Pxxx</i> = 433 P374
	<i>DI 2 bit selection 1</i> = 2 = 0002 _{hex} P375
	<i>DI 2 LOW pattern 1</i> = 0 = 0000 _{hex} P376
	<i>DI 2 HIGH pattern 1</i> = 2 = 0002 _{hex} P377
Drive 2:	Movement toward negative end switch ⇒ <i>POS reference run mode</i> = 2101
	<i>POS switch mode</i> = 0 = 0000 _{hex} (P434), because of end switch is normally open (<i>POS switch mode</i> = 2 = 0002 _{hex} , if end switch is normally closed)
	Programming of digital input 2 for end switch on <i>POS switch state</i> (P433):
	<i>DI 2 target Pxxx</i> = 433 P374
	<i>DI 2 bit selection 1</i> = 2 = 0001 _{hex} P375
	<i>DI 2 LOW pattern 1</i> = 0 = 0000 _{hex} P376
	<i>DI 2 HIGH pattern 1</i> = 2 = 0001 _{hex} P377

The position values of the reference points must be determined. In this example the distance between the reference points must be measured additionally to reach at identical position set values identical spindle positions.

e.g. distance between reference points 2800 mm ↔ 280 000 UU

⇒ Drive 1:	<i>POS reference point</i> = 110 000 UU	P432
⇒ Drive 2:	<i>POS reference point</i> = 390 000 UU	P432

Starting reference run: *M control word* bit no. 4 is additionally set → 31 = 001F_{hex}

If bit no. 12 is set in *M status word* the reference run is finished → 1037_{hex}



NOTE

Shift the reference point with the *encoder offset* (P435) if several reference runs effect in two reference points.

Application Example Spindle Positioning

Setting **software end switches**:

Permitted traversing range 3000 mm ↔ 300 000 UU

⇒ *POS SW end switch 1* = 100 000 UU P439

⇒ *POS SW end switch 2* = 400 000 UU P440

Settings for **manual mode**:

M control word = 15 = 000F_{hex} = operation enabled P120

M desired operation mode = 5 P122

POS inching speed e.g. 200 l/ms P409

POS inching acceleration e.g. 5.00 l/ms² P410 → results in an acceleration time of 40 ms

POS inching deceleration e.g. 10.00 l/ms² (P411) → results in an acceleration time of 20 ms

Starting inching forward: Additionally set bit no. 11 in *M control word* ⇒ 2063 = 080F_{hex}

Starting inching backward: Additionally set bit no. 12 in *M control word* ⇒ 4111 = 100F_{hex}

Setting parameters for **target specification mode**:

M control word = 15 = 000F_{hex} = operation enabled P120

M desired operation mode = 1 P122

POS position tolerance range e.g. 4 UU P429

POS position tolerance range time e.g. 2ms P430

POS current set number e.g. 1 P401

Example: Setting parameters of a **positioning data set**:

The drive 1 has reached after reference run an actual position set value (110000 UU). The drive should be positioned (absolute positioning) at 250000 UU. The positioning time must be minimized.

→ *POS target position 1* = 250000 UU P415

→ *POS target input 1* = 0 (absolute positioning) P416

→ *POS position speed 1* = 3276 l/ms (3000 rpm) P417

The motor allows following acceleration values:

→ *POS position acceleration. 1* = 20.00 l/ms² P419

→ *POS position deceleration. 1* = 24.00 l/ms² P420

Starting positioning: Additionally set bit no. 11 in *M control word* ⇒ 2063 = 080F_{hex}

The positioning is finished if bit no. 7 is set in *POS module state* ⇒ 0081_{hex}

The target position is reached, if bit no. 10 is set in *M status word* ⇒ 0437_{hex}

Acceleration time t_B in ms

Deceleration time t_V in ms

Time with maximum speed - t_K in ms

Total traversing time t_{ges} in ms

Maximum speed v in I/ms

Total movement s in UU

Displacement in acceleration stage s_B in UU

Displacement in deceleration stage s_V in UU

Displacement with maximum speed s_K in UU

Acceleration a_B in I/ms²

Deceleration a_V in I/ms²

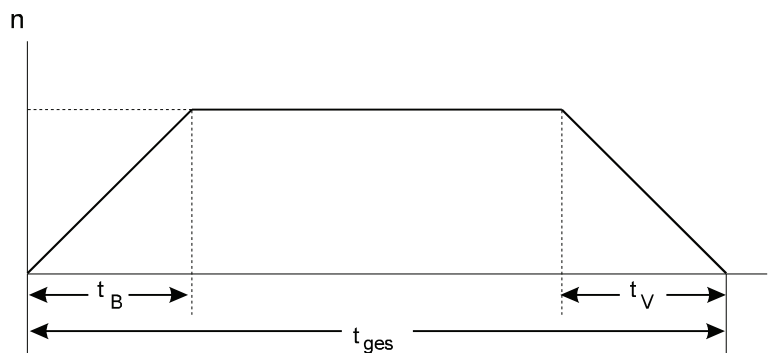

Speed / time curve

$$t_B = \frac{v}{a_B} = \frac{3276 \frac{\text{I}}{\text{ms}}}{20 \frac{\text{I}}{\text{ms}^2}} \approx 164 \text{ms};$$

$$t_V = \frac{v}{a_V} = \frac{3276 \frac{\text{I}}{\text{ms}}}{24 \frac{\text{I}}{\text{ms}^2}} \approx 137 \text{ms}$$

$$s = 250\,000 \text{ UU} - 110\,500 \text{ UU} = 139\,500 \text{ UU (displacement)}$$

$$s_B = 0,5 \cdot a_B \cdot t_B^2 = 0,5 \cdot 20 \cdot \frac{\text{I}}{\text{ms}^2} \cdot (164 \text{ms})^2 = 268960 \text{ I} = 268960 \text{ I} \cdot \frac{100 \text{UU}}{4096 \text{ I}} \approx 6566 \text{ UU}$$

$$s_V = 0,5 \cdot a_V \cdot t_V^2 = 0,5 \cdot 24 \cdot \frac{\text{I}}{\text{ms}^2} \cdot (137 \text{ms})^2 = 225228 \text{ I} = 225228 \text{ I} \cdot \frac{100 \text{UU}}{4096 \text{ I}} \approx 5498 \text{ UU}$$

$$s_K = s - s_V - s_B = (139500 - 5498 - 6566) \text{UU}; \quad s_K \approx 127436 \text{ UU}$$

$$t_K = \frac{s_K}{v} = \frac{127436 \text{ UU}}{3276 \cdot \frac{\text{I}}{\text{ms}}} \cdot \frac{4096 \text{ I}}{100 \text{ UU}} \approx 1594 \text{ ms}$$

$$t_{ges} = t_B + t_V + t_K = (164 + 137 + 1594) \text{ ms} = 1895 \text{ ms};$$

The aforementioned calculations are valid for a continuous position set pre-set.

The results correspond, however, with sufficient accuracy, to those for discrete set pre-set.

6 APPENDIX

6.1 Index

A

Application Example Spindle Positioning 41

B

Basic Setting 5

C

Commissioning 5

Control Word 6

D

Drive Manager 5

DRIVECOM 9

E

Encoder Systems 3

G

Global Parameters 15

I

Inching operation 7

Installation 3

M

Manual Mode 7, 16

Move to the Negative End Switch 11

Move to the Negative Zero Point Transfer Switch 13

Move to the Positive End Switch 12

Move to the Positive Zero Point Transfer Switch 12

P

Parameter 15

Parameter List 29

Position Controller 5

Positioning 8

Positioning Data Set Parameters 26

Producer Defined Reference Run 10

R

Reference Run 9, 16

Reference Run Mode 7

S

Setting the Parameters 5

Single Axis Positioning 3

Standardization 16

State Word 6

Structure of the Positioning 3

T

Target Position Specification Mode 6, 16

Testing operating mode target position specification 35

Testing Operation Mode 31

Testing operation mode reference run 31

Testing the Manual Mode 38

be in motion

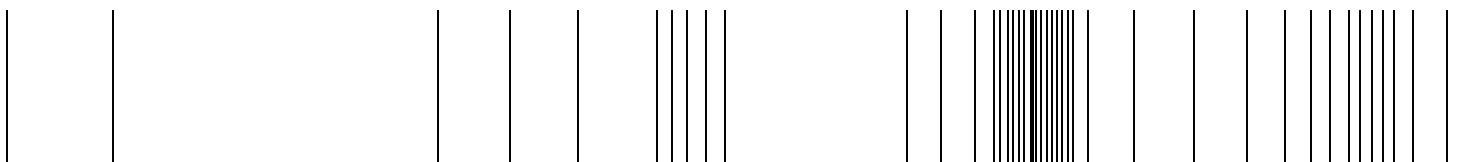

Baumüller Nürnberg GmbH Ostendstraße 80-90 90482 Nürnberg T: +49(0)911-5432-0 F: +49(0)911-5432-130 www.baumueller.de

All information given in this manual is customer information, subject to change without notice. We reserve the right to further develop and actualize our products continuously using our permanent revision service. Please notice, that specifications/data/information are current values according to the printing date. These statements are not legally binding according to the measurement, computation and calculations. Before you make any information given in this manual to the basis of your own calculations and/or applications, please make sure that you have the latest edition of the information in hand. No liability can be accepted concerning the correctness of the information.