

be in motion be in motion

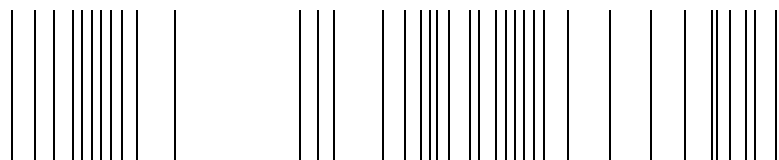

**Technology
Modules**

**Position Control and
Synchronization V-Controller**

Operating instructions

E	5.96187.09a
----------	-------------



BAUMÜLLER

Title	Operating instructions
Product	Technology Modules Position Control and Synchronization V-Controller
Version	5.96187.09a
Copyright	<p>These operating instructions may be copied by the owner in any quantity but only for internal use. For other purposes these operating instructions and extracts thereof may not be copied or reproduced.</p> <p>Use and disclosure of information contained in these operating instructions are not permitted.</p> <p>Designations and company marks contained in these operating instructions may be brand names, the use of which by third parties for their own purposes may violate the rights of the holders.</p>
Obligatory	<p>These operating instructions are part of the equipment/machine. These operating instructions must be available to the operator at all times and must be in a legible condition. If the equipment/machine is sold or moved to a different location these operating instructions must be passed on by the owner together with the equipment/machine.</p> <p>After any sale of the equipment/machine this original and all copies must be handed over to the buyer. After disposal or any other end of use this original and all copies must be destroyed.</p> <p>When the present operating instructions are handed over, corresponding sets of operating instructions of a previous version are automatically invalidated. Please notice that specifications/data/information are current values according to the printing date. These statements are not legally binding according to the measurement, computation and calculations.</p> <p>Baumüller Nürnberg GmbH reserves the right, in developing its products further, to change the technical specifications and the handling of the products concerned without prior notice.</p> <p>No liability can be accepted concerning the correctness of the operating instructions unless otherwise specified in the General Conditions of Sale and Delivery.</p>
Manufacturer	<p>Baumüller Nürnberg GmbH Ostendstr. 80 - 90 D-90482 Nürnberg Germany Tel. +49 9 11 54 32 - 0 Fax: +49 9 11 54 32 - 1 30 www.baumueller.de</p>



Inhaltsverzeichnis

1	Safety notes	5
1.1	General information	5
1.2	Danger information	5
1.3	Qualified personnel	6
1.4	Application as directed	6
2	Commissioning the position control	7
2.1	Functional description	7
2.1.1	Encoder systems	8
2.1.2	Controlled by	8
2.2	Structure	9
2.3	Process sequence	9
2.3.1	Absolute positioning sequence (target input = 0)	11
2.3.2	Normal relative positioning sequence (target input = 1 or -1)	12
2.4	Hardware requirements	13
2.5	General commissioning	14
2.6	Homing	15
2.6.1	Defining the home position	16
2.6.2	Defining the homing method	16
2.6.3	Programming the digital input	18
2.6.4	Changing the operating mode to homing (LR)	19
2.7	Manual operation	20
2.8	Positioning	21
2.9	Data security	23
2.10	Stand-alone mode	24
3	Parameters – Position control	29
3.1	Global parameters	29
3.2	Positioning record-specific parameters	46
4	Testing the ‘position control’ modes	49
4.1	Testing the Homing mode	49
4.2	Testing the Target position input mode	53
4.3	Testing the Manual mode	55
5	Comparison of the positioning modes	57
5.1	Profiles of positioning modes	57
5.2	Comparison	59
6	Example of a position control application	61
6.1	Examples	61
7	Spindle positioning (M19)	67
7.1	List of parameters	68
7.2	Diagrams spindle positioning	70
8	Commissioning the synchronization control	73
8.1	Functional description	73
8.2	Structure	74
8.3	Hardware requirements	74
8.4	Commissioning	76

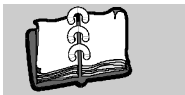

Inhaltsverzeichnis

- 8.4.1 Speed synchronization / relative angle synchronization 78
- 8.4.2 Electronic gear unit 79
- 8.4.3 Data security 80
- 8.4.4 Stand-alone mode 80
- 9 Parameters - Synchronization control 83**
 - 9.1 List of parameters 83
 - 9.2 Description of synchronization modes 88
 - 9.3 Overview of synchronization modes 89
- Appendix A - Abbreviations 93**
- Appendix B - List of parameters 97**
- Table of Figures 99**
- Index 101**

SAFETY NOTES

1.1 General information

These operating instructions contain the information required for the application as directed of the products described herein. The document is intended for specially trained, skilled personnel who are well-versed in all warnings and maintenance activities. The units are manufactured using the state-of-the-art technology and are safe in operation.

TM Position Control and Synchronisation can be installed safely and commissioned and function without problems if the safety information below is observed.



DANGER

When operating this electrical unit, some parts of the equipment always carry dangerous voltage.

Ignoring these safety instructions and warnings may result in death, serious personal injury and/or damage to material assets.

Only qualified personnel who are familiar with the safety information, assembly, operation and maintenance instructions may carry out work on this unit

1.2 Danger information

One the one hand, the information below is for you own personal safety and on the other to prevent damage to the described products or to other connected units.

In the context of the operating instructions and the information on the products themselves, the terms used have the following meanings:

1.3 Qualified personnel



DANGER

Danger indicates an imminently hazardous situation which, if not avoided, **will** result in death or serious injury.



WARNING

Warning indicates a potentially hazardous situation which, if not avoided, **could** result in death or serious injury.



CAUTION

Caution used with the safety alert (exclamation point in triangle) symbol indicates a potentially hazardous situation which, if not avoided, **may** result in minor or moderate injury.



NOTE

This is a substantial information.

1.3 Qualified personnel

Qualified personnel in the sense of the safety-relevant information in this document or on the products themselves, qualified personnel are considered to be persons who are familiar with setting up, assembling, commissioning and operating the product and who have qualifications appropriate to their activities.

- Trained or instructed or authorised to commission, ground and mark circuits and equipment in accordance with recognised safety standards.
- Trained or instructed in accordance with recognised safety standards in the care and use of appropriate safety equipment.

1.4 Application as directed



WARNING

You may only use the unit/system for the purposes specified in the operating instructions and in conjunction with the third-party equipment and components recommended or authorised by Baumüller Nürnberg GmbH.

For safety reasons, you must not change or add components on/to the unit. The operator must report immediately any changes that occur which adversely affect the safety of the unit/system.

2

COMMISSIONING THE POSITION CONTROL

These commissioning instructions are designed to assist you in parameterising the *position control* of the V-controller with the help of WinBASS in a way allowing standalone positioning (operation without WinBASS) via switch signals. Rerouting to the machine is possible through triggering using relay contacts or digital outputs (higher-level control).

2.1 Functional description

A standard feature of the operating system, the *position control* of the V-controller positions an axis and can be used for

- linear positioning or
- rotary-table positioning
- a trapezoidal profile or a S-curve can be chosen as speed profile.

The positioning data (e.g., setpoint position, positioning speed, positioning acceleration etc.) are stored in two positioning records.

The positioning data can be modified

- statically (before positioning begins) or
- dynamically (only with trapezoidal profile).

In dynamic positioning, a new setpoint position is handed over during travel. Transition from old to new setpoint position is compensated by a special computing algorithm.

The target position may be specified as

- absolute,
- relative to the target position or
- relative to the actual position ('flying positioning').

2.1 Functional description

The *position control* is designed with a freely selectable scaling factor to allow setpoint position entry in machine-readable quantities such as mm or degrees, so that machine-specific position parameters may be converted to internal Baumüller scaling standards. These machine-specific values (such as setpoint position, home position) are identified by the abbreviation UU for user units.

2.1.1 Encoder systems

The actual position can be detected with the help of one of the following encoder systems:

- **Incremental encoders:** Rectangular-wave incremental encoder, sine-wave incremental encoder

or

- **absolute encoders:** Single-turn encoder (resolver, SCS70, SRS50), multi-turn encoder (SCM70, SRM50)

Since both the incremental encoder and the resolver (in the case of several motor revolutions) supply only relative position data, homing is necessary before positioning may start (absolute drive position-to-travel reference). Single-turn absolute encoders (resolvers, SCS70, SRS50) supply absolute position data only within one (motor) revolution.

To establish this reference, the user is offered several homing method options (method selection is dependent on the application).

During active positioning, drive motion may be restricted through freely adjustable software limit switches. Once the drive reaches such a software limit switch, it is decelerated, and an error signal is generated.

In addition to the Positioning and Homing modes of operation, the *position control* also offers the manual operating mode. Once this operating mode has been activated, the drive may travel within the software limit switch end positions with the help of the 'Jogging+' and 'Jogging-' commands, to set up a machine, for example.

2.1.2 Controlled by

The *position control* is controlled either by use of

- the digital inputs of the V-controller,
- a field bus interface, or
- by means of an Ω mega-DriveLine.

Parameterisation and how to start the individual functions of the *position control* is explained below.

2.2 Structure

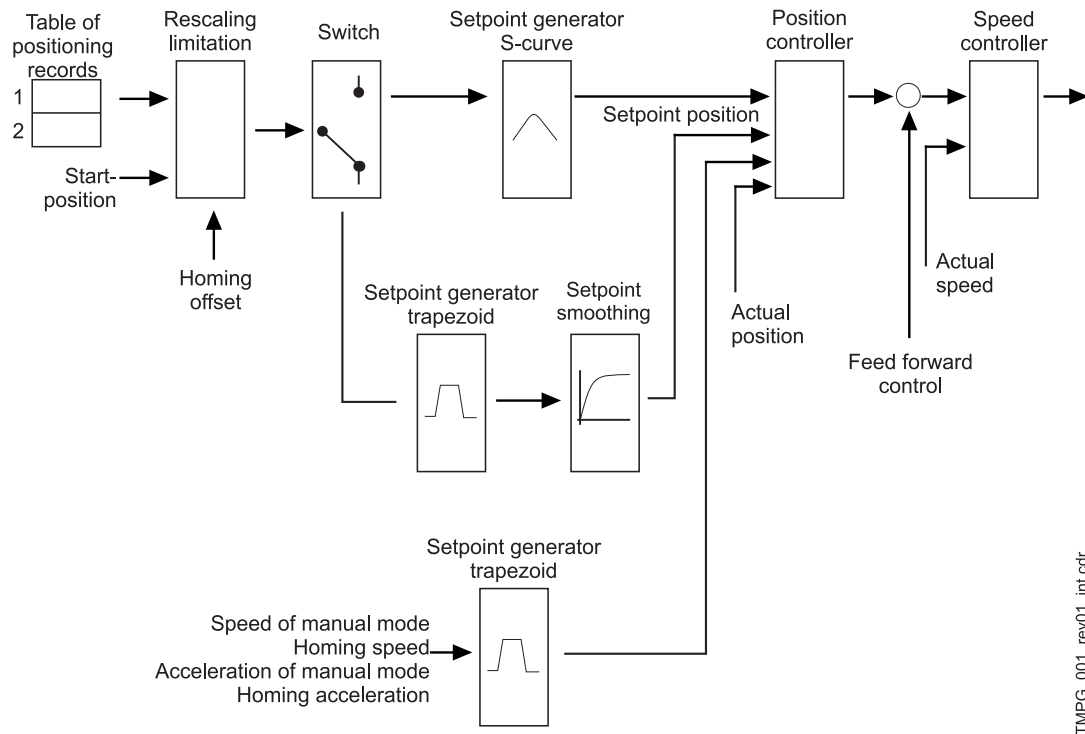

Figure 1: structure of module position control

TMPG_001_rev01_int.cdr

2.3 Process sequence

At the beginning of the positioning process, a positioning record (P 401) is selected and/or a positioning record transmitted. The command *Start positioning* (bit no. 11 in the control word) starts the positioning process.

The start bit must always be set to start a positioning process. Positioning is then completed independently of the start bit.

Dependent on parameter *Target input* (P 416 or P 423), this start bit is subject to the following differences:

- The start bit may remain set continuously for absolute limited target input (target input = 0, restricted to maximum travel width), and positioning will then always be for the current absolute target position. This means that only new (absolute) target positions must be written while the start bit is set.
- The normal relative target inputs (target input = 1, -1), however, are dependent on the positive edge of the start bit. A new target position is generated relative to the old target position once the positive edge of the start bit appears.
- The flying relative target inputs (target input = 2, -2) are also dependent on the positive edge of the start bit. A new target position is generated relative to the actual position once the positive edge of the start bit appears.
- Absolute unlimited target inputs (target input = 3, not restricted to maximum travel width) result in positioning in the direction of the shorter travel to the target. The maximum travel range may be exceeded if the SW limit switch is off.

Target positions may be modified at any time.

With trapezoidal profile even if the drive is currently in motion, it can start positioning for the new target position immediately, if the target dependent condition for the start bit is fulfilled. Any changes to positioning record, positioning speed, positioning acceleration and positioning deceleration are also effective immediately and independent on the parameter target input (P 416 or P 423).

With S-curve you can do this, too. But the data is not valid till the bit "function completed" is set.

Once the drive controller has accepted the start command, the drive starts positioning, and *Target position reached* (bit no. 10 in the status word) changes to 0.

Should the position control detect a quick stop request, the drive decelerates to standstill as per parameter M QUICKSTOP – code (P 131) and switches positioning off. Once operation is re-enabled and a new start requested, the drive repositions for the original target position in **absolute** positioning mode.

2.3.1 Absolute positioning sequence (target input = 0)

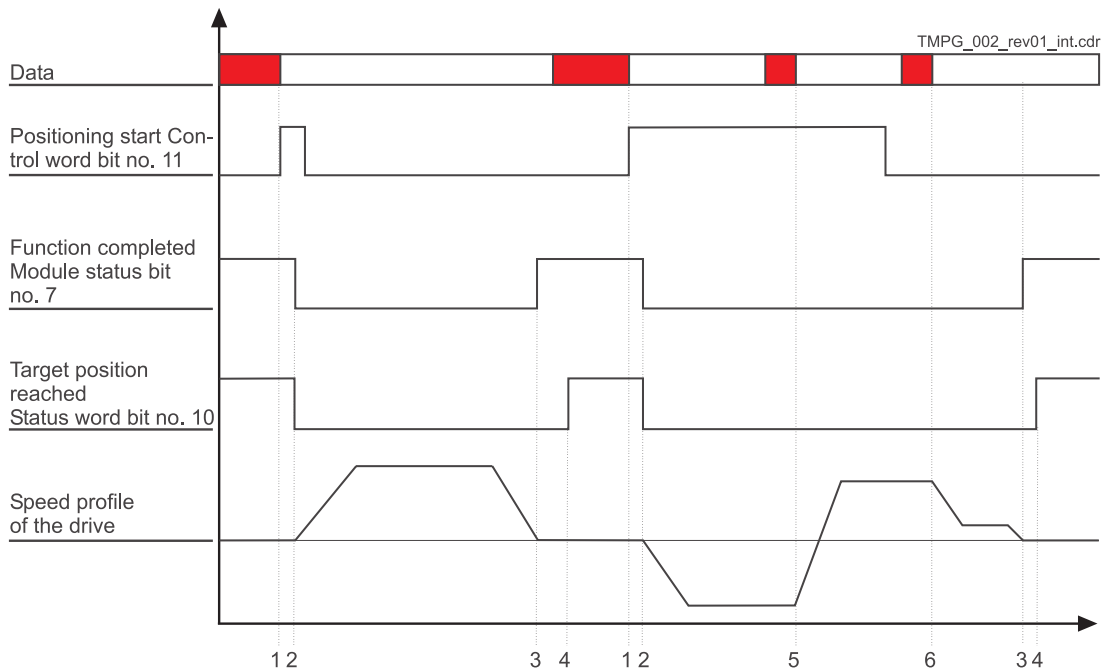

Figure 2: target input = 0 (absolute positioning sequence)

Description of transitions:

Transition	Description	Explanation
1	<i>Start positioning</i> L ⇒ H	Positioning data valid; start request transmitted to control word.
2	<i>Function completed</i> H ⇒ L and <i>Target pos. reached</i> H ⇒ L	Positioning is started. <i>Start positioning</i> can be reset. A delay of 3 to 11 ms occurs between (1) and (2)!
3	<i>Function completed</i> L ⇒ H	Setpoint input through ramp generator completed. Note: Further setpoint positions can still be output via the rounding generator; see POS Module status bit no. 15.
4	<i>Target pos. reached</i> L ⇒ H	Will be set, dependent on the set pos. window and in accordance with the pos. window time, as <i>Function completed</i> later.
5	New target position valid	Start bit set; new target position transmitted or the pos. record was changed (the example therefore shows a reversal).
6	New pos. speed valid	A new positioning speed was transmitted or the pos. record was changed.



NOTE

Bit no. 11 in the control word does not need to be set for in-process changes to the current positioning speed or the current acceleration data.

2.3 Process sequence

2.3.2 Normal relative positioning sequence (target input = 1 or -1)

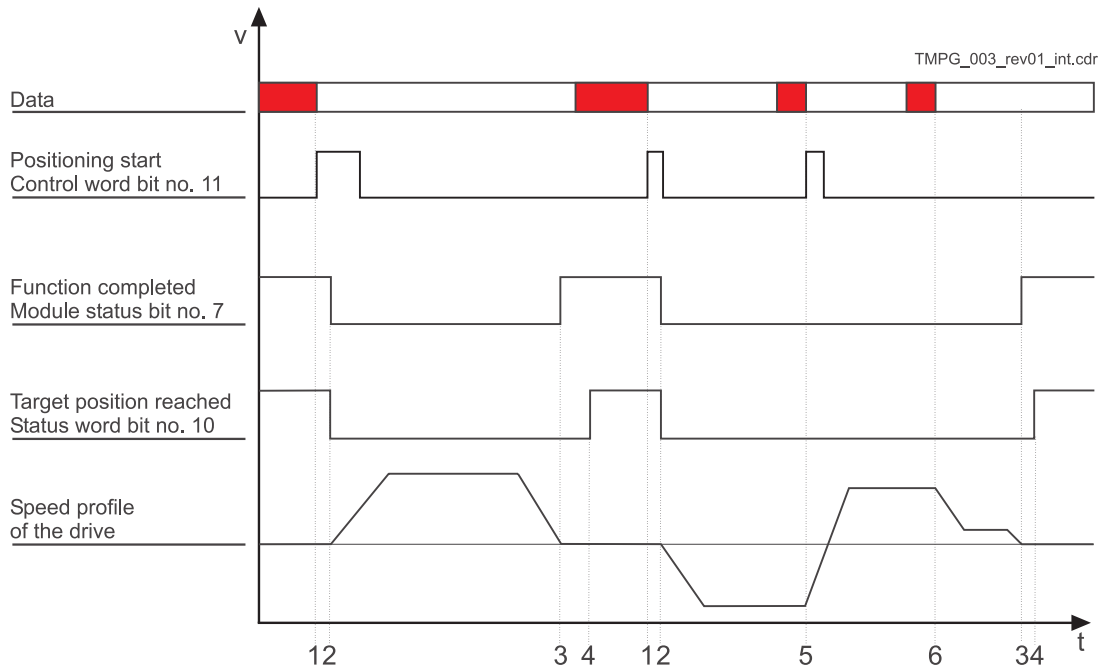

Figure 3: target input = 1 or -1 (relative positioning sequence)

Description of transitions

Transition	Description	Explanation
1	<i>Start positioning</i> L ⇒ H	Positioning data valid; start request transmitted to control word.
2	<i>Function completed</i> H ⇒ L and <i>Target pos. reached</i> H ⇒ L	Start edge detected in bit no. 11 of the control word. Positioning is started. <i>Start positioning</i> can be reset. A delay of 3 to 11ms occurs between (1) and (2) !
3	<i>Function completed</i> L ⇒ H	Setpoint input through ramp generator completed. Note: Further setpoint positions can still be output via the rounding generator; see POS Module status bit no. 15.
4	<i>Target pos. reached</i> L ⇒ H	Will be set, dependent on the set pos. window and in accordance with the pos. window time, as <i>Function completed</i> later.
5	New target position valid	New target position transmitted, target input modified, or the pos. record was changed. Start bit will be reset. The new travel path will be added to the previous one (the example shows a reversal as the target input changed from +1 to -1, for example).
6	New pos. speed valid	A new positioning speed was transmitted or the pos. record was changed.



NOTE

Bit no. 11 in the control word does not need to be set for in-process changes to the current positioning speed or current acceleration data.

2.4 Hardware requirements

Commissioning the *position control* with one drive unit requires a specific mechanical setup.

The diagrams below show the mechanical and electrical setups that formed the basis for the commissioning example.



DANGER

Observe the safety regulations, outlined in the documentation for the individual components, throughout all commissioning activities.

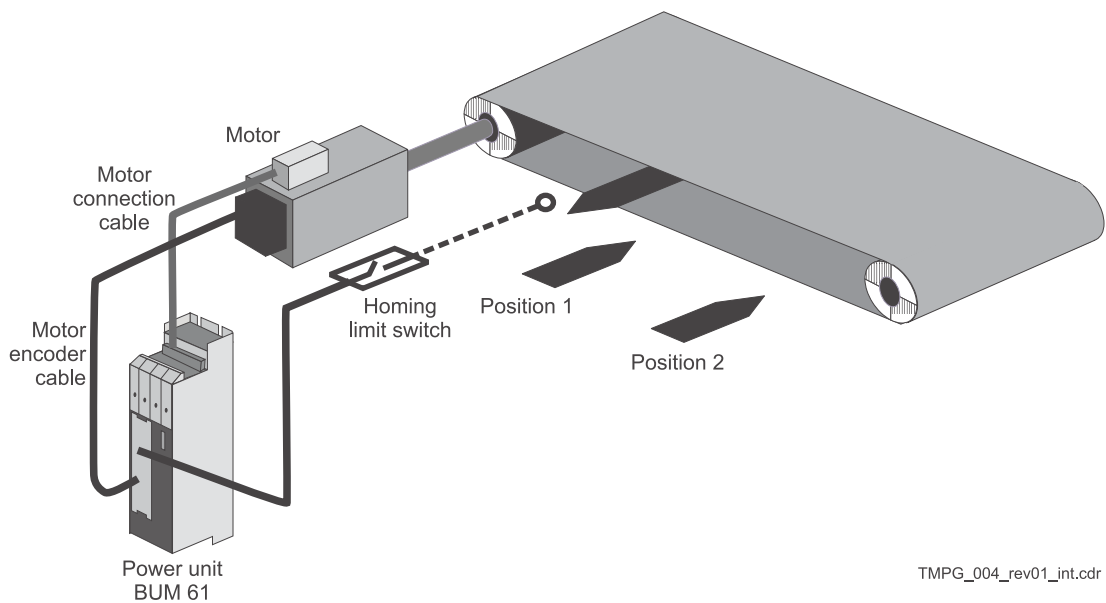

Figure 4: Positioning - mechanical setup

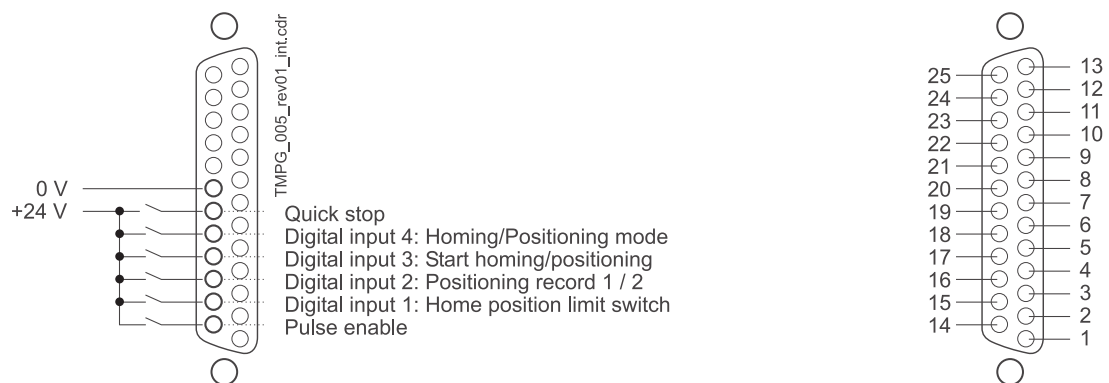

Figure 5: Positioning - electrical terminating resistor connector X26

Prerequisite for operation of the *position control* is a completed initial commissioning of the drive unit (see V-controller initial commissioning with WinBASS).



DANGER

During initial commissioning, make sure that the drive can rotate freely and that there are no mechanical obstructions.

Once your drive unit has been successfully commissioned for the first time, you may now start commissioning the *position control*.

All parameter settings that will not be changed during the subsequent commissioning process, have already been set to functional defaults by the interactive commissioning. Should you wish to make any changes to these settings, refer to the description of parameters (see ▶Parameters – Position control◀ from page 29) for an explanation of the parameter and its setting options.

2.5 General commissioning

Now that you have connected and checked your components in accordance with the circuit diagrams ▶Hardware requirements◀ from page 13, apply the supply voltages and start the controller operating program WinBASS to display the WinBASS start window.

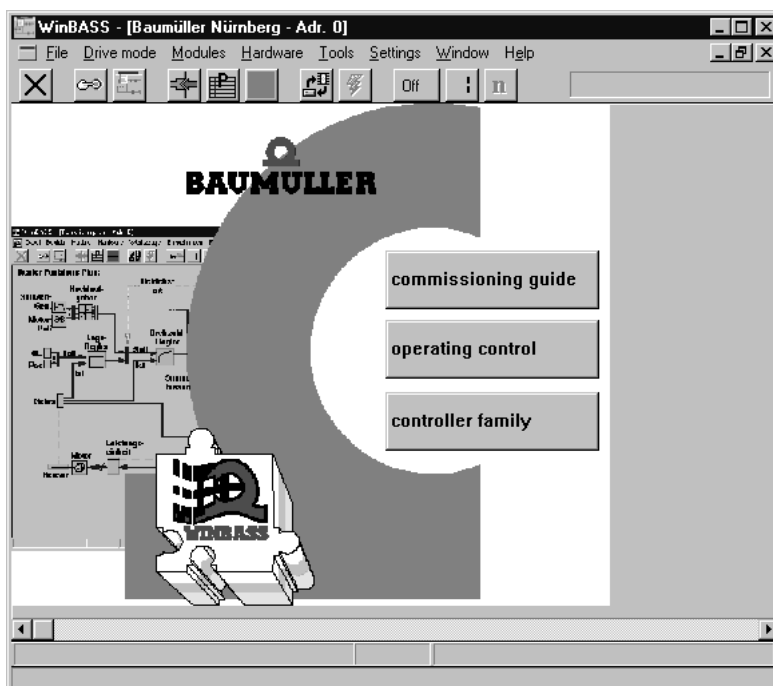

Click the button in the menu bar to establish communication with the controller. Once communication has been successfully established, the button changes its display from **Off** to **On**, and ongoing communication is indicated by a rotating green segment.

Now click the button **Controller operation** in the screen centre to display the controller functional diagram.

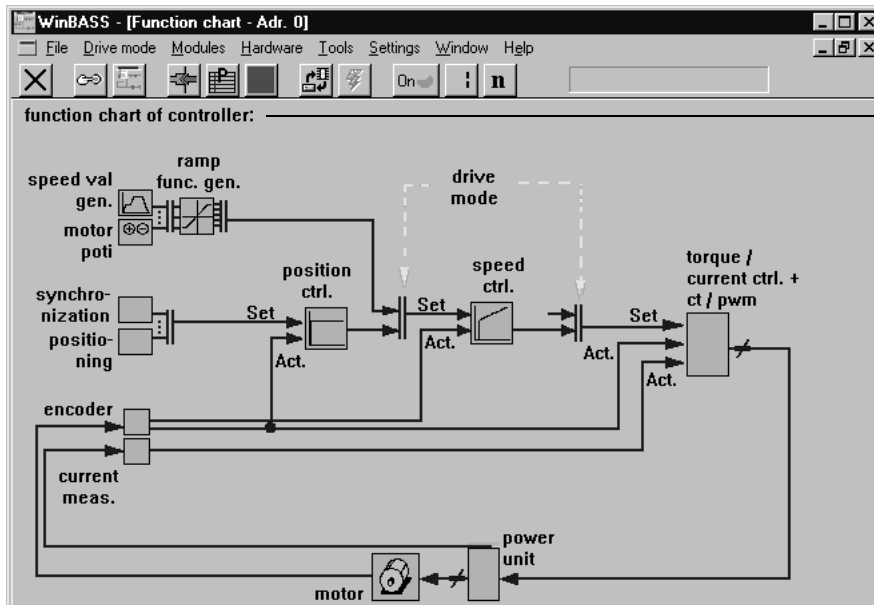

Window name

Click the function block **Position control** in the window **Functional diagram** to display the window **General positioning**. From this window you can access all functions of the *position control*.

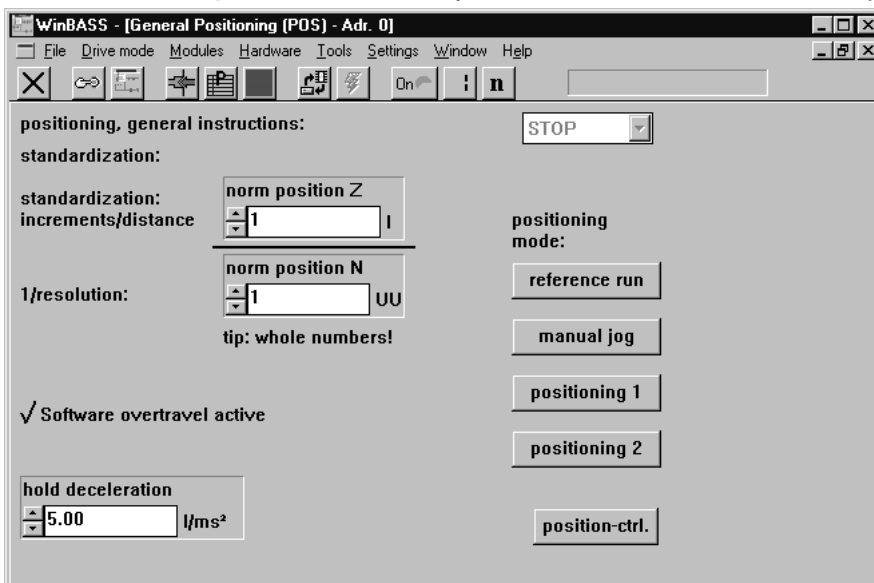

In this window you set the scaling of machine-specific values to the internal scaling. Entries in parameter **Position-scaling N** specify the number of increments that correspond to the operator-defined value set in parameter **Position-scaling D**. One motor revolution is divided into 65536 increments (independent of the encoder system). In our example, a 1/1 ratio has been set so that 65536 UU (user units) correspond to one motor revolution.

2.6 Homing

For an absolute drive position-to-travel reference, it is necessary in our example to perform homing (the mounted resolver merely supplies absolute position data within one motor revolution). Homing must be repeated after every time the controller is switched on so that the absolute position reference may be stored in the controller (revolutions and angle data).

2.6 Homing

Click the button **reference run** to display the window **Homing**.

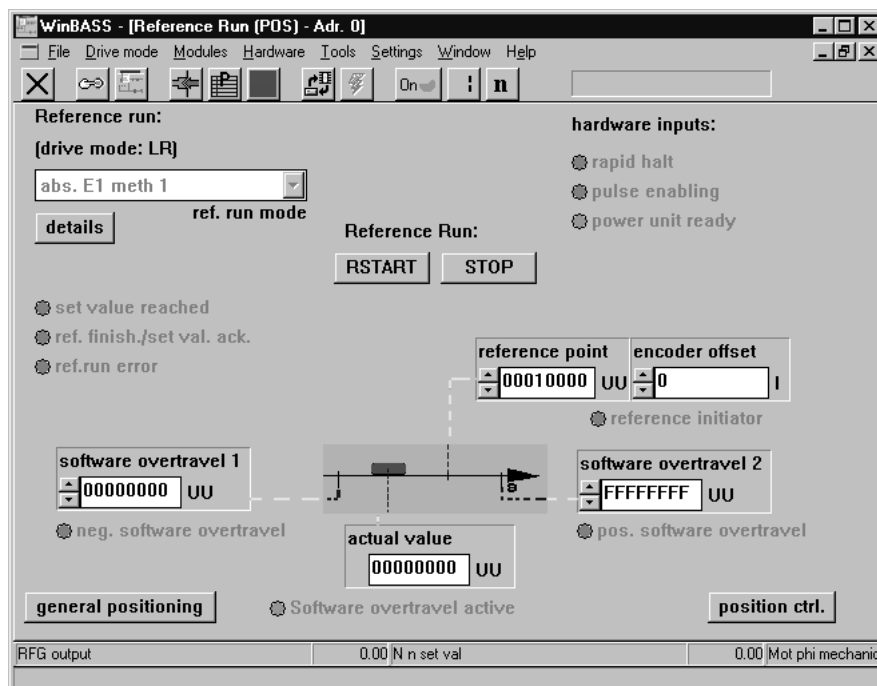

The following preliminary adjustments must be made before homing can start:

2.6.1 Defining the home position

Entry of the hex value 00010000_{hex} in the parameter 'Home position' defines the home position in absolute terms.

Composition of position data such as home position, for example:

The value 00010000_{hex} UU corresponds to 65536_{dec} .UU. The decimal value in UU must still be converted into increments (65536_{dec} . increments = 1 motor revolution).

65536_{dec} .UU x scaling = 65536_{dec} .UU x 1inc./1UU = 65536_{dec} .inc.= 1 motor revolution.

2.6.2 Defining the homing method

Homing method -4 was defined on the basis of the mechanical setup (negative limit switch) and the type of limit switch used (for a more detailed description of the methods refer to the description of parameters in chapter ▶Parameters – Position control◀ from page 29). To select this method, click the button **details** to display the window **Homing details**.

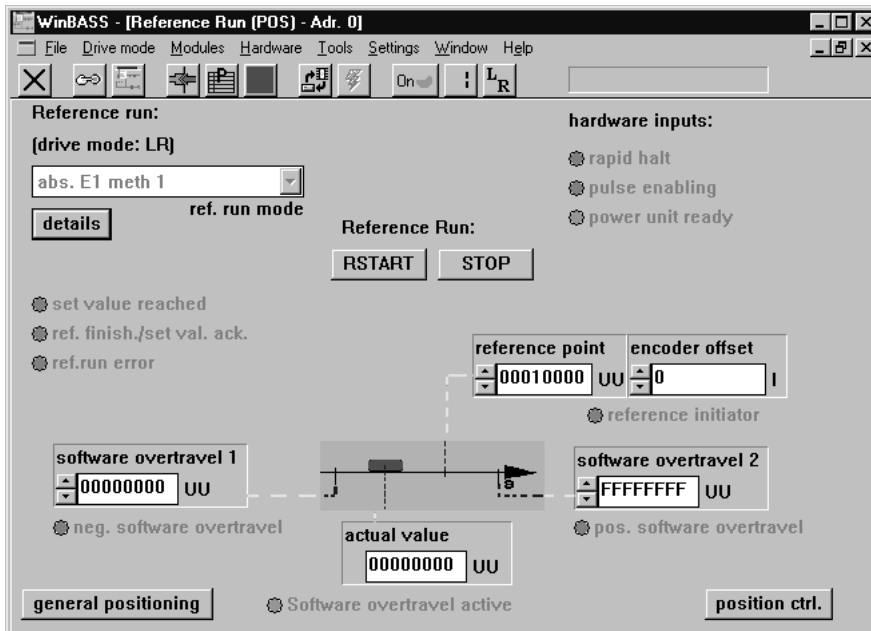

Click the button **mode** to display a selection window

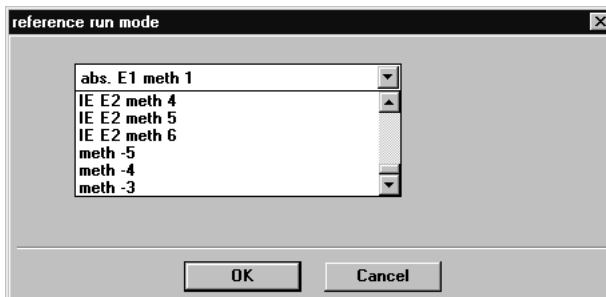

Select the defined homing method from the list field and confirm your selection by clicking **OK**. Click the button **X** in the menu bar to close the window **Homing details** and return to the window **Homing**.

2.6.3 Programming the digital input

to which the home position limit switch is connected.

To program digital input 1, go to the pulldown menu **Hardware** and select **Inputs**.

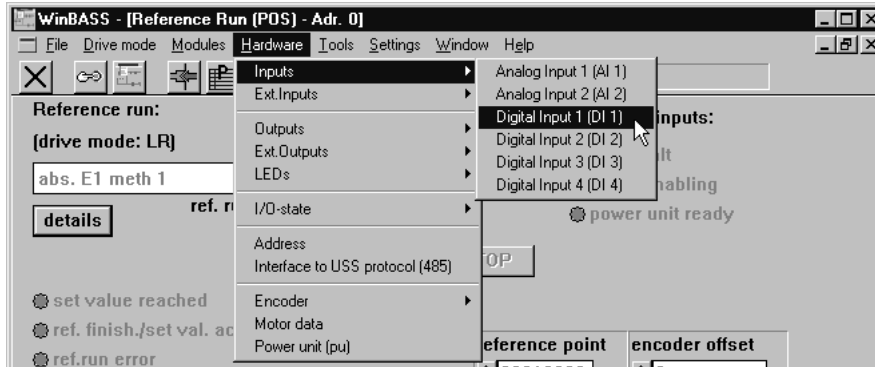

In the displayed submenu, select the menu item **Digital input 1 (DI1)** to open the programming window for this input.

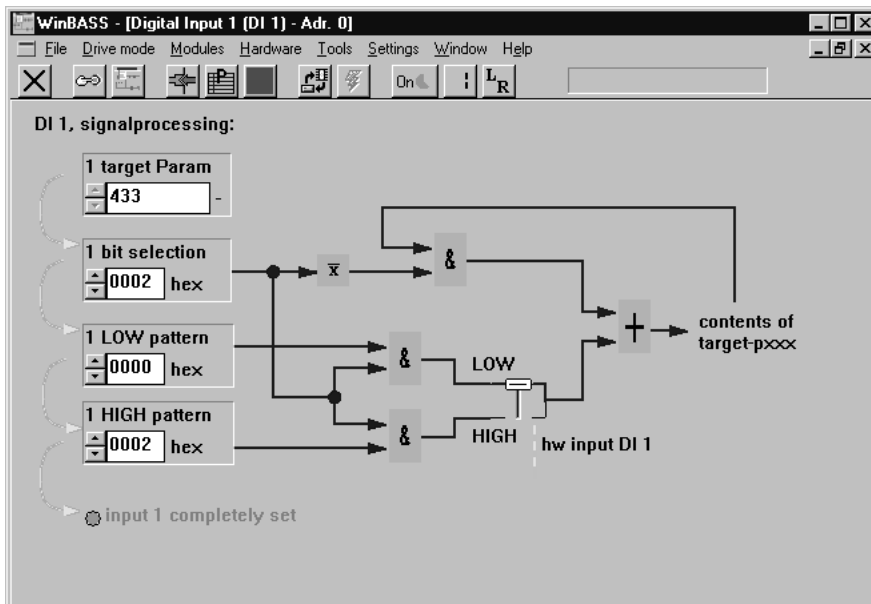



Now enter the above values one after the other into the fields **1 target param**, **1 bit selection**, **1 LOW pattern** and **1 HIGH pattern**. Once the values have been entered correctly (re-enter even those values that do not appear to change), the LED **Input 1 fully parameterised** comes on for confirmation. This programming maps the home position limit switch status to parameter 433 (refer to the description of parameters in chapter ▶Parameters – Position control◀ from page 29) of the V-controller. Click the button  in the menu bar to close this window and to return to the previous window **Homing details**.

2.6.4 Changing the operating mode to homing (LR)

For homing purposes, you must change the V-controller operating mode. For this purpose, click the button  (operating mode selector) in the menu bar to display an operating mode selection window. Select the operating mode **Homing mode (LR)** from the list field, and confirm your selection by clicking **OK**.

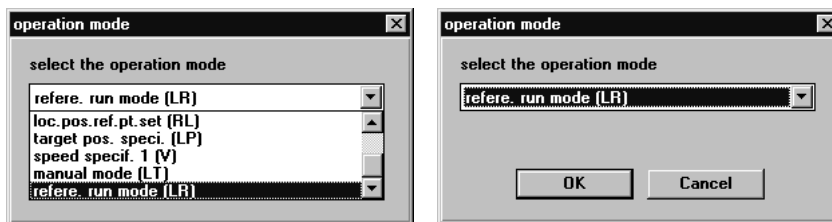
At a later stage, we will select the operating mode with the help of a suitably programmed digital input



The operating mode selector button in the menu bar now changes its display accordingly: 

Now that all preliminary settings have been made, you may start homing the drive. To start this process, you must set the hardware enable options at the controller (first quick stop, then pulse enable) and then click the button **RSTART**. The motor now moves the tool carriage in the direction of the homing limit switch until that is operated (the exact homing sequence is detailed in chapter ▶Parameters – Position control◀ from page 29). Completion of homing is signalled by illumination of the display **Homing completed/setpoint acknowledged**. Now click the button **STOP** to switch the hardware enable options off.

Your drive is now homed, and you may continue with your commissioning activities.

2.7 Manual operation

Manual operation is for manual drive movement. Simple button operation moves the drive even without setpoint position. This is helpful for the setup of a machine or for determination of later-required setpoint positions, for example.

Now click the button  in the menu bar to close the window **Homing** to return to the previous window **General positioning**.

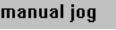
Then click the button  to display the window for Manual operation

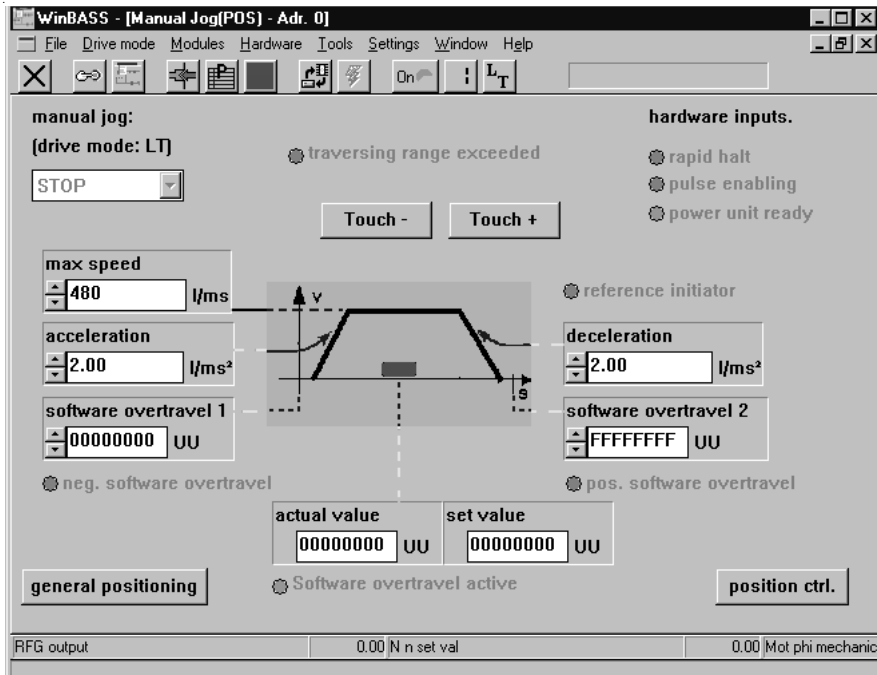

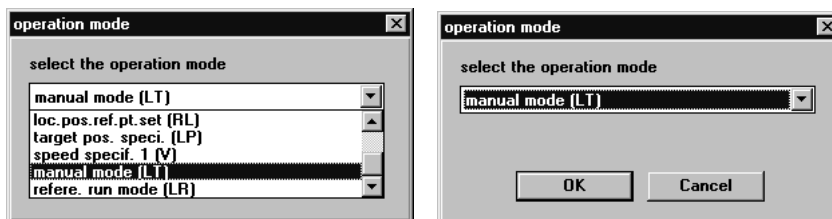

To move the drive in manual mode, you must change the V-controller operating mode. For this purpose, click the button  (operating mode selector) in the menu bar to display an operating mode selection window. Select the operating mode **Manual mode (LT)** from the list field, and confirm your selection by clicking **OK**.



The operating mode selector button in the menu bar now changes its display accordingly: .

To start manual operation, you must now set the hardware enable options at the controller (first quick stop, then pulse enable). The positioning carriage can now be moved within the limits set by the software and/or hardware limit switches (for settings refer to the description of parameters, chapter ▶Parameters – Position control◀ from page 29).

Click the button  to increase the drive's setpoint position (positive setpoint input), and the button  to decrease the drive's setpoint position (negative setpoint input), and the drive will be positioned as specified.

Releasing the relevant button returns the drive to standstill.

Where the setpoint position data are unknown for later positioning, the data of future setpoint positions may be determined by approaching them. The current actual position is displayed in the window by parameter

actual value
00000001 UU

Switch the hardware enable options off again once manual operation is completed.

2.8 Positioning

Before positioning can begin, you must define the setpoint positions (target positions). This example uses two absolute setpoint positions (absolute positioning): The first setpoint position 00020000_{hex} (1 revolution from home position) and the second setpoint position 00030000_{hex} (2 revolutions from home position).

Now click the button in the menu bar to close the window **Manual operation** to return to the previous window **General positioning**.

Now click the button **position point1** to display the window **Positioning 1**.

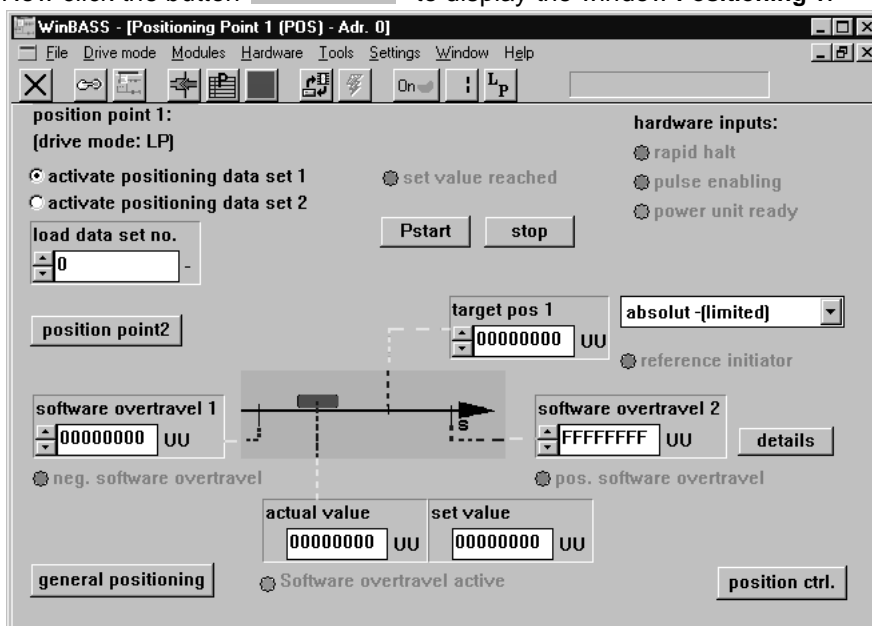

2.8 Positioning

Under **Target position 1**, enter the first setpoint position UU . Then click the button **position point2** to open the window **Positioning 2**.

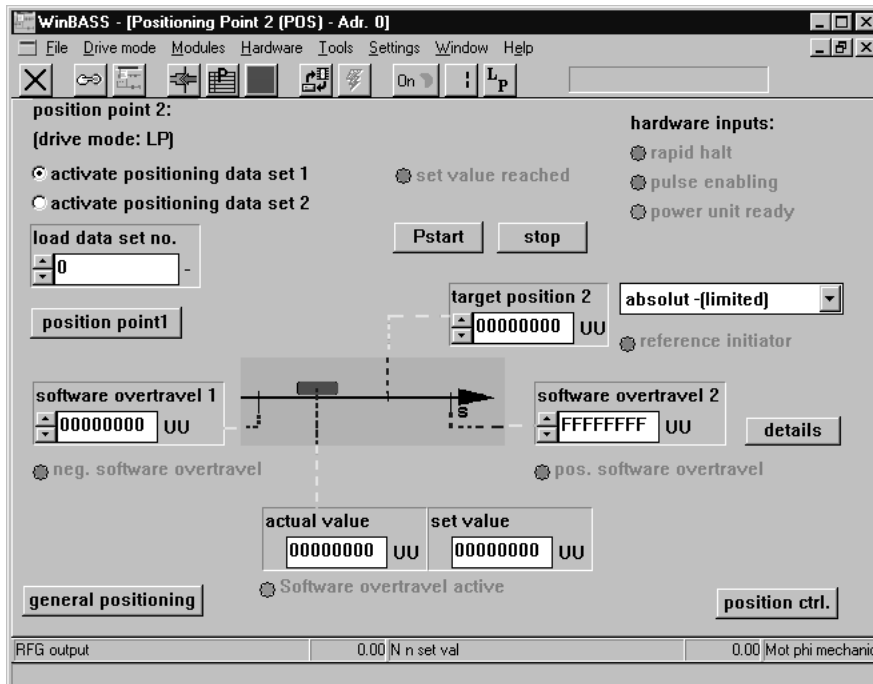

Under **Target position 2**, enter the second setpoint position UU . Then click the button **position point1** to return to the window **Positioning 1**.

You must also change the V-controller operating mode.

For this purpose, click the button (operating mode selector) in the menu bar to display an operating mode selection window. Click the operating mode **Target position input (LP)** from the list field, and confirm your selection by clicking **OK**.

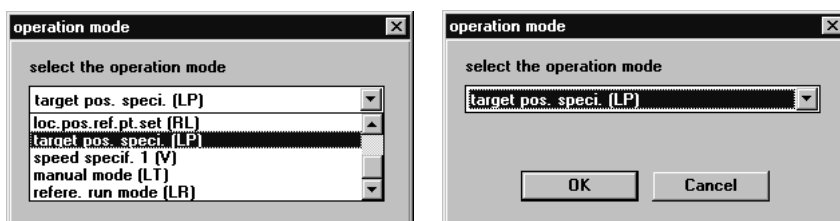

The operating mode selector button in the menu bar now changes its display:

To start positioning, you must now set the hardware enable options at the controller (first quick stop, then pulse release). Click the button , and the positioning carriage will move to target position 1. Completion of the positioning process is signalled by illumination of the display **Setpoint reached** above the button **Pstart**.

Now click the button **Activate positioning record 2** at the top left.

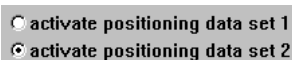

Immediately after activation, the positioning carriage moves to target position 2. Activation of positioning record 1 causes the drive to return to target position 1. You may repeat this until you click the **Stop** button.

At a later stage, we will select the positioning record with the help of a suitably programmed digital input.

Switch the hardware enable options off again once positioning mode is completed.

2.9 Data security

Store your set data in the non-volatile memory of the controller to avoid their loss after the controller is switched off.

For this purpose, click the button  (data record administration) in the menu bar to display the window **Data record administration**.

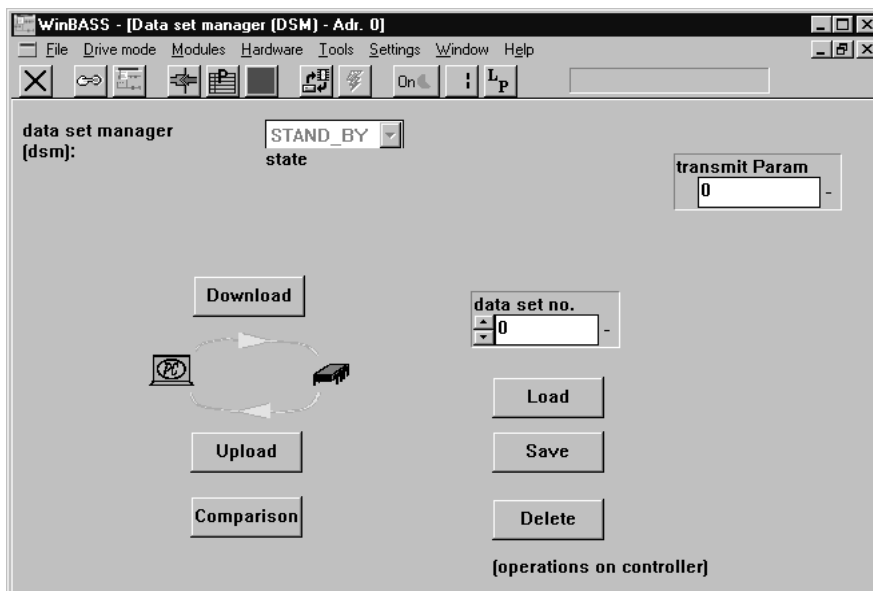

Click the button **Save** to save the programmed data, storing the parameters in data record 0 (= boot data record = the data record that is loaded when the equipment is switched on). A confirmation window is displayed after the successful save. Click **OK** to close the window.

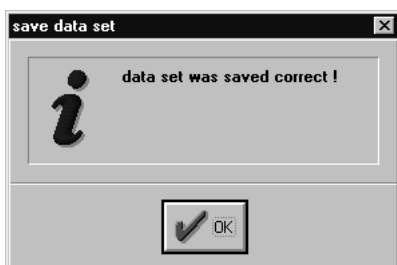

2.10 Stand-alone mode

Once the *position control* has been commissioned with the help of WinBASS, we will now explain the expanded parameterisation of the V-controller, so that you can operate it as a stand-alone unit without WinBASS.

For this purpose, you must implement the three functions of Changing the operating mode, Start homing/positioning and Selecting the positioning record by means of the digital inputs.

Changing the operating mode

To change the V-controller operating mode without WinBASS in future standalone operation, we will now program a digital input to assume this function.

To program digital input 4, go to the pulldown menu **Hardware** and select **Inputs**.

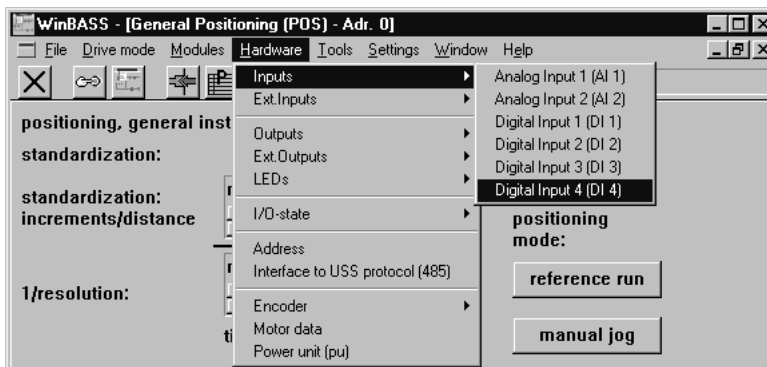

In the displayed submenu, select the menu item **Digital input 4 (DI4)** to open the programming window for this input.

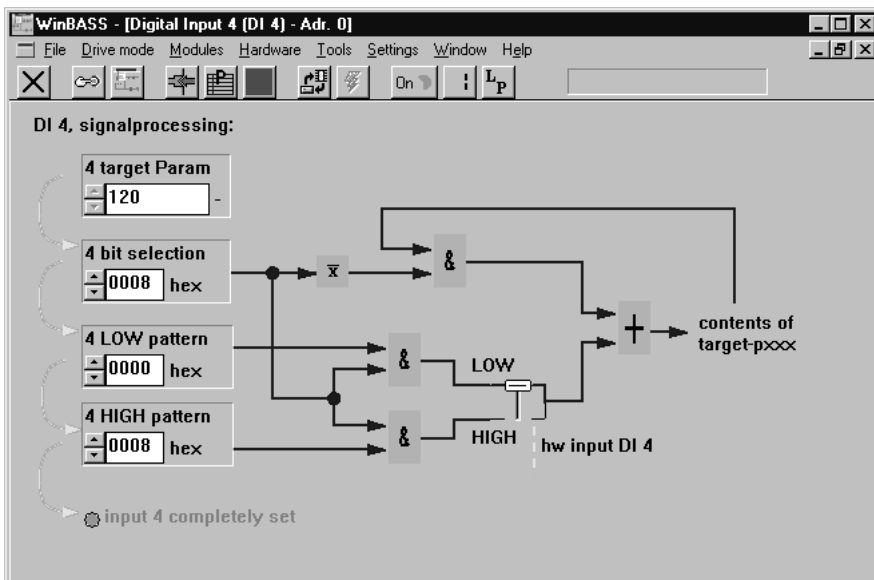

Now enter the above values one after the other into the fields **4 target param**, **4 bit selection**, **4 LOW pattern** and **4 HIGH pattern**. Once the values have been entered correctly, the LED **Input 4 fully parameterised** comes on for confirmation. This parameterisation selects the operating mode 'Homing (LR)' during the Low-to-High status transition, and the operating mode 'Target position input (LP)' during the High-to-Low input status transition.

Click the button  in the menu bar to close this window and to return to the previous window.

Start homing/ positioning

To start homing and/or positioning without WinBASS in future operation, we will now program digital input 3 to assume this function.

To program digital input 3, go to the pulldown menu **Hardware** and click **Inputs**

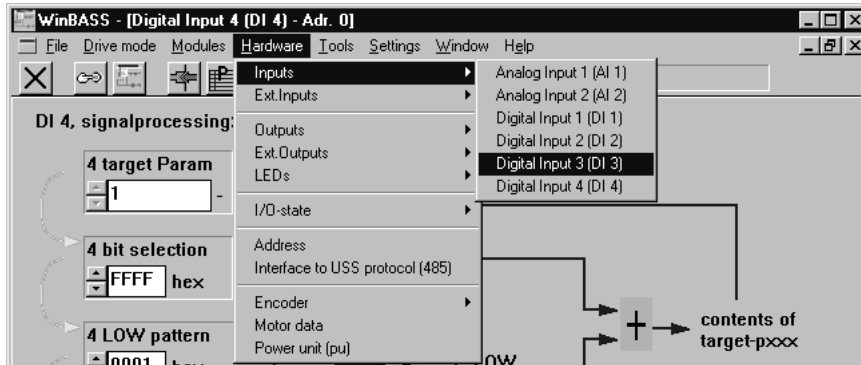

In the displayed submenu, select the menu item **Digital input 3 (DI3)** to open the programming window for this input.

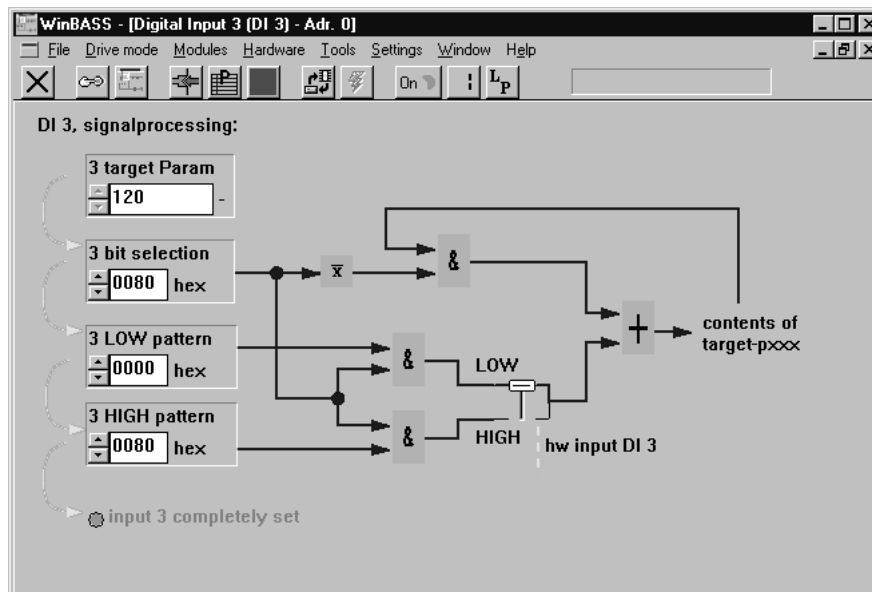

Now enter the above values one after the other into the fields **3 target param**, **3 bit selection**, **3 LOW pattern** and **3 HIGH pattern**. Once the values have been entered correctly, the LED **Input 3 fully parameterised** comes on for confirmation. This parameterisation sets the start bit for homing and/or positioning during the Low-to-High input status transition. The start bits are reset during the High-to-Low status transition (this does not stop the drive, but merely ends the started function).

Click the button  in the menu bar to close this window and to return to the previous window.

Selecting the positioning record

To select a different positioning record without WinBASS in future operation, we will now program digital input 2 to assume this function.

2.10 Stand-alone mode

To program digital input 2 go to the pulldown menu **Hardware** and select **Inputs**.

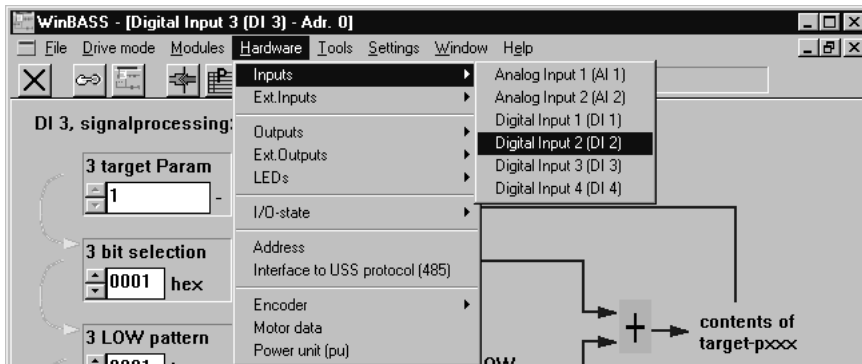

In the displayed submenu, select the menu item **Digital input 2 (DI2)** to open the programming window for this input.

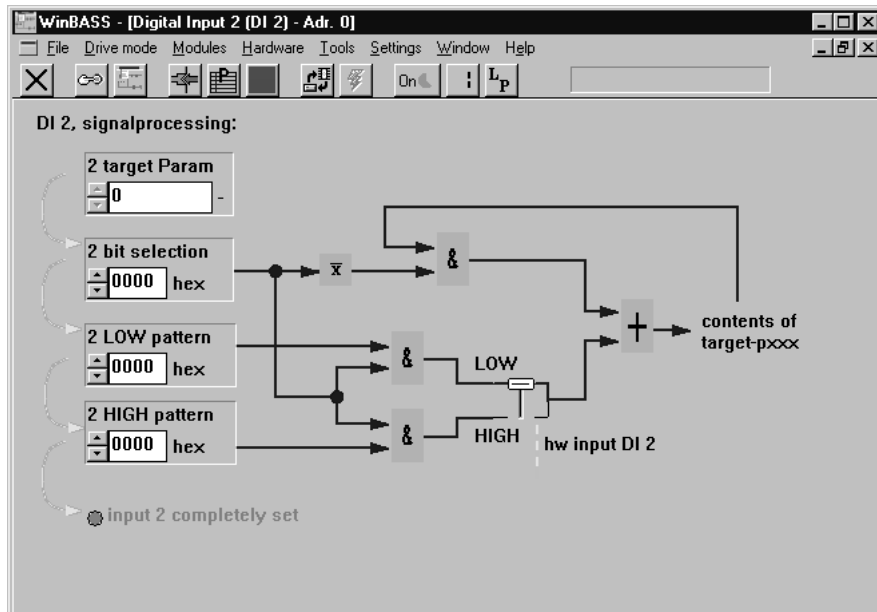

Now enter the above values one after the other into the fields **2 target param**, **2 bit selection**, **2 LOW pattern** and **2 HIGH pattern**. Once the values have been entered correctly, the LED **Input 2 fully parameterised** will come on for confirmation. This parameterisation selects positioning record 1 during the Low-to-High input status transition, and positioning record 2 during the High-to-Low status transition.

Click the button  in the menu bar to close this window and to return to the previous window.

Setting the communication source Control access (communication source) by use of RS232/BASS must be disabled for stand-alone operation so that the V-controller does not wait for commands from WinBASS. For this purpose, select the drive manager by clicking the button  (operating status display).

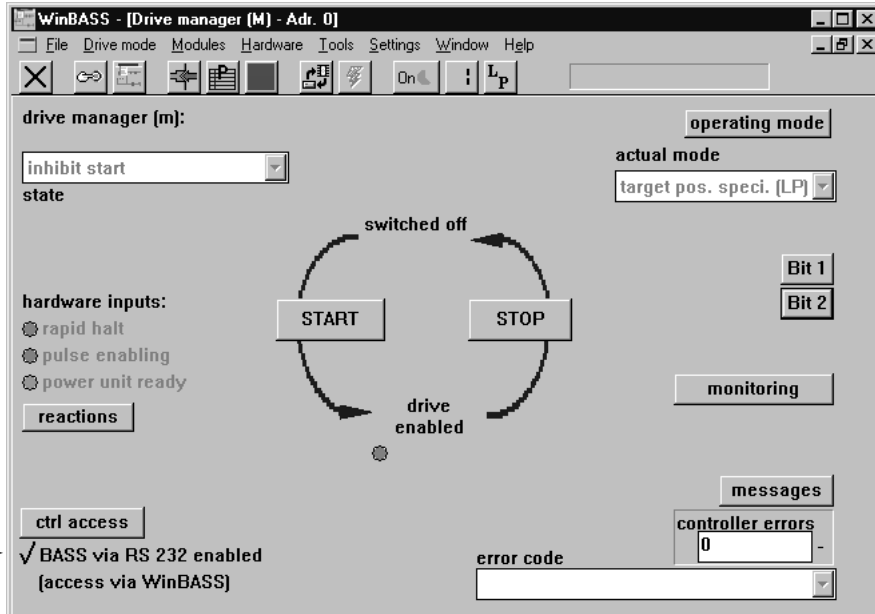

Control access by use of RS232/BASS is currently enabled. Click the tick to disable this function.

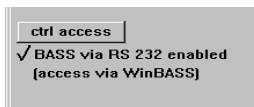

Click the button  in the menu bar to close this window and to return to the previous window.

Save the data record to avoid data loss through equipment disconnection (refer ▶ Data security ◀ on page 23).

2.10 Stand-alone mode

Once you have implemented all the above modifications, drive operation will be as detailed in the chart below:

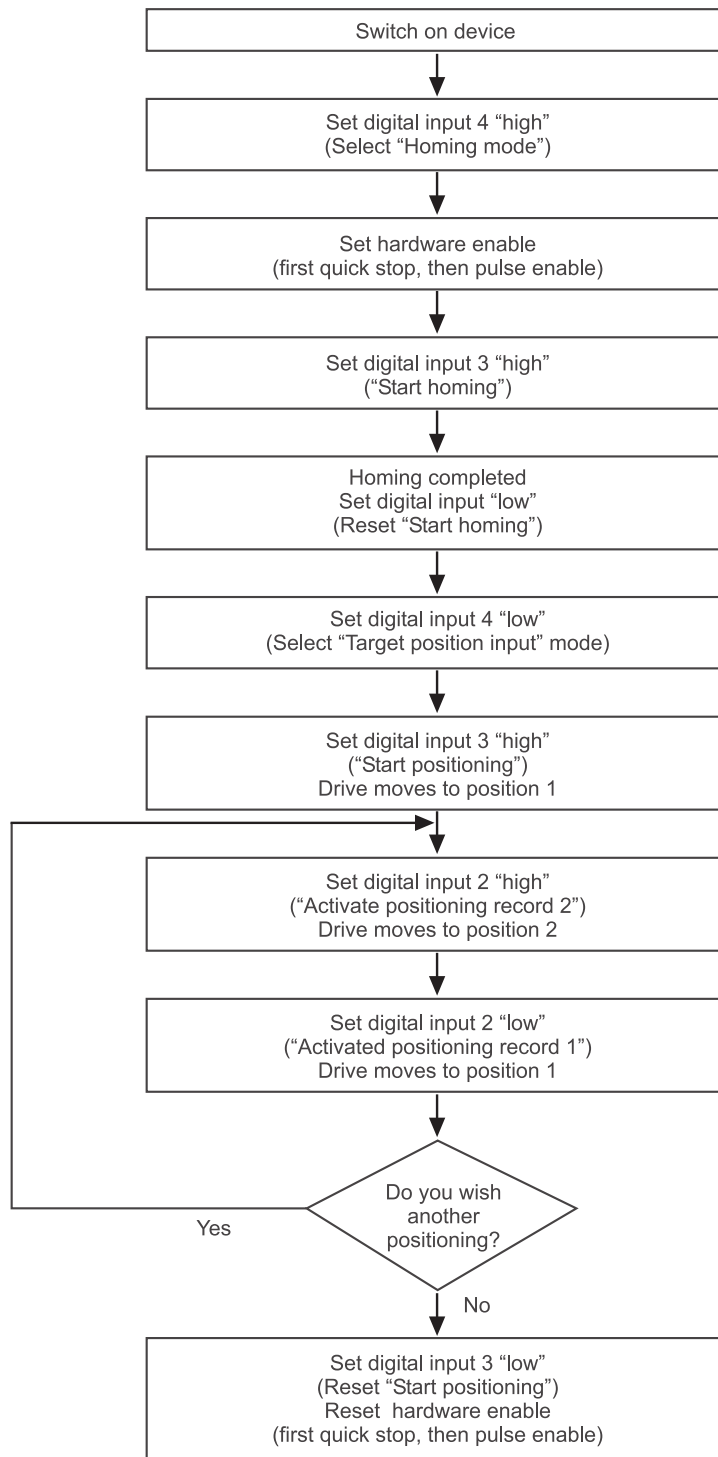

TM/PG_006_rev01_int.cdr

Figure 6: drive operation - chart (stand-alone mode positioning)

3

PARAMETERS – POSITION CONTROL

Parameters relevant to the position control are divided into global parameters applicable to both positioning records, and positioning record-specific parameters.

3.1 Global parameters

Parameter	Name	Range min. ... max.	Unit	Display only
P 400	POS Module status	0000 ... FFFF		×
P 401	POS Current record number	1 ... 2		
P 402	POS Position scaling N	1 ... 65535	I	
P 403	POS Position scaling D	1 ... 32768	UU	
P 406	POS Mode	0000 ... FFFF		
P 408	POS Stop deceleration	0.25 ... 450.00	I / ms ²	
P 409	POS Jogging speed	1 ... 13200	I / ms	
P 410	POS Jogging acceleration	0.25 ... 450.00	I / ms ²	
P 411	POS Jogging deceleration	0.25 ... 450.00	I / ms ²	
P 412	POS Homing speed	1 ... 13200	I / ms	
P 413	POS Homing acceleration	0.25 ... 450.00	I / ms ²	
P 414	POS Homing mode	-2199 ... 2199		
P 429	POS Pos. window	0 ... FFFF FFFF	UU	
P 430	POS Pos. window time	1 ... FFFF	ms	
P 431	POS Backlash compensation	0 ... FFFF FFFF	UU	
P 432	POS Home position	0 ... FFFF FFFF	UU	
P 433	POS Status - switch	0 ... FFFF		×
P 434	POS Mode - switch	0 ... FFFF		

3.1 Global parameters

Parameter	Name	Range min. ... max.	Unit	Display only
P 435	POS Encoder offset	0 ... FFFF	I	
P 436	POS Setpoint position	0 ... FFFF FFFF	UU	×
P 437	POS Actual position	0 ... FFFF FFFF	UU	×
P 438	POS Setpoint speed	-13200 ... +13200	I / ms	×
P 439	POS SW limit switch 1	0 ... FFFF FFFF	UU	
P 440	POS SW limit switch 2	0 ... FFFF FFFF	UU	
P 442	POS Homing deceleration	0.25 ... 450.00	I / ms ²	
P 443	POS Final homing speed	1 ... 50	I / ms ²	
P 444	POS Clip environment 1	1 ... FFFFFFFF	UU	
P 445	POS Clip environment 2	1 ... FFFFFFFF	UU	

I = Increments
UU = User units

**Scaling
speeds and
accelerations:**

1 motor revolution ↔ 65536 increments

$$1000 \frac{\text{I}}{\text{ms}} = 1000 \cdot \frac{60 \cdot 1000 \text{ rev}}{65536 \text{ min}} = 915 \frac{\text{rev}}{\text{min}}$$

P 400

POS Module status

This parameter indicates the status of the position controls. Not all operating modes use the individual bits.

Bit no.	Description	Target position input	Jogging	Homing
0	0: STOP 1: RUN	×	×	×
4	1: SW limit switch 1 active	×	×	
5	1: SW limit switch 2 active	×	×	
7	1: Function completed	×		
8	Reserved			
9	Reserved			
10	1: Pos. scaling N < Pos. scaling D	×	×	×
11	1: Travel range exceeded		×	
12	1: Setpoint reached	×		×
13	1: Clip environment 1 reached	×		
14	1: Clip environment 2 reached	×		
15	1: Setpoint speed = 0	×	×	×

Note:

- Bit 7 is set once the ramp generator has completed its function.

- Bit 11 is set if the maximum permissible travel range is exceeded.
- Bit 12 'Setpoint reached' means 'Target position reached' in the target position input mode, and 'Homing speed reached' in homing mode.
- Bit 15 is set if setpoint speed = 0, i.e., no new position data are written to the position controller input.
For the target position input mode in particular, this means that even the rounding generator has completed its function.
- The bits remain set only as long as the controller is in OPERATION_ENABLED status.

P401**POS Current record number**

This parameter selects the current positioning record

Value	Description
1	Positioning record 1 active
2	Positioning record 2 active

P402**POS Pos. scaling N****P403****POS Pos. scaling D**

These parameters convert the application-specific position parameters to the internal scaling standard (1 motor revolution ↔ 65536 increments).

Application-specific position parameters are all global and all positioning record parameters whose unit includes the abbreviation UU (user unit).

Rescaling using the example of a position input parameter:

$$\text{Input parameter}[I] = \text{Input parameter}[UU] \frac{\text{POS Pos. scaling N}[I]}{\text{POS Pos. scaling D}[UU]}$$



NOTE

- **Condition 1: POS Pos. scaling N \geq POS Pos. scaling D**

If this condition is not met, the scaling parameter last described remains set to its old value, and bit no. 10 in Module status is set.

The bit is reset, and the new scaling accepted, only after one of the two parameters has been changed to meet the condition.

- **Condition 2:** The permissible limits of the application-specific position input parameters decrease by factor $\frac{\text{POS Pos. scaling D}}{\text{POS Pos. scaling N}}$.

The user is responsible for overrange monitoring as the system does not include this function!

- **Condition 3: POS Pos. scaling N + POS Pos. scaling D \leq 65536**

This condition is monitored automatically.

- Rescaling the application-specific input parameters rounds all values down. Positioning is in accordance with the possible degree of computing accuracy, but no position data will be lost through repeated relative positioning.

Scaling factor expansion does not lead to higher resolution, e.g., $\frac{20000}{1000} = \frac{20}{1}$

- **Condition 4:** Scaling can be changed offline only, which means that the controller must be disabled.

P406

POS Mode

This parameter switches the subsequent functions on and/or off.

Bit no.	Description
0	1: SW limit switch function active
1	0: time optimized positioning (trapezoidal profile of speed) 1: jerk limited positioning (S-curve profile of speed)
2 - 15	Reserved



NOTE

This parameter can only be changed in "offline state" of the controller, i.e. the controller must be in a disabled state.

P 4 0 8 POS **Stop deceleration**

This parameter is relevant only in manual mode and becomes effective as soon as the drive overshoots a software or hardware limit switch. The drive will then slow down to zero speed at the set stop deceleration, but retains OPERATION_ENABLED status.

P 4 0 9 POS **Jogging speed**

The jogging speed specifies the drive travel speed in manual mode.

P 4 1 0 POS **Jogging acceleration**

The jogging acceleration describes the maximum drive acceleration in manual mode.

P 4 1 1 POS **Jogging deceleration**

The jogging deceleration specifies the maximum drive deceleration in manual mode.

P 4 1 2 POS **Homing speed**

The homing speed specifies the maximum drive travel speed in homing mode, at which the homing switches are approached.

P 4 1 3 POS **Homing acceleration**

Homing acceleration specifies the maximum drive acceleration in homing mode. The homing deceleration value (P 442) applies for drive deceleration in homing mode.

P 4 1 4 POS **Homing mode**

This parameter specifies the homing sequence including home position approach direction and evaluation of the home sensor..

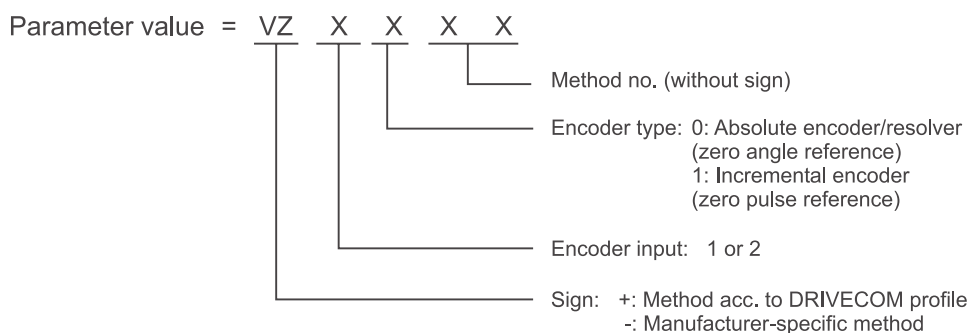

Method = Symbol – method no.

**NOTE**

Specification of encoder type and encoder input is not relevant for methods –3, –4 and –5. The parameter value therefore consists only of the method number.

Homing

As a rule, operation of position-controlled drives requires exact knowledge of the absolute drive position. Homing is necessary where an incremental encoder is used for actual position detection, or where more than one motor revolution is required for the whole travel range for actual-value detection with the help of resolvers. Absolute encoders, too, can be initialised by means of homing. Home position and direction of approach, i.e., the exact homing sequence, is/are set by using parameter *Homing mode* (P 414).

Homing as per the DRIVECOM profile is divided into the following phases:

- Phase 1
In phase 1, travel is at the homing speed defined in parameter P 412.
- Phase 2
Once the home sensor (limit switch or home switch) is reached, the system decelerates to zero at *homing deceleration* (P 442) and accelerates to one eighth of the homing speed (at least *final homing speed* P 443) in the opposite direction of travel. The acceleration is set in parameter *POS Homing acceleration* (P 413).
- Phase 3
The next switch edge triggers deceleration to *final homing speed* (P 443). The encoder angle is detected as soon as the homing module enters this speed.
- Once an encoder zero angle * (= home position) and/or incremental encoder zero pulse has been detected, no new setpoint positions are entered, and the drive remains in its current position. The current angle and home position value (P 432) are now copied to the actual position and setpoint position (P 209 and/or 208) as soon as the POS actual position (P 437) has been in the positioning window (P 429) around the current setpoint position for the time specified in P 430.
- Phase 4 for resolvers / absolute encoders
In phase 4, positioning is now automatically for the home position value. A deviation of up to 0.1° is possible if the home position is approached repeatedly.
- Phase 4 for incremental encoders
The home position shifted by the *encoder offset* (P 043) is now approached at *final homing speed* (P 443).
The following conditions must be met to allow the definition of identical home positions:
 - Once set, homing speed, homing acceleration and deceleration as well as encoder offset must not be modified.
 - The homing speed must be reached in phase 1.

1) In the encoder zero angle, parameter Mot Phi-mechanical (P 030) has a value of 180°.

Manufacturer-specific homing Homing methods -4 and -5 run homing operations that merely use the limit switches for homing.

-4 = Approaching the negative limit switch
 -5 = Approaching the positive limit switch

Manufacturer-specific homing methods -4 and -5 are divided into the following phases:

- Phase 1
In phase 1, travel is at the homing speed defined in parameter P 412.
- Phase 2
Once the limit switch is reached, the system decelerates to zero at *homing deceleration* (P 442) and accelerates to one eighth of the homing speed (at least *final homing speed* P 443) in the opposite direction of travel. The acceleration is set in parameter *POS Homing acceleration* (P 413).
- Phase 3
The next falling edge of the limit switch causes the drive to decelerate again and reverse. Travel towards the limit switch is now at *final homing speed* P 443.
- Phase 4
Once the limit switch is reached, the drive is immediately decelerated to zero speed. The current position corresponds to the home position. The home position value (P 432) is now copied to the actual position and setpoint position (P 209 and 208) as soon as the *actual position* (P 437) has been in the positioning window (P 429) around the current setpoint position for the time defined in P 430.



NOTE

Although homing methods -4 and -5 are not so accurate due to the switching tolerances of the limit switches, it is not necessary to set the *encoder offset* (P 435).

Homing methods -1, -2 and -6 (resolver/absolute encoder) and/or -101, -102 (incremental encoder):

These methods home for the next encoder zero angle and/or zero pulse.

In -1 and/or -101, the drive travels towards the encoder zero angle and/or zero pulse in CW rotation and in -2 and/or -102 in CCW rotation.

In -6, the encoder zero angle is approached by the shortest path, with the speed firmly programmed to *final homing speed* P 443. No home sensor (limit switch or home switch) is necessary.

Homing -3:

The home position value (P 432) is copied to the actual position and setpoint position (P 209 and/or 208) immediately without drive travel!



NOTE

- Increase the value specified in parameter POS Pos. window (P 429) if bit no. 12 is not set in M status word (P 121) after homing has been completed.
- Where the position of the tool carriage does not require a reversal at the home sensor (limit switch or home switch), phase 1 is done without, and the system accelerates to one eighth of the homing speed (phase 2).
- Parameter *Encoder offset* (P 435) can be used to shift the encoder zero angle to such an extent for internal computation that it moves outside the switch tolerances. At an encoder offset of 0 increments, the encoder zero angle corresponds to an actual encoder angle of 180°.
- If a limit switch is overshoot, the switch status must remain until the limit switch is switched again after a reversal.

Approaching the negative limit switch

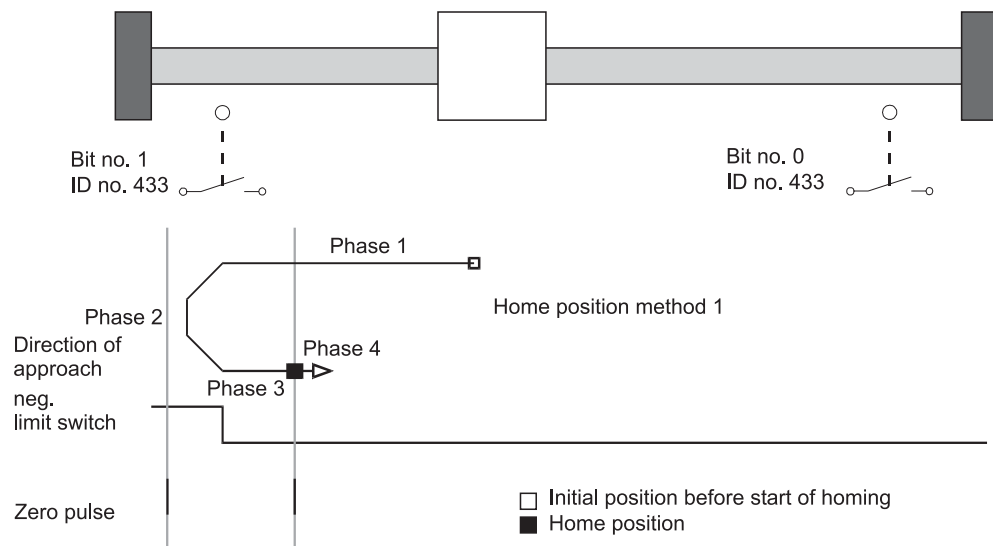
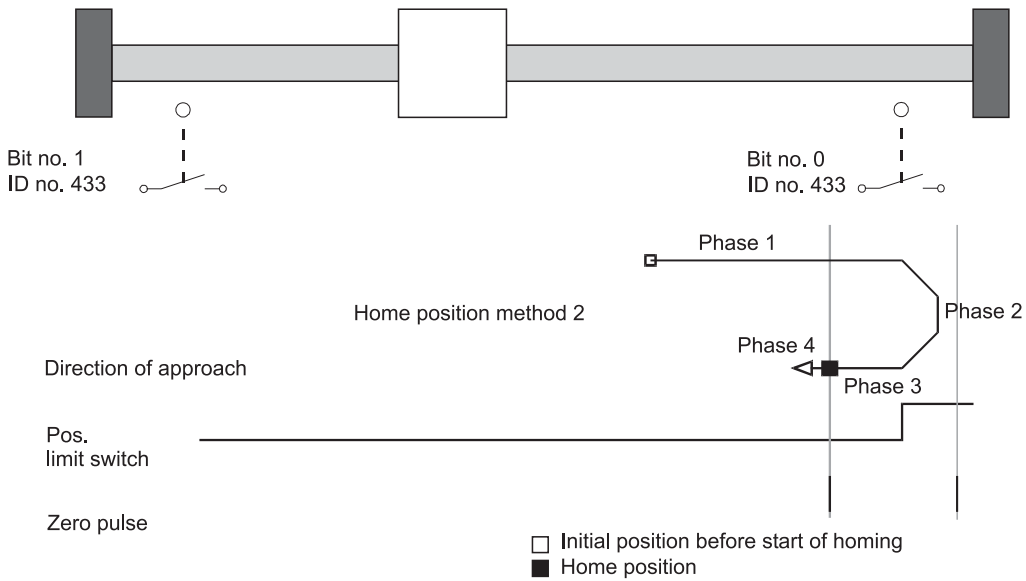

Figure 7: homing - negative limit switch

TMPG_008_rev01_int.cdr

Approaching the positive limit switch



TMPG_009_rev01_int.cdr

Figure 8: homing - positive limit switch

Approaching the positive home switch

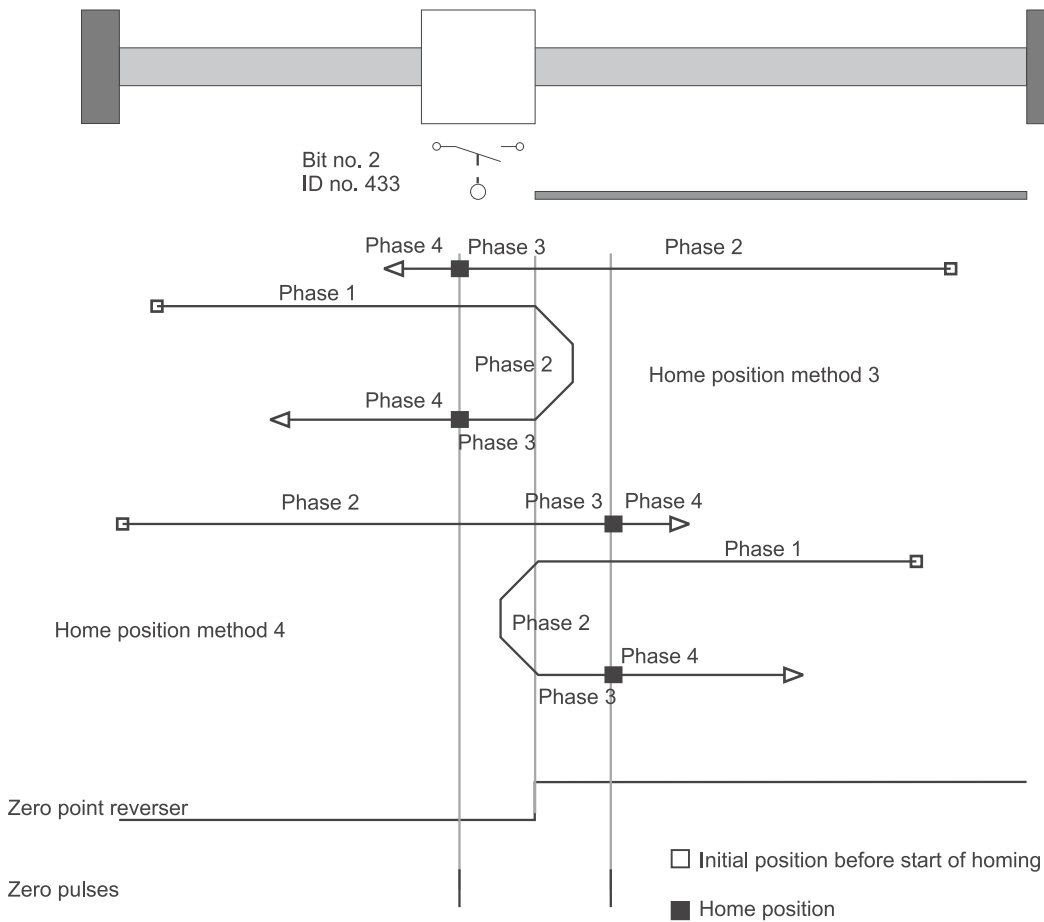

TMPG_010_rev01_int.cdr

Figure 9: homing - positive home switch

Approaching the negative home switch

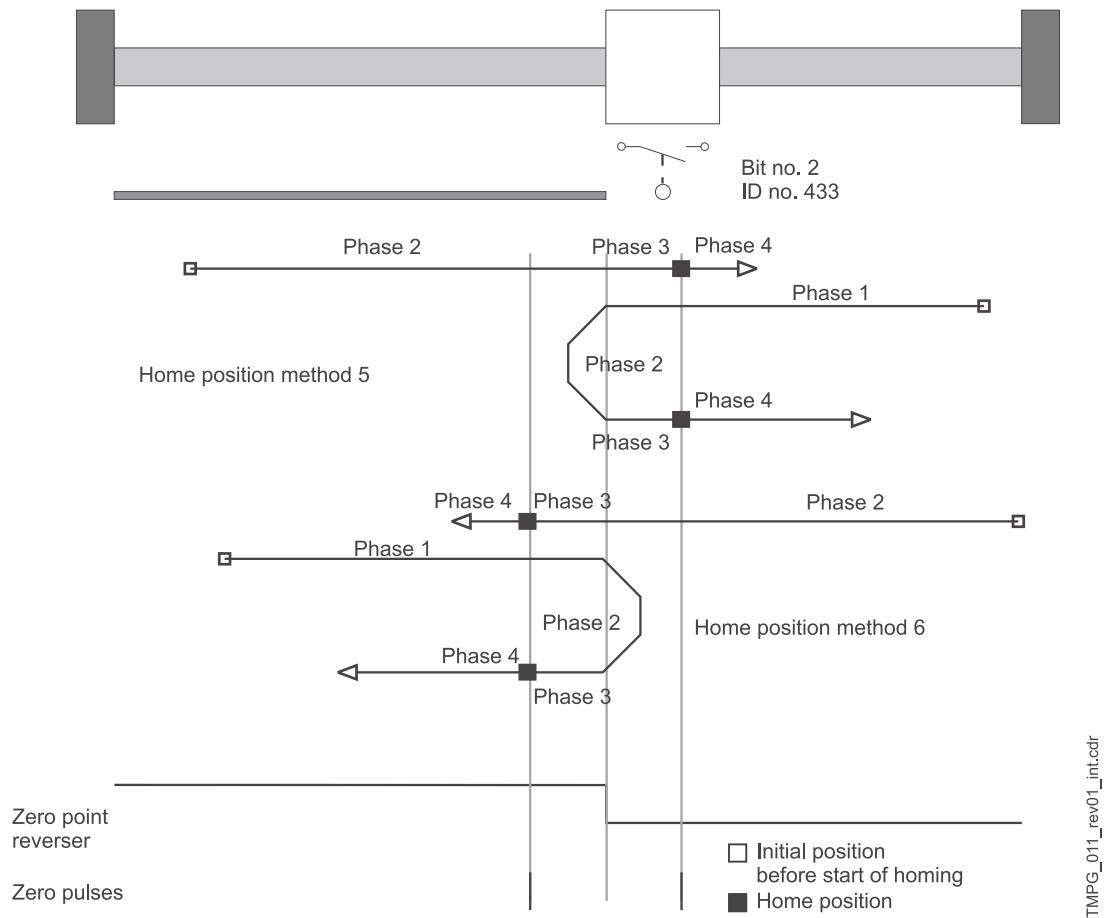

Figure 10: homing - negative home switch



NOTE

If a limit switch is overshoot, the switch status 'Activated' must remain until the limit switch is switched again after a reversal.

Method	Meaning
-6	Approaching the next encoder zero angle
-5	Approaching the positive limit switch
-4	Approaching the negative limit switch
-3	Set home position
-2	Approaching the encoder zero angle and/or zero pulse in CCW rotation
-1	Approaching the encoder zero angle and/or zero pulse in CW rotation
1	Approaching the negative limit switch with encoder zero angle and/or zero pulse homing
2	Approaching the positive limit switch with encoder zero angle and/or zero pulse homing
3	Approaching the positive home switch with encoder zero angle and/or zero pulse homing
4	Approaching the positive home switch with encoder zero angle and/or zero pulse homing
5	Approaching the negative home switch with encoder zero angle and/or zero pulse homing
6	Approaching the negative home switch with encoder zero angle and/or zero pulse homing

Encoder type	Encoder/s at input	Method no.	Parameter value (P 414)
Absolute encoder	1	-6	- 1 0 06
Absolute encoder	1	-2	- 1 0 02
Absolute encoder	1	-1	- 1 0 01
Absolute encoder	1	1	1 0 01
Absolute encoder	1	2	1 0 02
Absolute encoder	1	3	1 0 03
Absolute encoder	1	4	1 0 04
Absolute encoder	1	5	1 0 05
Absolute encoder	1	6	1 0 06
Absolute encoder	2	-6	- 2 0 06
Absolute encoder	2	-2	- 2 0 02
Absolute encoder	2	-1	- 2 0 01
Absolute encoder	2	1	2 0 01
Absolute encoder	2	2	2 0 02
Absolute encoder	2	3	2 0 03
Absolute encoder	2	4	2 0 04
Absolute encoder	2	5	2 0 05
Absolute encoder	2	6	2 0 06

Encoder type	Encoder/s at input	Method no.	Parameter value (P 414)
Incremental encoder	1	-2	- 1 1 02
Incremental encoder	1	-1	- 1 1 01
Incremental encoder	1	1	1 1 01
Incremental encoder	1	2	1 1 02
Incremental encoder	1	3	1 1 03
Incremental encoder	1	4	1 1 04
Incremental encoder	1	5	1 1 05
Incremental encoder	1	6	1 1 06
Incremental encoder	2	-2	- 2 1 02
Incremental encoder	2	-1	- 2 1 01
Incremental encoder	2	1	2 1 01
Incremental encoder	2	2	2 1 02
Incremental encoder	2	3	2 1 03
Incremental encoder	2	4	2 1 04
Incremental encoder	2	5	2 1 05
Incremental encoder	2	6	2 1 06
Incremental encoder	Not relevant	-5	-5
Not relevant	Not relevant	-4	-4
Not relevant	Not relevant	-3	-3



NOTE

If the encoder type entered is an incremental encoder, there must be a zero pulse. Only then must the homing modes provided for incremental encoders be set.

P 429

POS Pos. window

Once the drive reaches a window around the new target position, the bit 'Target position reached' is set in the status word. The positioning window is symmetrical around the target position, and its size is defined by the parameter 'Pos. window'.

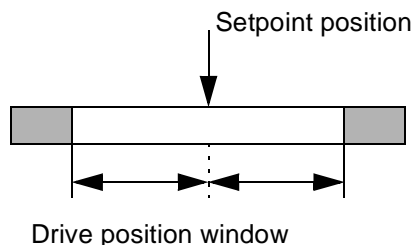

P 4 3 0 POS **Pos. window time**

To prevent setting of the bit 'Target position reached' on occasions where the positioning window is briefly exceeded, this parameter allows specification of a time for which the drive must be within the positioning window before the correct positioning is displayed.

P 4 3 1 POS **Backlash compensation**

Not yet implemented.

P 4 3 2 POS **Home position**

POS Home position is the value specifying the absolute position of the drive at the home position. This value must be set prior to homing. Once the drive has reached the home position after homing, this value is copied to setpoint position and actual position. The home position value must be within the permissible travel range, i.e., between the software limit switches (P 439 and 440).

P 4 3 3 POS **Status - switch**

The statuses of limit switches and home switch are mapped to this parameter by use of digital inputs.

If the bit representing the switch is = 1, the switch is activated

Bit no.	Description
0	Status - positive limit switch
1	Status - negative limit switch
2	Status - home switch
3	Reserved
4	Reserved
5	Reserved
6 - 15	Reserved

Examples for n. o. contact:

Programming the digital input 1 for positive end switch (method 2)

DI Input 1 Pxxx = 433	P 370
DI Bit-Selection 1 = 1 = 0001 _{hex}	P 371
DI LOW-Pattern 1 = 0 = 0000 _{hex}	P 372
DI HIGH-Pattern 1 = 1 = 0001 _{hex}	P 373

Programming the digital input 1 for negative end switch (method 1)

DI Input 1 Pxxx= 433	P 370
DI Bit-Selection 1 = 2 = 0002 _{hex}	P 371
DI LOW-Pattern 1 = 0 = 0000 _{hex}	P 372
DI HIGH-Pattern 1 = 2 = 0002 _{hex}	P 373

Programmierung des digitalen. Eingang 1 für Nullpunktumschalter (methods 3 to 6)

DI Input 1 Pxxx = 433	P 370
DI Bit-Selection 1 = 4 = 0004 _{hex}	P 371
DI LOW-Pattern 1 = 0 = 0000 _{hex}	P 372
DI HIGH-Pattern 1 = 4 = 0004 _{hex}	P 373

Examples for n. c. contact:

Positive end switch is n. c. contact --> Bit 4 used as additional identification bit

DI Input 1 Pxxx = 433	P 370
DI Bit-Selection 1 = 0011 _{hex}	P 371
DI LOW-Pattern 1 = 0010 _{hex}	P 372
DI HIGH-Pattern 1 = 0011 _{hex}	P 373

Negative end switch is n. c. contact --> Bit 5 used as additional identification bit

DI Input 1 Pxxx = 433	P 370
DI Bit-Selection 1 = 0022 _{hex}	P 371
DI LOW-Pattern 1 = 0020 _{hex}	P 372
DI HIGH-Pattern 1 = 0022 _{hex}	P 373



NOTE

Bit no. 0 and Bit no. 1 are evaluated as end switch conditions also in operation mode 'manual operation'!

P434 POS Mode - switch

This parameter can be used to set separately for each home sensor whether it is a normally-closed or a normally-open contact.

Bit no.	Description
0	Mode - positive limit switch
1	Mode - negative limit switch
2	Mode - home switch
3 - 15	Reserved

Bit = 0: Switch is a normally-open contact
 Bit = 1: Switch is a normally-closed contact

Digital input configuration (to be preferred to prevent wire breakage):

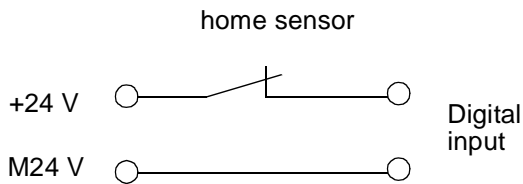

P 4 3 5 POS Encoder offset

During homing, the encoder offset is added to the current encoder angle and thus permits a zero angle signal shift. This allows the zero angle signal to be moved outside the switching tolerances of the home sensor.

P 4 3 6 POS Setpoint position

Here the setpoint position generated by the position control is displayed in UU (compare P208, setpoint position in increments).

P 4 3 7 POS Actual position

Here the current actual position is displayed in UU (compare P 209, actual position in increments).

P 438 POS Setpoint speed

This parameter displays the current setpoint speed input by the position control in l/ms.

P 439 POS SW limit switch 1

P 440 POS SW limit switch 2

These two parameters limit the permissible travel range in Target position input and Manual modes.

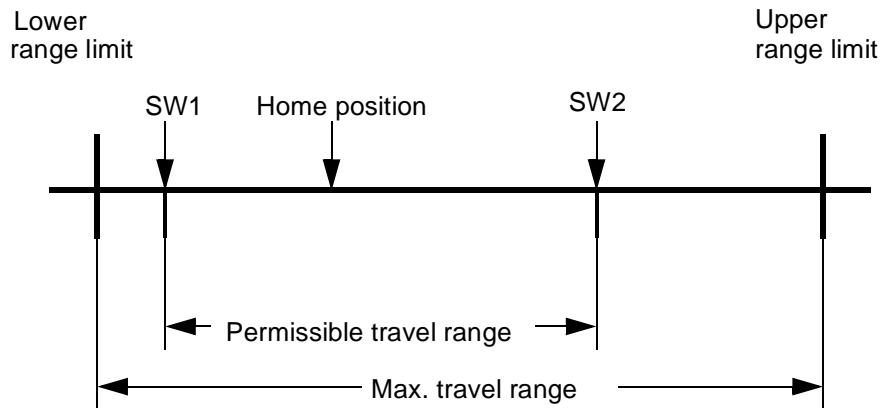

Lower range limit = 0000 0000_{hex}

Upper range limit = 0xFFFFFFFF • $\frac{\text{POS position scaling D (P 403)}}{\text{POS position scaling N (P 402)}}$

SW limit switch 1 contains the value for the permissible travel range start, SW limit switch 2 the value for the permissible travel range end.

The following prerequisites must be met to ensure correct functioning of the software limit switches:

- Bit no. 0 must be set in parameter *POS Mode* (P 406).
- Homing must be performed before the operating mode may be changed to Target position input and/or Manual. The SW limit switches are not active in homing mode!
- $0 < \text{SW limit switch 1} < \text{Home position} < \text{SW limit switch 2} < \text{Upper range limit}$.
- The maximum travel range must not be exceeded in any operating mode (except homing).

Software limit switch function:

- In target position input mode (P 122 = 1)
A check is made during target position input as to whether the new target position is outside the permissible travel range. If so, positioning is for the SW limit switch whose value would be overshoot. Furthermore, either bit no. 4 for SW limit switch 1 or bit no. 5 for SW limit switch 2 is set in *Module status* (P 400).
- If the value of a SW limit switch is changed after homing, the drive may be outside the new permissible travel range. The display in *Module status* and validity of the new value are updated during the next data transfer. Independent of the target input, positioning is for the associated SW limit switch if the input target position is also outside.

- In manual mode (P 122 = 5):
As soon as a software limit switch is reached, the drive slows down at the preset stop deceleration (P 408), and the associated bit in Module status is set. Travel is possible only in the opposite direction.
If the value of a SW limit switch is changed after homing, the drive may be outside the new permissible travel range. The display in the *Module status* is updated as soon as 'Jogging' is initiated.
Only after complete parameterisation and commissioning of the position control does the drive have two software limit switches in the Target position input and Manual modes, so that error-free operation does not require any mechanical limit switches in these operating modes. However, in order to be able to systematically reduce the possibly immense power inherent in the masses of a moving drive at any time, limit switches acting directly upon the power unit, i.e., the controller pulse enable, are indispensable.

P 442 POS Homing deceleration

The homing deceleration specifies the maximum drive deceleration in homing mode.

P 443 POS Final homing speed

The final homing speed defines the speed at which the drive is to approach the encoder zero angle and/or zero pulse. This parameter is effective only in homing mode.

P 444 POS Clip environment 1

When the actual position reaches a window around the target position, the bit 'Clip environment 1 reached' (bit no. 13 in parameter P 400, 'Module status') is set. This window is symmetrical around the target position, its size defined by parameter 'Clip environment 1'.

P 445 POS Clip environment 2

When the actual position reaches a window around the target position, the bit 'Clip environment 2 reached' (bit no. 14 in parameter P 400, 'Module status') is set. This window is symmetrical around the target position, its size defined by parameter 'Clip environment 2'.

3.2 Positioning record-specific parameters

Parameter *Current record number* (P 401) allows selection between 2 positioning records.

Parameter	Name	Range min. ... max.	Unit	Display only
P415	POS Target position 1	0 ... FFFF FFFF	UU	
P416	POS Target input 1	-2 ... +3		
P417	POS Positioning speed 1	1 ... 13200	l / ms	
P418	POS Final speed 1	0	l / ms	
P419	POS Pos. acceleration 1	0.25 ... 450.00	l / ms ²	
P420	POS Pos. deceleration 1	0.25 ... 450.00	l / ms ²	
P421	POS Dwell time 1	0 ... 65535	ms	
P422	POS Target position 2	0 ... FFFF FFFF	UU	
P423	POS Target input 2	-2 ... +3		
P424	POS Pos. speed 2	1 ... 13200	l / ms	
P425	POS Final speed 2	0	l / ms	
P426	POS Pos. acceleration 2	0.25 ... 450.00	l / ms ²	
P427	POS Pos. deceleration 2	0.25 ... 450.00	l / ms ²	
P428	POS Dwell time 2	0 ... 65535	ms	
P441	POS Rounding	0 ... 8191	ms	
P446	POS Bend of S-curve	1 ... 225	l / (16ms ³)	

P415 POS Target position 1

P422 POS Target position 2

The target position defines the position in UU at which the drive has reached final speed.

P 4 1 6 POS Target input 1

P 4 2 3 POS Target input 2

The 'target input' describes whether the target position has been input as an absolute or must be approached in relative terms

Value	Description
-2	Relative to actual position in the direction of smaller setpoint positions (flying)
-1	Relative to target position in the direction of smaller setpoint positions (normal)
0	Absolute – limited to maximum travel range
1	Relative to target position in the direction of larger setpoint positions (normal)
2	Relative to actual position in the direction of larger setpoint positions (flying)
3	Absolute in the direction of the shorter path to the target, i.e., the maximum travel range may be exceeded (condition: SW limit switch off !)

P 4 1 7 POS Pos. speed 1

P 4 2 4 POS Pos. speed 2

The positioning speed defines the maximum drive travel speed in positioning mode.

P 4 1 8 POS Final speed 1

P 4 2 5 POS Final speed 2

Not implemented yet.

P 4 1 9 POS Pos. acceleration 1

P 4 2 6 POS Pos. acceleration 2

This parameter sets the maximum drive acceleration in positioning mode.

P 4 2 0 POS Pos. deceleration 1

P 4 2 7 POS Pos. deceleration 2

Analog to the maximum acceleration, the positioning deceleration defines the maximum drive deceleration in positioning mode.

P 4 2 1 POS Dwell time 1

P 4 2 8 POS Dwell time 2

Not implemented yet.

P 441 POS Rounding

A PT₁ element has been implemented to round off the travel ramp edges. This parameter helps set the time constant of the PT₁ element.

The PT₁ element is valid for both position records if time optimised positioning (P 406 bit no. 1 = 0) is activated.

Rounding is deactivated at a setting of 0 ms.

P 446 POS Bend S-curve

This parameter corresponds with the maximum permitted acceleration change (maximum jerk). The lower the value, the lower the permitted jerk. This parameter is valid for both position records.

Example:

$$P\ 446 = 4\ \text{l}/(16\ \text{ms}^3)$$

$$P\ 419 = 10,00\ \text{l}/\text{ms}^2\ (\text{permitted acceleration})$$

After which time the value of P 419 is reached?

$$t = \frac{10,00}{\frac{4}{16}}\ \text{ms} = 40\ \text{ms}$$



NOTE

With time optimized positioning (P 406 bit no. 1 = 0):
An online change of values is valid immediatly.

With jerk limited positioning (P 406 bit no. 1 = 1)

An online change is possible too. This changes are not valid until the previous positioning is completed and the bit no. 7 "function completed" is set in P 400 POS Modul state. The values +2 and -2 are not suitable for jerk limited positioning.

TESTING THE 'POSITION CONTROL' MODES

This chapter describes the procedure to be applied for testing the Homing, Target position input and Manual operating modes.



NOTE

The device must have been parameterized before testing!

4.1 Testing the Homing mode

Parameterizing the relevant parameters

- Defining the scaling from external user units (UU) to internal increments (I)

POS Pos. scaling N e.g., 1 P 402

POS Pos. scaling D e.g., 1 P 403

When both parameters are set to 1, 1 increment = 1 user unit

- Defining the speed profile during homing

POS Homing speed e.g., 500 I/ms P 412

POS Final homing speed e.g., 10 I/ms P 443

POS Homing acceleration e.g., 5.00 I/ms² P 413

POS Homing deceleration e.g., 10.00 I/ms² P 442

The position value specifying the absolute position of the drive at the home position, must be entered in parameter *POS Home position* (P 432), e.g., 655360 UU.

4.1 Testing the Homing mode

The position of the home position and the direction of approach, i.e., the exact homing process, is set by using parameter *POS Homing mode* (P 414).

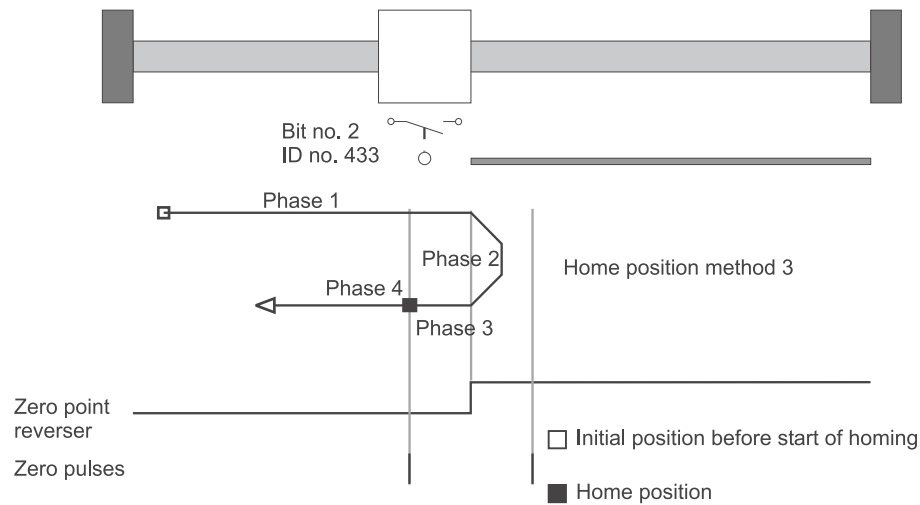

Figure 11: position of home position

Let us apply method 3 (approaching the positive home switch) in this example. This means that the home switch must always be inactive to the left of the zero point and always active to the right of the zero point. The home position is to the right of the zero point!

- The encoder is a resolver on encoder input 1.

POS Homing mode e.g., 1003 (P 414)

- Separate settings are possible in *POS Mode – switch* (P 434) to specify for each home sensor whether it is a normally-open or a normally-closed contact.
- Due to the set *POS Homing mode*, it is only the home switch in the example that is evaluated during homing. Assume the home switch to be a normally-closed contact.

POS Mode - switch: 0004_{hex} (bit no. 2 = 1)

- Bits 0 and 1 for the two limit switches are not relevant for this *POS Homing mode*.
- Parameter *POS Encoder offset* (P 435) is set to 0.

Program- ming the di- gital input for the home sensor

In the example, digital input 1 is now programmed to bit no. 2 of parameter *POS Status - switch* (P 433).

DI input 1 P _{xxx} = 433	P 370
DI bit selection 1 = 0004 _{hex}	P 371
DI LOW pattern 1 = 0000 _{hex}	P 372
DI HIGH pattern 1 = 0004 _{hex}	P 373



NOTE

It is also necessary to enter 0000_{hex}! Bit 0 must be set in parameter *DI state* (P 382) so that the digital input is switched through in terms of the software.

For testing purposes, it may be necessary to operate the home sensor manually. Check whether the associated bit is set in parameter *POS Status – switch* (P 433). Bit no. 2 must be set in the example when the home sensor is operated.

At parameterization make sure that the *POS Status - switch* (P 433) bit selected by use of the digital input corresponds to *POS Homing mode* (P 414) (refer to description of parameter P 433).

- Setting the operating mode** For the Homing mode, parameter *M setpoint operating mode* (P 122) must be set to 6.
- Enabling the drive manager** The following input sequence is required to enable the drive manager:
- *M control word* = 6 = 0006_{hex} (Command Stop) P 120
 - *M control word* = 15 = 000F_{hex} (Command Enable operation) P 120
- Setting external pulse enable** For any questions regarding the connector configuration, refer to the operating instructions of the particular controller.
- Starting homing** For this purpose, set bit no. 4 in parameter *M control word* (P 120).
- Homing is performed;
 - Homing is completed when bit no. 12 is set in *M status word* (P 121).
- Behaviour of the drive used in the example:
- Drive to the left of the zero point:
After the start signal, the drive moves towards the zero point at *POS Homing speed* (P 412), reverses at the zero point and stops at the home position (phases 1 to 4; see diagram ▶page 50◀).
 - Drive to the right of the zero point:
After the start signal, the drive moves towards the zero point at one eighth of the speed set in P 412, overshoots the zero point and stops at the home position (phases 2 to 4; see diagram ▶page 50◀).
- Troubleshooting checklist**
- o Drive does not start
 - Is the drive enabled and external pulse enable set?
 - Is *M actual operating mode* = 6 (P 123)?
 - Is position control on; bit no. 0 = 1 in *POS Module status* (P 400)?
 - Is start bit set in *M control word* (bit no. 4, P 120)?
 - Is bit no. 12 set in *M status word* (P 121)? If so, the drive might already have been near the home sensor. Maybe no movement was detected due to the short distance.
 - o Drive does not react to the home sensor signal
 - Is *M actual operating mode* = 6 (P 123)?
 - Is position control on; bit no. 0 = 1 in *POS Module status* (P 400)?
 - Check programming of the digital input (refer to ▶Programming the digital input for the home sensor◀ on page 50)

Start homing (continued)

- Drive homes, but bit no. 12 ('Home reached') is not set in M status word (P 121).
 - Enlarge POS Pos. window (P 429) until bit is set.
 - Reduce POS Pos. window time (P 430) until bit is set.

- Drive moves at a speed lower than specified in *POS Homing speed* (P 412).
 - Is *M actual operating mode* = 6 (P 123)?
 - Is position control on; bit no. 0 = 1 in *POS Module status* (P 400)?
 - Home sensor status is 'activated', so that the drive moves at only one eighth of the homing speed.
 - Check programming of the digital input should this drive movement be incorrect (refer to [►Programming the digital input for the home sensor◄](#) on page 50)
 - Check *POS Mode - switch* (P 434)!

- Drive moves into the wrong direction after start
 - Is *M actual operating mode* = 6 (P 123)?
 - Is position control on; bit no. 0 = 1 in *POS Module status* (P 400)?
 - Does the drive move at only one eighth of the homing speed?
Home sensor status 'activated'.
 - Check programming of the digital input should this drive movement be incorrect (refer to [►Programming the digital input for the home sensor◄](#) on page 50)
 - Check *POS Mode - switch* (P 434)!
 - Check set *POS Homing mode* (P 414)!

- Two home positions after repeated homing
 - Shift encoder zero angle by means of *POS Encoder offset* (P 435) by half a motor revolution, for example (enter 32768 increments)!

- No value input is accepted in parameters *POS Pos. scaling N* (P 402) or *POS Pos. scaling D* (P 403).
 - The condition $POS\ Pos.\ scaling\ N \geq POS\ Pos.\ scaling\ D$ must be met!

- No value input is accepted in parameters *POS Home position* (P 432), *POS SW limit switch 1* (P 439) or *POS SW limit switch 2* (P 440).
 - The following condition must be met:
 $POS\ SW\ limit\ switch\ 1 < POS\ Home\ position < POS\ SW\ limit\ switch\ 2$

4.2 Testing the Target position input mode

First perform a homing in any case (refer to ▶Testing the Homing mode◀ from page 49).

The subsequent example is subject to the same settings for parameters *POS Pos. scaling N* (P 402), *POS Pos. scaling D* (P 403) and *POS Home position* (P 432) as for ▶Testing the Homing mode◀ from page 49.

Parameterizing the relevant global parameters

Software limit switch monitoring may be switched on and/or off in parameter *POS Mode* (P406). To test the software limit switches, set *POS Mode* to 0001_{hex}. Then enter the values for the software limit switches.

The following condition must be observed:

$$POS\ SW\ limit\ switch\ 1 < POS\ Home\ position < POS\ SW\ limit\ switch\ 2$$

In the example *POS Home position* (P 432) was specified at 655360 UU. Scaling was defined at 1 UU = 1 increment (refer to ▶Testing the Homing mode◀ from page 49).

The permissible travel range is to be limited to five CCW motor revolutions and ten CW motor revolutions from the home position, for example.

- *POS SW limit switch 1* = (655360 - 5 * 65536) UU = 327680 UU (P 439)
- *POS SW limit switch 2* = (655360 + 10 * 65536) UU = 1310720 UU (P 440)

POS Current record numberscaling d (P401) selects the current positioning record, e.g., positioning record 1.

The three subsequent parameters are described in detail in ▶Global parameters◀ from page 29.

- *POS Pos. window* e.g., 10 UU (P 429)
- *POS Pos. window time* e.g., 10 ms (P 430)

Parameterizing the positioning record-specific parameters

The parameters of the first positioning record range from P 415 to 421, those of the second positioning record from P 422 to 428.

Example: After homing, the drive is exactly at the home position (= 655360 UU) and is now expected to move CW by six motor revolutions. In the example, we selected positioning record 1 whose parameters now need to be set accordingly.

- First option: Absolute positioning.

$$POS\ Target\ position\ 1 = (655360 + 6 * 65536)UU = 1048576\ UU \quad (P\ 415)$$

$$POS\ Target\ input\ 1 = 0 \quad (P\ 416)$$

- Second option: Relative positioning

$$POS\ Target\ position\ 1 = 6 * 65536\ UU = 393216\ UU \quad (P\ 415)$$

$$POS\ Target\ input\ 1 = 1 \quad (P\ 416)$$

Setting of the other positioning record parameters is independent of *POS Target input 1*.

The following three parameters define the speed profile during positioning, e.g.,

$$POS\ Pos.\ speed\ 1 = 500\ l/ms \quad P\ 417$$

$$POS\ Pos.\ acceleration\ 1 = 5.00\ l/ms^2 \quad P\ 419$$

$$POS\ Pos.\ deceleration\ 1 = 1.00\ l/ms^2 \quad P\ 420$$

Parameters *POS Final speed 1* (P 418) and *POS Dwell time 1* (P 421) are not implemented yet and do not need to be set!

4.2 Testing the Target position input mode

- Setting the operating mode** For this operating mode, set parameter *M setpoint operating mode* (P 122) to 1.
- Enabling the drive manager** The following input sequence is required to enable the drive manager:
- *M control word* = 6 = 0006_{hex} (Command Stop) (P 120)
 - *M control word* = 15 = 000F_{hex} (Command Enable operation) (P 120)
- Setting the external pulse enable** For any questions regarding the connector configuration, refer to the operating instructions of the particular controller (refer to ►Hardware requirements◄ from page 13).
- Starting target position input** Also set bit no. 11 in *M control word* (P 120).
The target position is reached when bit no. 10 is set in *M status word* (P 121). On completion of the positioning sequence in the example, parameter *Setpoint position* (P 436) reads 1048576 UUDI.
- Trouble-shooting checklist**
- Drive does not start
 - Is the drive enabled and external pulse enable set?
 - Is *M actual operating mode* = 1 (P 123)?
 - Is position control on; bit no. 0 = 1 in *POS Module state* (P 400)?
 - Is start bit set in *M control word* (bit no. 11, P 120)?
 - Parameters P 416 and/or 423 (*POS Target input 1* and/or *POS Target input 2*) are set to 0, i.e., positioning is to be absolute. The current POS setpoint position (P 436) is identical to *POS Target position 1* (P 415) and/or *POS Target position 2* (P 422).
 - Is software limit switch monitoring active; *POS Mode* = 1 (P 406)?
 - Are bits 4 or 5 set in *POS Module status* (P 400)?
If so, one of the two software limit switches was activated. For how to proceed from here in this case refer to the description of parameters *POS SW limit switch 1* and *POS SW limit switch 2* (P 439 and 440) in ►Global parameters◄ from page 29ff.
 - Drive travels a distance shorter than specified.
 - Is software limit switch monitoring active; *POS Mode* = 1 (P 406)?
 - Are bits 4 or 5 set in *POS Module status* (P 400)?
If so, one of the two software limit switches was activated. For how to proceed from here in this case, refer to the description of parameters *POS SW limit switch 1* and *POS SW limit switch 2* (P 439 and 440).
 - Drive is several increments off the computed target after positioning
 - Was positioning 'relative' (P 416 or 423 are not 0)?
 - Was the status 'Operation enabled' (pulses disabled) left after the last positioning or homing?
 - If so, this deviation was generated upon re-enabling the controller. The reason for this is the synchronisation of the setpoint position with the actual position (system deviation!) during enabling.
 - No value input is accepted in parameters *POS SW limit switch 1* (P 439) or *POS SW limit switch 2* (P 440).
 - Is the following condition met?
 $POS\ SW\ limit\ switch\ 1 < POS\ Home\ position < POS\ SW\ limit\ switch\ 2$

4.3 Testing the Manual mode

The following example is subject to the same settings for parameters *POS Pos. scaling N* (P 402), *POS Pos. scaling D* (P 403), *POS Mode* (P 406), *POS Home position* (P 432), *POS SW limit switch 1* (P 439) and *POS SW limit switch 2* (P 440) as in the previous chapters.

Parameterizing the relevant parameters

The speed profile during manual operation is defined in the following parameters:

<i>POS Jogging speed</i> e.g., 300 l/ms	P 409
<i>POS Jogging acceleration</i> e.g., 4.00 l/ms ²	P 410
<i>POS Jogging deceleration</i> e.g., 6.00 l/ms ²	P 411
<i>POS Stop deceleration</i> e.g., 20.00 l/ms ²	P 408

Setting the operating mode

For the Manual mode, parameter *M setpoint operating mode* (P 122) must be set to 5.

Programming the digital inputs

One digital input must be programmed to bit no. 11 (Jogging, forward) and another to bit no. 12 (Jogging, reverse) of *M control word* (P 120).

For example:

Digital input 2 for Jogging, forward (CW revolutions in this case)

DI P input 2 = 120	P 374
DI bit selection 2 = 0800 _{hex}	P 375
DI LOW pattern 2 = 0000 _{hex}	P 376
DI HIGH pattern 2 = 0800 _{hex}	P 377

Digital input 3 for Jogging, reverse (CCW revolutions in this case)

DI P input 3 = 120	P 378
DI bit selection 3 = 1000 _{hex}	P 379
DI LOW pattern 3 = 0000 _{hex}	P 380
DI HIGH pattern 3 = 1000 _{hex}	P 381



NOTE

It is also necessary to enter 0000_{hex} ! Bits 1 and 2 must be set in parameter *DI status* (P 382) so that digital inputs 2 and 3 can be switched through in terms of the software.

Enabling the drive manager

The following input sequence is required to enable the drive manager:

<i>M control word</i> = 6 = 0006 _{hex} (Command Stop)	P 120
<i>M control word</i> = 15 = 000F _{hex} (Command Enable operation)	P 120

Setting external pulse enable

For any questions regarding the connector configuration, refer to the operating instructions of the particular controller (refer to ►Hardware requirements◀ from page 13).

Start Jogging, forward

Digital input 2 (Jogging, forward) must set bit no. 11 in *M control word*.

- The drive receives increasing setpoint positions and turns CW as long as the bit remains set and software limit switch 2 is not reached.

4.3 Testing the Manual mode

Start Jogging, reverse

Digital input 3 (Jogging, reverse) must set bit no. 12 in *M control word*.

- The drive receives decreasing setpoint positions and turns CCW as long as the bit remains set and software limit switch 1 is not reached.



NOTE

The drive decelerates to 0 speed if bits nos. 11 and 12 are set in *M control word*!

Trouble-shooting checklist

- Drive does not start.
 - Is the drive enabled and external pulse enable set?
 - Is *M actual operating mode* = 5 (P 123)?
 - Is position control on; bit no. 0 = 1 in POS Module status (P 400)?
 - Is start bit set in *M control word* (bit no. 11 or 12) (P 120)?
 - Are bits 11 and 12 set in *M control word* (P 120)?
 - Is software limit switch monitoring active; *POS Mode* = 1 (P 406)?
 - Are bits 4 or 5 set in *POS Module status* (P 400)?
If so, one of the two software limit switches was activated. For how to proceed from here in this case refer to the description of parameters *POS SW limit switch 1* and *POS SW limit switch 2* (P 439 and 440).
- No value input is accepted in parameters *POS SW limit switch 1* (P 439) or *POS SW limit switch 2* (P 440).
 - Is the following condition met?
 $POS\ SW\ limit\ switch\ 1 < POS\ Home\ position < POS\ SW\ limit\ switch\ 2$
- Drive permits one direction of rotation only.
 - Is positive or negative hardware limit switch active?
Is bit no. 0 or 1 set in parameter P 433?
 - If so, check whether the drive is indeed within the range of influence of one of the two limit switches.

COMPARISON OF THE POSITIONING MODES

The different positioning modes are compared as follows.

Positioning data for the example:

- Movement = 5 motor revolutions = 50000_{hex}
- Max. speed = 1000 l/ms^2
- Max. acceleration = 20 l/ms^2
- Max. deceleration = 20 l/ms^2

5.1 Profiles of positioning modes

P 406 bit no. 1 = 0.

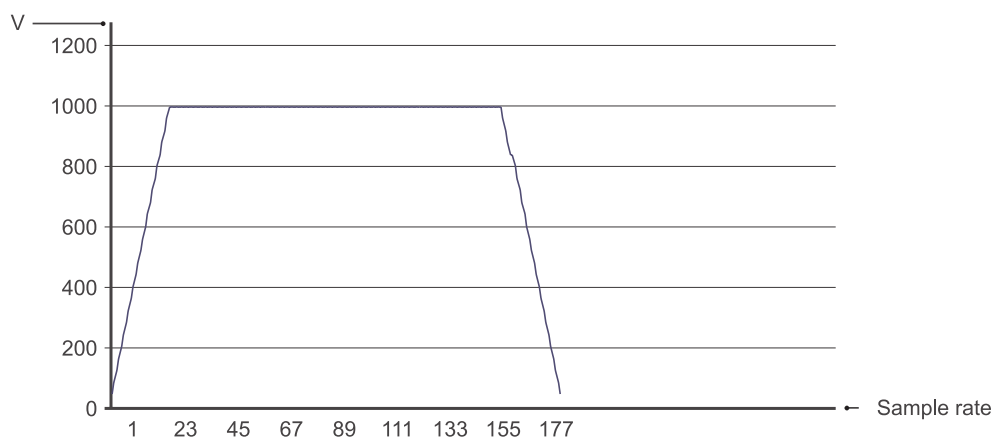
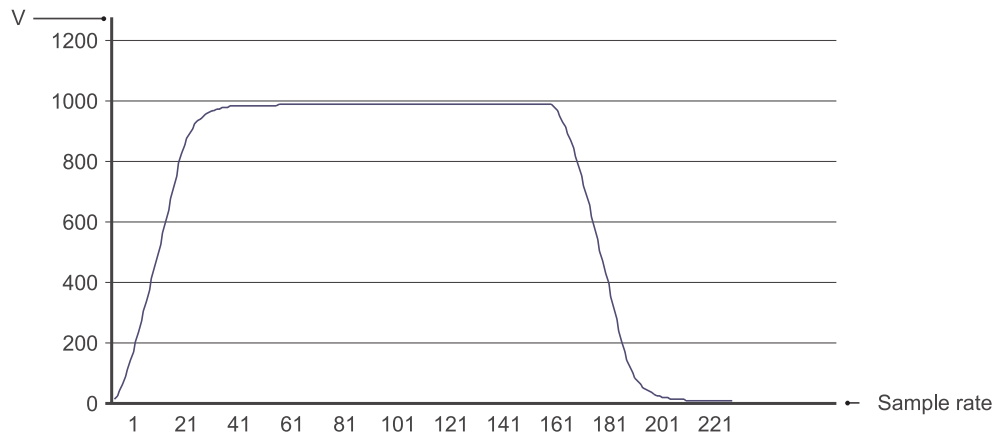

Figure 12: Time optimized positioning (trapezoid profile of speed)

TMPG_013_rev01_int.cdr

P 406 bit no. 1 = 0.



TMPG_014_rev01_int.cdr

Figure 13: Time optimized positioning with rounding = 10 ms (PT1)

P 406 bit no. 1 = 1.

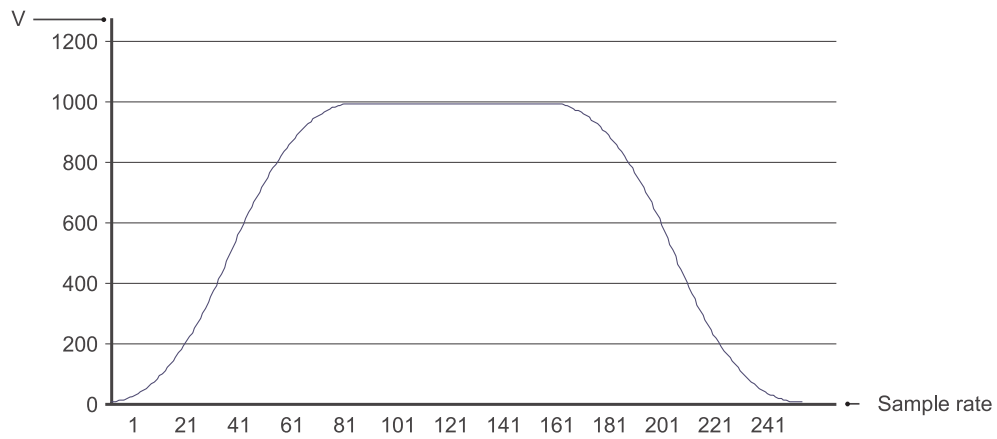

TMPG_015_rev01_int.cdr

Figure 14: Jerk limited positioning (S-curve profile of speed) with bend = 2

P 406 bit no. 1 = 1.

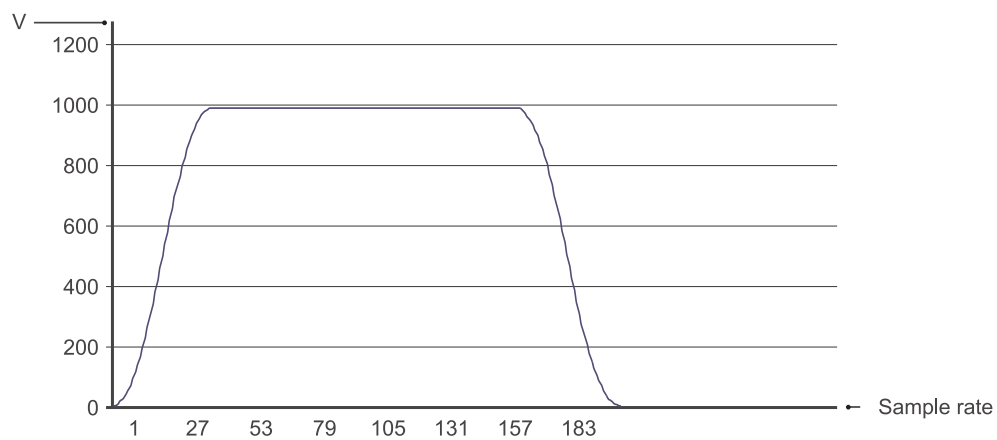

TMPG_016_rev01_int.cdr

Figure 15: Jerk limited positioning (S-curve profile of speed) with bend = 10

5.2 Comparison

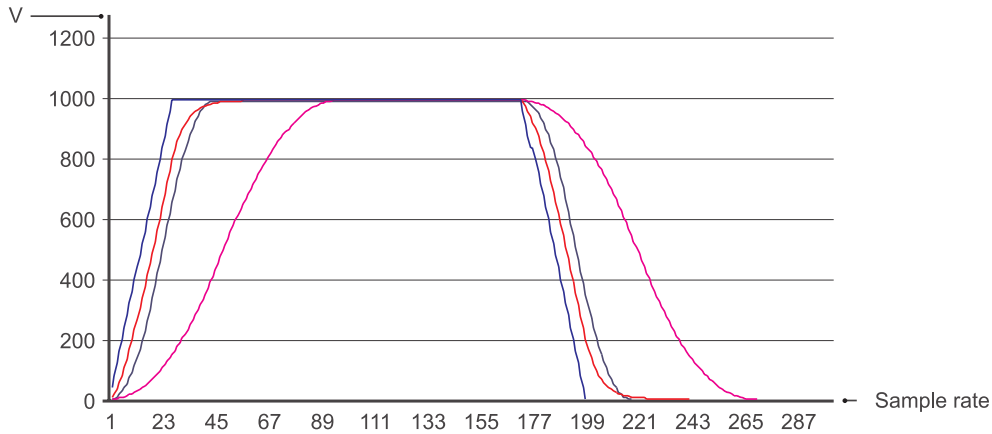

TMPG_017_rev01_int.cdr

Figure 16: Comparison of curves (trapezoid profile and S-curve profile)

	Time optimized	Time optimized with rounding	Jerk limited (S-curve)
Time [sampling steps]	188	230	207 or 257
Starting behaviour	-	o	+
Entering target	-	+	+
Acceleration profile	rectangular	PT ₁ behaviour	trapezoidal
Max. jerk (Δa)	nonterminated	indirectly setable by using time constant	setable by use of rounding

EXAMPLE OF A POSITION CONTROL APPLICATION

6.1 Examples

The example below describes the procedure for parameterizing the position control on the basis of a spindle control.

The setup is as shown. The task is to position the carriages contact on the spindles within the range between the two *software limit switches* SW1 and SW2, while the position, at the same carriage position, must be identical for both drive units. The following data apply to both drive units.

Motor:

$n_n = 3000 \text{ rpm}$

1 motor revolution (65536 increments)

$\Delta E n_n = 3000 \text{ rpm} * 65536 \text{ increments} / (60 * 1000 \text{ ms/min})$

$\Delta E n_n = 3000 \text{ rpm} * 1,092 \text{ increments} * \text{ms/min}$

$\Delta E n_n = 3276 \text{ increments/ms}$

Stepdown:

1 : 2.5

Spindle pitch:

6.4 mm

Permissible travel range:

3000 mm (distance SW1 - SW2)

Encoder:

Incremental encoder at encoder input 2

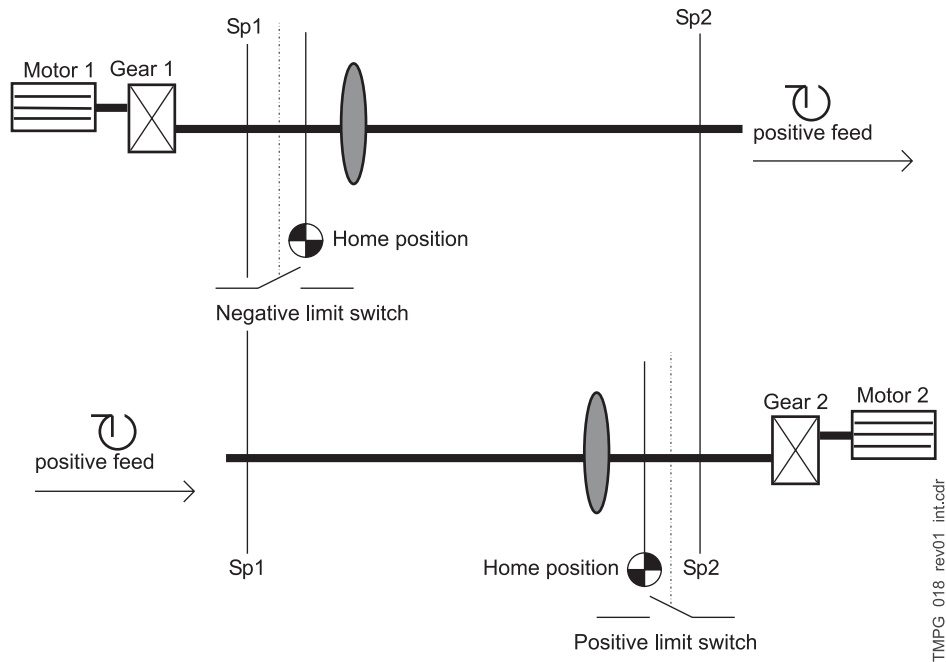

Figure 17: Example positioning

The applicable scaling is as follows: $1 \text{ UU} \hat{=} 1/100 \text{ mm}$

Computing the scaling parameters: $1 \text{ motor revolution} \hat{=} 65536 \text{ I}$

$1 \text{ motor revolution} \hat{=} 2.5 * 6.4 \text{ mm} = 16 \text{ mm}$

$1/100 \text{ mm} \hat{=} 65536 \text{ I} * 1/100 \text{ mm} / 16 \text{ mm}$

$1/100 \text{ mm} \hat{=} 1 \text{ UU} \hat{=} 4096 \text{ I}$

$\text{Æ POS Pos. scaling } N = 4096$ (P 402)

$\text{Æ POS Pos. scaling } D = 100$ (P 403)

Parameter *G2 mode* (P 241, bit no. 1) offers the option of a reversal through setpoint symbol reversal. Therefore the following parameterization of *G2 mode* allows both drive units to be treated identically in terms of target position input after homing.

G2 mode = 0020_{hex} for drive unit 1 (P 241)

= 0022_{hex} for drive unit 2

Quick stop The quick stop is to be triggered by using a digital input.

Programming digital input 1 to *M control word* (P 120):

DI input 1 Pxxx = 120 (P 370)

DI bit selection 1 = 4 = 8004_{hex} (P 371)

DI LOW pattern 1 = $32768 = 8000_{\text{hex}}$ (P 372)

DI HIGH pattern 1 = $32772 = 8004_{\text{hex}}$ (P 373)



NOTE

Bit no. 15 in *M control word* is the so-called write protection bit. Setting this bit prevents the *M control word* from being overwritten by another communication source before it was processed. The write protection bit is reset automatically.

Parameter settings for homing:

M control word = 15 = 000F_{hex} = Operation enabled (P 120)
M setpoint operating mode = 6 (P 122)
POS Homing speed e.g., 500 l/ms (P 412)
POS Final homing speed e.g., 10 l/ms (P 443)
POS Homing acceleration e.g., 5.00 l/ms (P 413)
 Æ results in an acceleration time of 100 ms

POS Homing deceleration (P 442) e.g., 10.00 l/ms (P 413)
 Æ results in a deceleration time of 50 ms

Defining *POS Homing mode* (P 414):

Drive 1: Travel towards negative limit switch ? *POS Homing mode* = 2101

POS Mode - switch = 0 = 0000_{hex} (P 434), since limit switch is a normally-open contact
 (*POS Mode - switch* = 2 = 0002_{hex}, if limit switch were a normally-closed contact)

Programming digital input 2 for limit switch to

POS Status - switch (P 433):

DI input 2 Pxxx = 433 (P 374)
DI bit selection 2 = 2 = 0022_{hex} (P 375)
DI LOW pattern 2 = 0 = 0020_{hex} (P 376)
DI HIGH pattern 2 = 2 = 0022_{hex} (P 377)

Drive 2: Travel towards positive limit switch ? *POS Homing mode* = 2102

POS Mode - switch = 0 = 0000_{hex} (P 434), since limit switch is a normally-open contact
 (*POS Mode - switch* = 1 = 0001_{hex}, if limit switch were a normally-closed contact)

Programming digital input 2 for limit switch to *POS Mode - switch* (P 433):

DI input 2 Pxxx = 433 (P 374)
DI bit selection 2 = 1 = 0011_{hex} (P 375)
DI LOW pattern 2 = 0 = 0010_{hex} (P 376)
DI HIGH pattern 2 = 1 = 0011_{hex} (P 377)

Once the home positions have been determined, their position data must be defined. This application also requires measuring of the distance between the home positions to reach the same carriage position at the same setpoint position.

E.g., distance between home positions 2800 mm (280 000 UU)

? Drive 1: *POS Home position* = 110 000 UU (P 432)

? Drive 2: *POS Home position* = 390 000 UU (P 432)

To start homing: Also set *M control word* bit no. 4 Æ 31 = 001F_{hex}

Homing is completed when bit no. 12 is also set in *M status word* Æ 1037_{hex}



NOTE

Should there be two home positions at one drive after repeated homing, shift the home position by means of *Encoder offset* (P 435)!

Parameterizing the **software limit switches**:

Permissible travel range 3000 mm (300 000 UU)

? POS SW limit switch 1 = 100 000 UU (P 439)

? POS SW limit switch 2 = 400 000 UU (P 440)

Settings for **Manual mode**:

M control word = 15 = 000F_{hex} = Operation enabled (P 120)

M setpoint operating mode = 5 (P 122)

POS Jogging speed e.g., 200 l/ms (P 409)

POS Jogging acceleration e.g., 5.00 l/ms² (P 410)

Æ results in an acceleration time of 40 ms

POS Jogging deceleration e.g., 10.00 l/ms² (P 411)

Æ results in a deceleration time of 20 ms

To start Jogging, forward: Also set bit no. 11 in *M control word* ? 2063 = 080F_{hex}

To start Jogging, reverse: Also set bit no. 12 in *M control word* ? 4111 = 100F_{hex}

Parameterizing the **target position input**:

M control word = 15 = 000F_{hex} = Operation enabled (P 120)

M setpoint operating mode = 1 (P 122)

POS Pos. window e.g., 4 UU (P 429)

POS Pos. window time e.g., 10 ms (P 430)

POS Current record number e.g., 1 (P 401)

Sample parameterization for a **position control record**:

Drive 1 is at a current setpoint position of 110000 UU after homing, for example, and is to be positioned to 250000 UU by means of absolute positioning at the shortest possible travel time.

Æ *POS Target position 1* = 250000 UU (P 415)

Æ *POS Target input 1* = 0 (absolute pos.) (P 416)

Æ *POS Pos. speed. 1* = 3276 l/ms (3000 rpm) (P 417)

The motor permits the following maximum acceleration values:

Æ *POS Pos. acceleration 1* = 20.00 l/ms² (P 419)

Æ *POS Pos. deceleration 1* = 24.00 l/ms² (P 420)

To start positioning: Also set *M control word* bit no. 11 ? 2063 = 080F_{hex}

Positioning is completed when bit no. 7 is set in *POS Module status* ? 0081_{hex}

The target position has been reached when bit no. 10 is set in *M status word* ? 0437_{hex}

- Acceleration time t_B in ms
- Deceleration time t_V in ms
- Time during which travel is at max. speed - t_K in ms
- Overall travel time t_{overall} in ms
- Max. speed v in I/ms
- Overall distance s in UU
- Distance travelled in acceleration phase s_B in UU
- Distance travelled in deceleration phase s_V in UU
- Distance travelled at max. speed s_K in UU
- Acceleration a_B in I/ms²
- Deceleration a_V in I/ms²

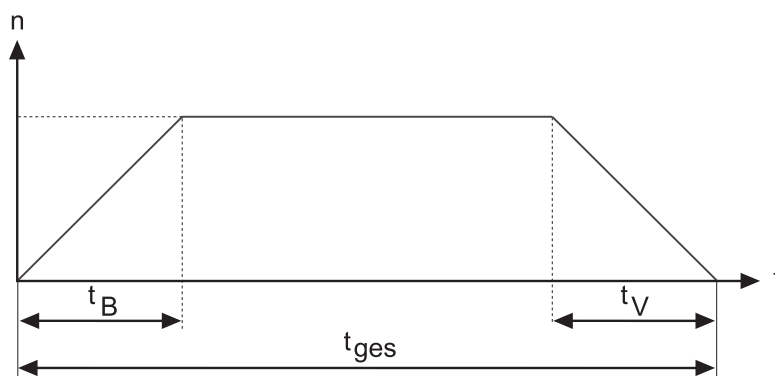

Figure 18: speed time diagram (positioning)

TMPG_019_rev01_int.cdr

Speed/time profile:

$$t_B = \frac{v}{a_B} = \frac{3276 \frac{\text{I}}{\text{ms}}}{20 \frac{\text{I}}{\text{ms}^2}} \approx 164 \text{ ms} \qquad t_V = \frac{v}{a_V} = \frac{3276 \frac{\text{I}}{\text{ms}}}{24 \frac{\text{I}}{\text{ms}^2}} \approx 137 \text{ ms}$$

$$s = 250\,000 \text{ UU} - 110\,500 \text{ UU} = 139\,500 \text{ UU}$$

$$s_B = 0,5 \cdot a_B \cdot t_B^2 = 0,5 \cdot 20 \cdot \frac{\text{I}}{\text{ms}^2} \cdot (164 \text{ ms})^2 = 268960 \text{ I} = 268960 \text{ I} \cdot \frac{100 \text{ UU}}{4096 \text{ I}} \approx 6566 \text{ UU}$$

$$s_V = 0,5 \cdot a_V \cdot t_V^2 = 0,5 \cdot 24 \cdot \frac{\text{I}}{\text{ms}^2} \cdot (137 \text{ ms})^2 = 225228 \text{ I} = 225228 \text{ I} \cdot \frac{100 \text{ UU}}{4096 \text{ I}} \approx 5498 \text{ UU}$$

$$s_K = s - s_V - s_B = (139500 - 5498 - 6566) \text{ UU} \qquad s_K \approx 127436 \text{ UU}$$

$$t_K = \frac{s_K}{v} = \frac{127436 \text{ UU}}{3276 \frac{\text{I}}{\text{ms}}} \cdot \frac{4096 \text{ I}}{100 \text{ UU}} \approx 1594 \text{ ms}$$

$$t_{\text{ges}} = t_B + t_V + t_K = (164 + 137 + 1594) \text{ ms} = 1895 \text{ ms}$$

TMPG_020_rev01_int.cdr

The above computations apply for continuous setpoint position input.

However, the accuracy of the results is sufficiently identical to those for discrete setpoint input.



SPINDLE POSITIONING (M19)



NOTE

Available from V-Controller SW-Version 4.01 or higher.

Function

When P 122 M desired operation mode is set to -6 (spindle positioning), the controller is switched into the internal position control and decelerates the drive to P 309 SP Pos. speed. After the SP Pos. speed is reached, the drive moves depending on P 307 SP Mode to the angle value which is set in P 308 SP Pos. angle.

When the position set value is equal to P 308 SP Pos. angle and the position actual value is the required deviation time inside the deviation limit (P 212 P deviation limit static, P 214 P deviation time), the drive sets in P 306 SP state the bit "in position". This message is equal to the bit no. 10 in P 121 M state word.

As long the operation mode "spindle positioning" is active, the drive is in position control und moves to every new angle, which is set in P 308 SP pos. angle.

The online-switching during $N \neq 0$ into the operation mode spindle positioning without a jerk is possible from following operation modes:

- Synchronisation control P 122 = -5
- Position control P 122 = -4
- Speed control P 122 = -3
- Target position specification P 122 = 1
- Speed specification P 122 = 2
- Manual mode P 122 = 5
- Reference run mode P 122 = 6

It is allowed to switch online from the operation mode current control (P 122 = -2) into spindle positioning, but the speed has to be zero!

7.1 List of parameters

7.1 List of parameters

Parameter	Name	Range min. ... max.	Unit	Display only
P 306	SP State	0000 ... FFFF		×
P 307	SP Mode	0000 ... FFFF		
P 308	SP Position angle	0000 ... FFFF	l	
P 309	SP Position speed	0.01 ... 10.00	%	
P 310	SP Deceleration	0.25 ... 450.00	l/ms ²	

Spindle Positioning (SP):

The interface includes the following controls:

- set mode:** A numeric input field with a value of 3.
- mode:** A dropdown menu currently showing "towards higher position set value".
- deceleration:** A numeric input field with a value of 5.00 and unit l/ms².
- pos. speed:** A numeric input field with a value of 1.00 and unit %.
- pos angle:** A numeric input field with a value of 0000 and unit l.
- pos.dev.monitor:** A button for monitoring position deviation.
- in position:** A radio button indicator.

P 306 SP State

- This parameter shows the actual status of the function module.

Bit no.	Meaning
0 ... 2	000: STOP 001: RUN 101: INIT
3	reserved
4 ... 6	State of current positioning: 000: switched off 001: initiation 010: accelerate to SP Pos. speed 011: decelerate to SP Pos. speed 100: SP Pos. speed reached 101: move to SP Pos angle 110: setpoint = SP Pos. angle
7 ... 11	reserved
12	In position
13 ... 15	reserved

P 307 SP Mode

When in P 225 EM state the bit no. 10 is set (N = 0 message, motor leading encoder), you can choose in this parameter the rotation direction to reached the SP Pos. angle (P 308). If N ≠ 0, the actual rotation direction will unchanged independent of the SP Mode.

Bit no.	Meaning
0 ... 1	00: towards higher position set value 01: towards lower position set value 10: shortest way to SP pos. angle 11: reserved
2 ... 15	reserved

This parameter can only be changed when the controller state isn't "operation enabled"!

P 308 SP Position angle

This is the absolute destination angle position related to the reference position. The 64-bit destination position is composed of following parts:

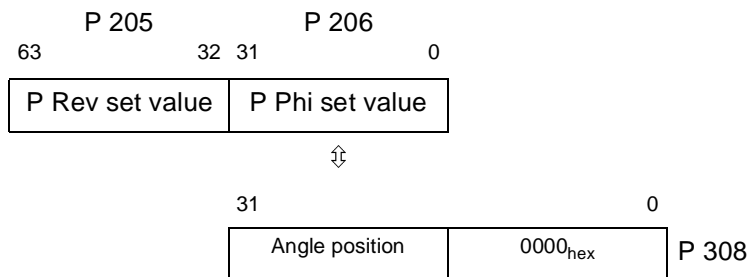

7.2 Diagrams spindle positioning

P 309 SP Position speed

When the operation mode spindle positioning is active, the drive decelerates to SP pos. speed or stays in the current set speed.

If this is done during $N = 0$, the drive accelerates maximally to SP Pos. speed.

This parameter can only be changed when the controller state isn't "operation enabled"!

P 310 SP Deceleration

This parameter is for setting the maximum deceleration in the operation mode spindle positioning.

The value is also valid for the acceleration from $N = 0$ to SP Pos. speed.

This parameter can only be changed when the controller state isn't "operation enabled"!

7.2 Diagrams spindle positioning

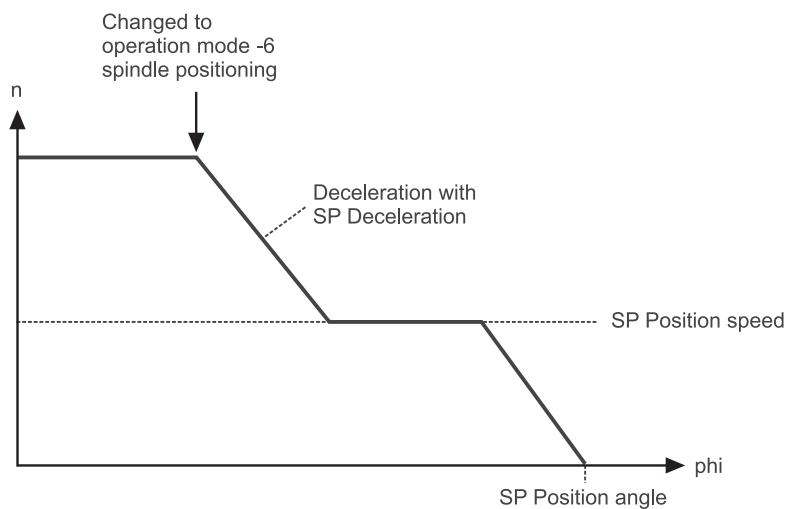

Figure 19: Speed actual value > SP Position speed

TMPG_021_rev01_int.cdr

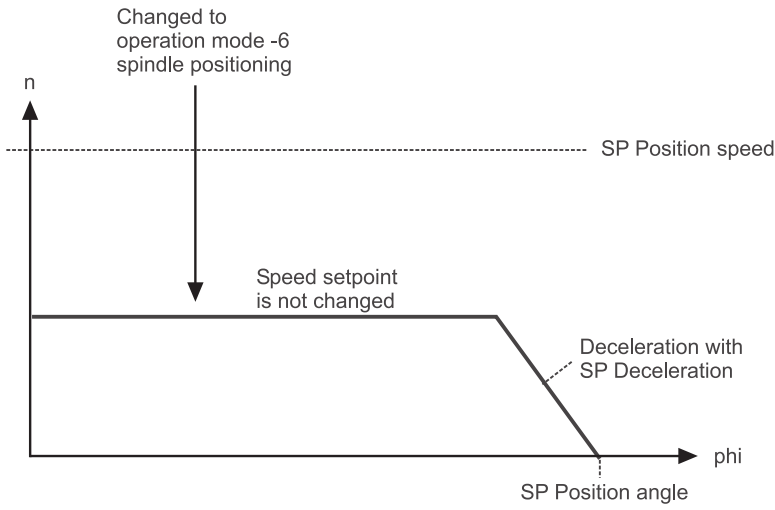

Figure 20: Speed actual value > SP Position speed

TMPG_022_rev01_int.cdr

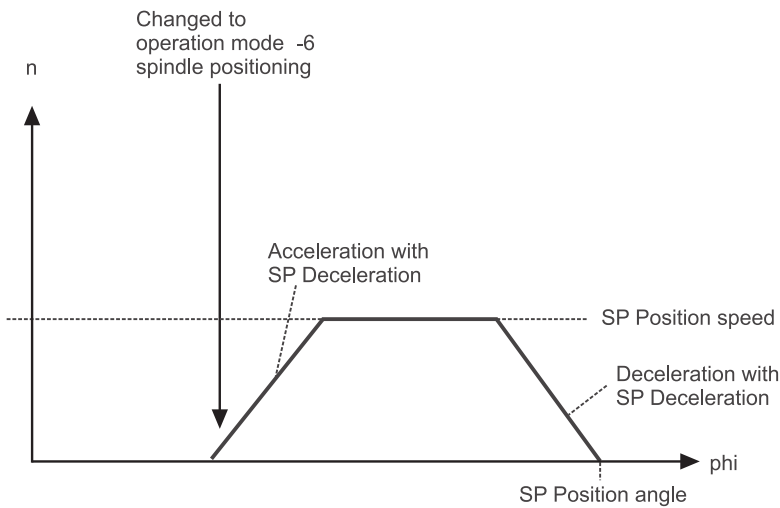

Figure 21: Speed actual value = 0 (N-message of motor leading encoder set)

TMPG_023_rev01_int.cdr

COMMISSIONING THE SYNCHRONIZATION CONTROL

These commissioning instructions are designed to assist you in parameterizing the *synchronization control* of the V-controller with the help of WinBASS in a way allowing standalone operation by use of switch signals. Rerouting to the machine with triggering effected through relay contacts or digital outputs (higher-level control) is possible.

8.1 Functional description

A standard feature of the operating system, the *synchronization control* of the V-controller moves a slave axis in perfect angular synchronism with a master axis.

The actual position of the real master axis may be detected with one of the following encoder systems:

- **Incremental encoders:** Rectangular-wave incremental encoder, sine-wave incremental encoder

or

- **absolute encoders:** Single-turn encoder (resolver, SCS70, SRS50), multi-turn encoder (SCM70, SRM50).

The master axis for the slave may also be a virtual master.

There are three different synchronization modes:

Speed synchronization/relative angle synchronization

When the drive controller is enabled in 'Synchronization' mode or switched to this operating mode online, the system uses the actual positions of the encoder evaluation of master axis and position controller, current at that point in time, as the basis for computation. This means that the rotating shaft (master axis) and the motor (slave axis) have a firm, yet undefined angle relationship with each other from this point onwards.

When the controller is disabled or the operating mode is changed, any existing angle relationship between master and slave axes will be lost.

Absolute angle synchronization

After controller enable and/or online switchover into this operating mode, the zero pulse of the slave axis is synchronized with the zero pulse of the master axis. This is possible only while the master axis is rotating and both master and slave axes are designed with incremental encoders with an identical number of increments (this operating mode is therefore not possible with resolvers).

8.2 Structure

Synchronous setpoint input Synchronous setpoint input specifies the setpoint positions directly (using field bus, for example).

Electronic gear unit The electronic gear unit expands the functionality of the *synchronization control* by the adjustability of the ratio between slave and master axes. The ratio i is input from 32767 : 1 to 1 : 32767 as a quotient from two natural numbers and may be changed online (during operation).

The *synchronization control* is controlled either by using

- the digital inputs of the V-controller,
- a field bus interface or
- by means of an Ω mega-DriveLine.

Parameterization and how to start the individual functions of the *synchronization control* is detailed below.

8.2 Structure

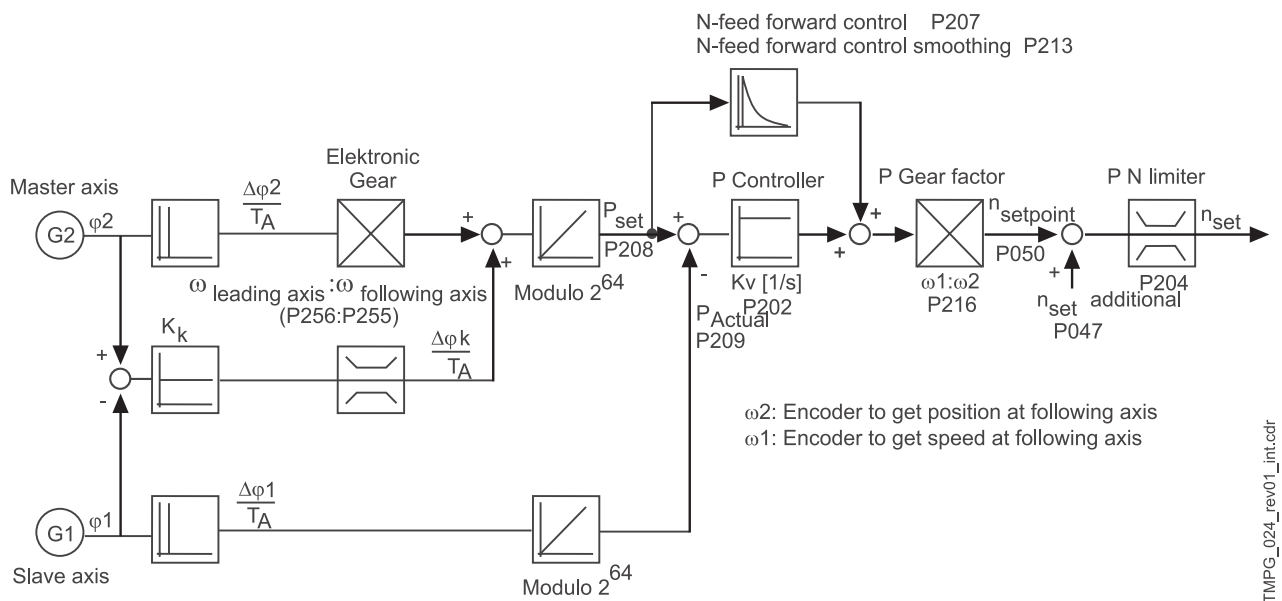

Figure 22: structure of synchronization control

8.3 Hardware requirements

Commissioning the synchronization control with one drive unit requires a specific mechanical setup.

The diagrams below show the mechanical and electrical setups that formed the basis for the commissioning example.



DANGER

Observe the safety regulations, outlined in the documentation for the individual components, throughout all commissioning activities.

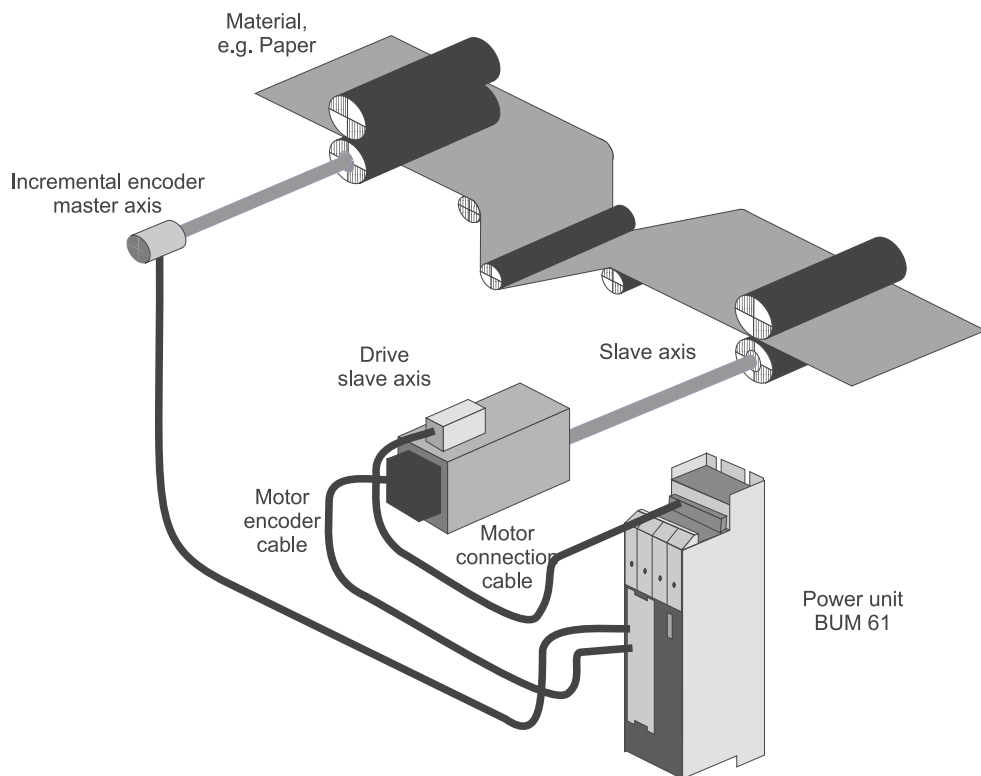

Figure 23: Mechanical setup - overview

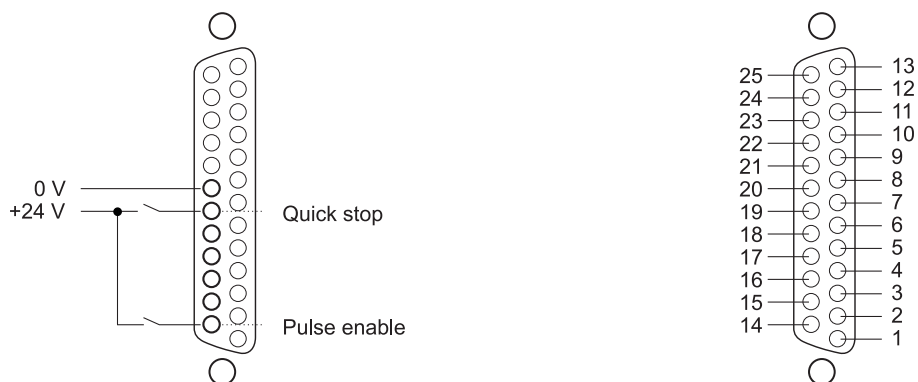

Figure 24: Diagram of the electrical terminating resistor connector X26

Prerequisite for operation of the *synchronization control* is a completed initial commissioning of the drive unit (refer initial commissioning V-controller with WinBASS). During initial commissioning, make sure that the drive can rotate freely and that there are no mechanical obstructions.

8.4 Commissioning

Once your drive unit has been successfully commissioned for the first time, you may now start commissioning the *synchronization control*.

All parameter settings that will not be changed during the subsequent commissioning process, have already been set to functional defaults by the interactive commissioning. Should you wish to make any changes to these settings, refer to ▶Parameters - Synchronization control◀ from page 83 for an explanation of the parameter and its setting options.

8.4 Commissioning

Now that you have connected and checked your components in accordance with the switching diagrams ▶Hardware requirements◀ from page 74 , apply the supply voltages and start the controller operating program WinBASS to display the WinBASS start window.

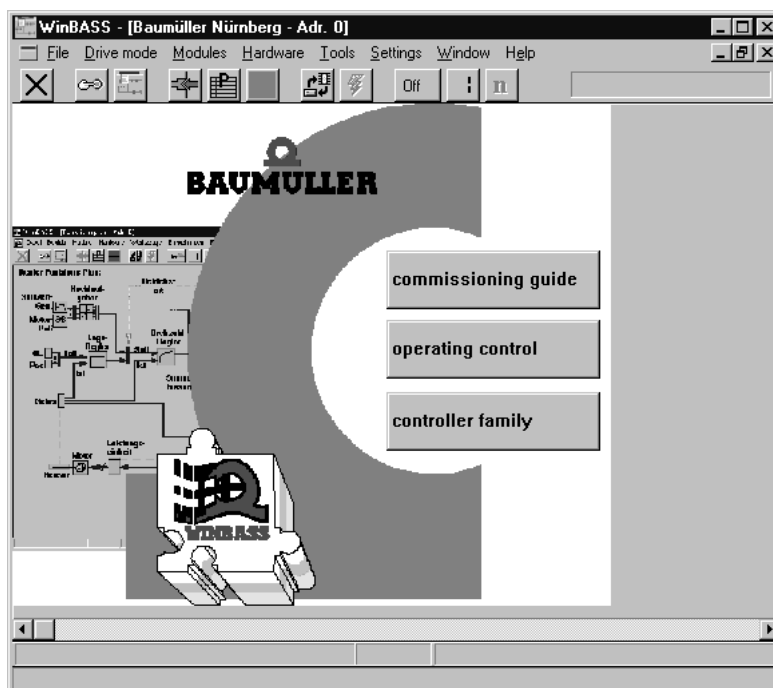

Click the button Off in the menu bar to establish communication with the controller. Once communication has been successfully established, the button changes its display from **Off** to **On** and ongoing communication is indicated by a rotating green segment.

Now click the button **Controller operation** in the screen centre to display the controller functional diagram.

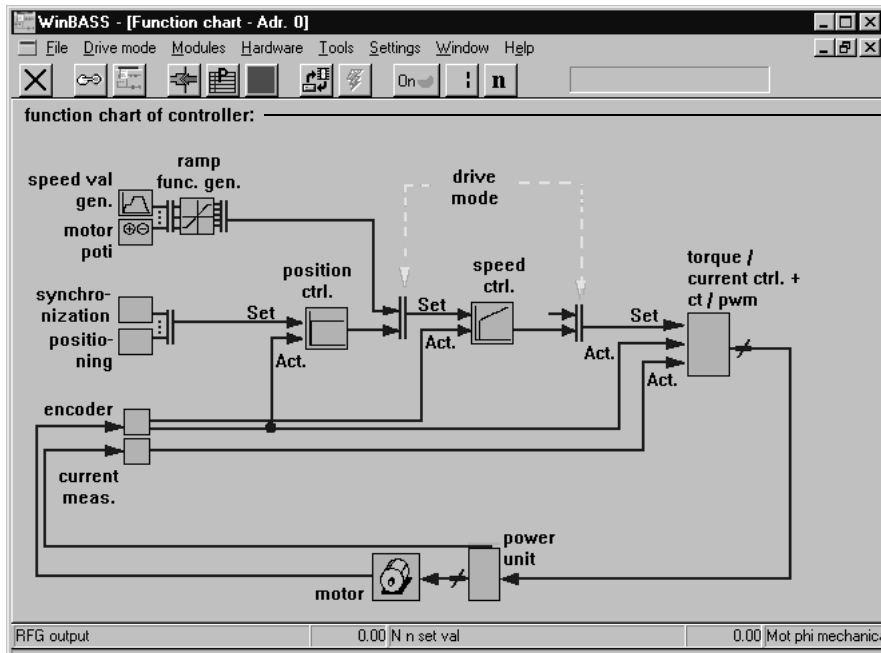

Window name

Click the function block **Synchronization control** to display the window **Synchronization**. From this window you can access all functions of the *synchronization control*.

This window sets the synchronization mode. Select the option **Speed synchronization / relative angle synchronization** from the list field. You may also set the ratio of the electronic gear unit, and the setting options for these parameters will be detailed later in these commissioning instructions.

8.4.1 Speed synchronization / relative angle synchronization

In relative angle synchronization, the position controller of the V-controller tries to keep the position deviation between master and slave axes as small as possible. In this task it is supported by the feed forward control which computes a main setpoint for the speed controller from the continuously arriving setpoint positions. The corrected setpoint of the position controller and the main setpoint make up, in total, the speed setpoint of the slave axis.

Speed synchronization is similar in function, although the position controller is switched off (P gain of the position controller = Cv factor = 0), so that larger position deviations may occur between master and slave axes. In this case, the feed forward control must generate the setpoint speed setpoint completely on its own.

To change the Cv factor, click the button **position control** to display the window **Position controller**.

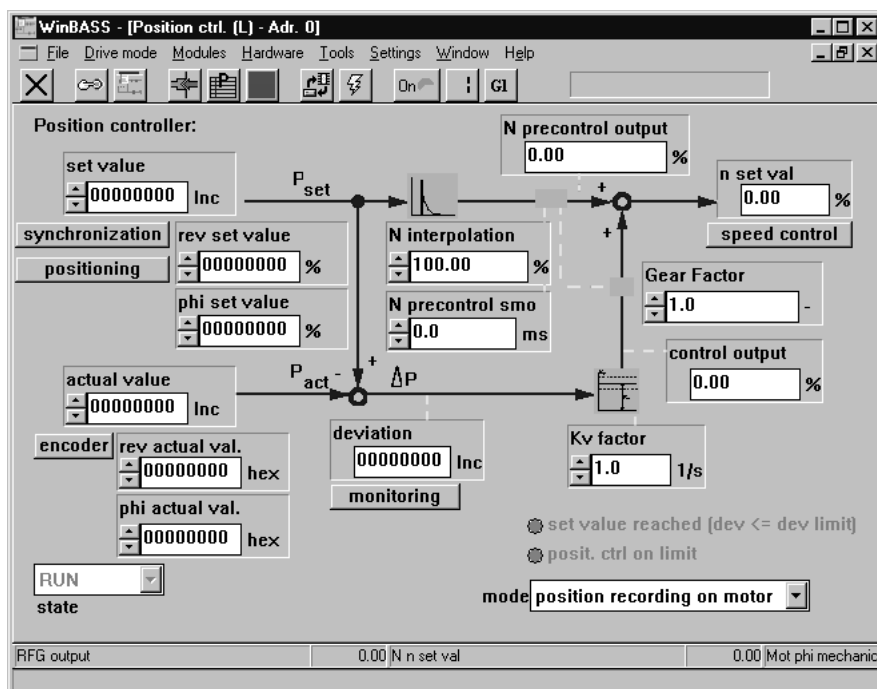

In parameter Cv factor **Kv factor** 1/s enter a value '0' for speed synchronization and a value > 0 for relative angle synchronization. The higher the selected Cv factor, the smaller the following error (deviation between actual position and setpoint position) during operation.

Click the button **X** in the menu bar to close this window and return to the previous window.

The V-controller operating mode must be changed so that the drive may operate in synchronization with a master axis. For this purpose, click the button **n** (operating mode selector) in the menu bar to display an operating mode selection window.

Select the operating mode **Synchronization (GI)** from the list field and click **OK** to confirm your selection.

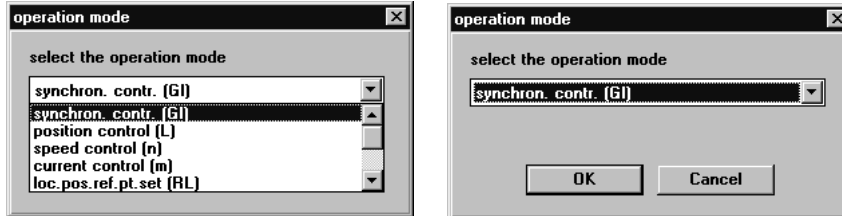

The operating mode selector button in the menu bar now changes its display accordingly: **GI**

Now that all preliminary settings have been made, the drive may be enabled. To start this process, you must set the hardware enable options at the controller (first quick stop, then pulse enable) and then click the button **GLSTART**. The motor (slave axis) is now synchronized with the master axis until the hardware enable options are switched off again and/or until the button **STOP** is clicked.

8.4.2 Electronic gear unit

As a substitute for mechanical gear units that modify the ratio between slave and master axes, the *synchronization control* offers the user the function of an electronic gear unit.

To modify the ratio, enter the desired ratio in parameters 'Revolutions, slave axis' and 'Revolutions, master axis' in the window **Synchronization**.

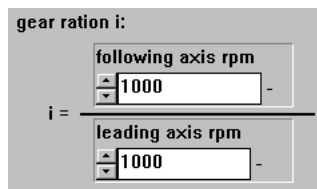

You can also enter negative values into parameter 'Revolutions, slave axis' to implement a reversing gear unit. The ratio may be modified online, which means that modification of one of the two parameters may lead to unwanted ratios. To prevent this, acceptance of a new ratio may be ruled out.

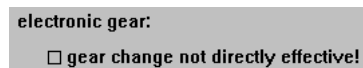

For this purpose, click the box 'Gear unit changes not effective immediately!'. A tick is displayed to confirm this function.

You can now change the ratio without unwanted side effects. Clicking the box 'Gear unit changes not effective immediately!' again revokes the disable function, and the ratio is changed.

8.4 Commissioning

8.4.3 Data security

Store your set data in the non-volatile memory of the controller to avoid loss of data after the controller is switched off.

For this purpose, click the button  (data record administration) in the menu bar to display the window **Data record administration**.

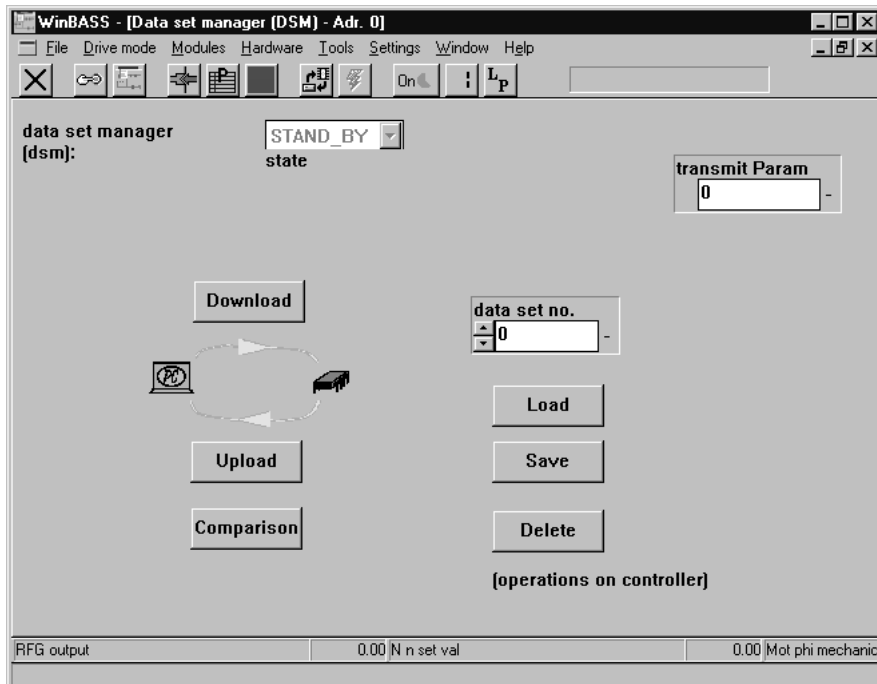

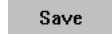
Click the button  to save the programmed data, storing the parameters in data record 0 (= boot data record = the data record that is loaded when the equipment is switched on). A confirmation window is displayed after the successful save. To close it, click 'OK'

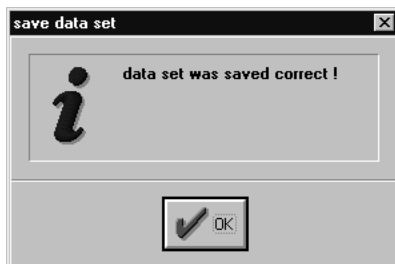

8.4.4 Stand-alone mode

Once the **synchronization control** has been commissioned with the help of WinBASS, we will now explain the expanded parameterization of the V-controller, so that you can operate it as a stand-alone unit without WinBASS.

For this purpose, you must disable the control access (communication source) using RS232/BASS so that the V-controller does not wait for commands from WinBASS.

Select the drive manager by clicking the button  (operating status display).

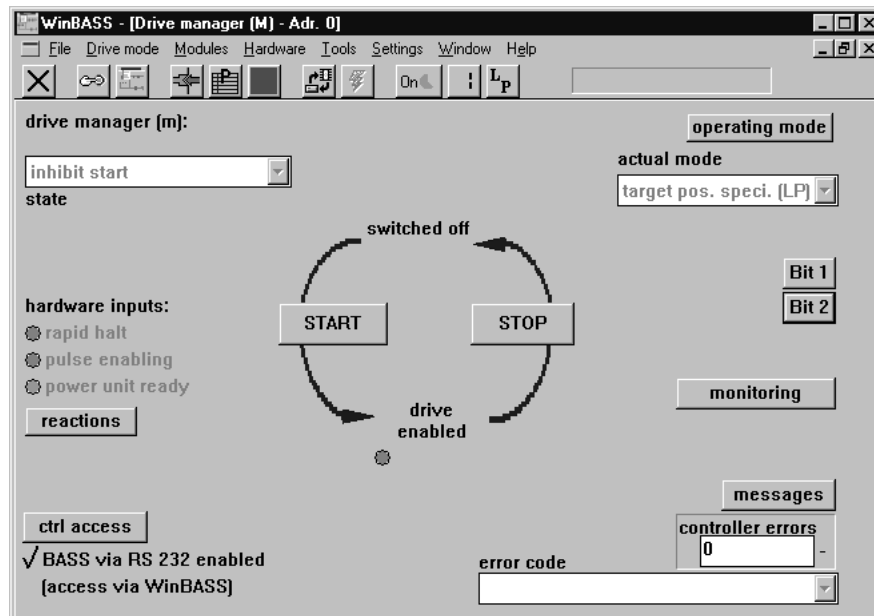

Control access by use of RS232/BASS is currently enabled. Click the tick to disable this function

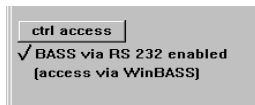

Click the button  in the menu bar to close this window and to return to the previous window.

Save the data record to avoid data loss through equipment disconnection (refer to ►Data security◄ on page 80).

Once you have implemented all the above modifications, the drive will now also operate without WinBASS in the manner described after the hardware signals have been set.

PARAMETERS - SYNCHRONIZATION CONTROL

9.1 List of parameters

Parameter	Name	Range min. ... max.	Unit	Display only
P 250	SY Status	0000 ... FFFF		×
P 251	SY Mode	0000 ... 0013		
P 255	SY Revolutions, slave axis	-32767 ... +32767		
P 256	SY Revolutions, master axis	1 ... 32767		
P 252	SY Compensation factor	1 ... 1000		
P 253	SY Tolerance	0020 ... 7FFF	Inc	
P 257	SY Setpoint position	00000000 ... FFFFFFFF		
P 258	SY Phi setpoint	00000000 ... FFFFFFFF		
P 254	SY Sync. delta	80000001 ... 7FFFFFFF		
P 259	SY Tolerance time	0.000 ... 60.000	s	
P 300	SY N set value	-100.00 ... 100.00	%	
P 324	SY N P-gain	0.1 ... 1000.0		
P 325	SY N reset time	1.0 ... 2000.0	ms	
P 323	SY d_ref 0	0000 ... FFFF	Ink	

P250 SY Status

This parameter defines the status of the synchronization control.

Bit no.	Description
0 ... 3	0: STOP Synchronization OFF 1: RUN Synchronization ON
4	Reserved
5	1: Homing for master axis zero pulse has reached the specified tolerance threshold (only in Homing for master axis zero pulse mode P 251 = 1)
6	1: Homing for master axis zero pulse complete (only in Homing for master axis zero pulse mode P 251 = 1)
7	Reserved
8	1: Synchronous setpoint initialized (only in Synchronous setpoint input mode)
9	1: Current synchronous setpoint available
10	0: Synchronous interpolation active 1: Synchronous extrapolation active
11 ... 15	Reserved

P251 SY Mode

Bit no.	Description
0 ... 3	0000: Speed synchronization and/or relative angle synchronization 0001: Absolute angle synchronization 0010: Reserved 0011: Synchronization with synchronous setpoint input From SW 3.08 1110: Virtual master axis with ramp function generator 1111: Customer specific function
4	0: Transparent mode: All modifications become effective immediately 1: Parameters 'Revolutions, slave axis' and 'Revolutions, master axis' may be edited. The ratio remains unchanged for the time being. 1→0: The modified parameters 'Revolutions, slave axis' and 'Revolutions, master axis' are accepted simultaneously.
5 ... 15	Reserved

P255 SY Revolutions, slave axis

Numerator in the ratio of the electronic gear unit.

P256 SY Revolutions, master axis

Denominator in the ratio of the electronic gear unit.

The ratio of the electronic gear unit function is computed according to the following equation:

$$i = \frac{\text{Rev. slave axis}}{\text{Rev. master axis}} = \frac{P255}{P256}$$

- Denominator and numerator of the ratio consist of integer numbers without decimal places. The numerator may also become negative, thus facilitating the function of a reversing gear unit.
- It is recommended to choose the smallest possible values for P 255 and/or P 256 for the required ratio (only if SW „below“ 04.01 is used).
- The table below lists several ratios with associated parameter values.

i	Revolutions, master axis	Revolutions, slave axis
0.2	10	2
- 0.78	- 100	78
1.15	100	115
9.452	1000	9452
0.3333	10	3

Example: Changing the ratio from 0.8 to 1.15.

With edit
mode = 0
(transparent mode)

Revolutions, master axis	Revolutions, slave axis	Edit mode	Ratio i
10	8	0	0.8
10 → 100	8	0	0.8 → 0.08
100	8 → 115	0	0.08 → 1.15

OR

Revolutions, master axis	Revolutions, slave axis	Edit mode	Ratio i
10	8	0	0.8
10	8 → 115	0	0.8 → 11.5
10 → 100	115	0	11.5 → 1.15



NOTE

Unwanted ratios may occur in transparent mode!

9.1 List of parameters

With edit mode = 1

Revolutions, master axis	Revolutions, slave axis	Edit mode	Ratio i
10	8	0	0.8
10	8	0 → 1	0.8
10 → 100	8	1	0.8
100	8 → 115	1	0.8
100	115	1 → 0	1.15

No unwanted ratios occur with edit mode = 1!

P 257 SY Setpoint position

In 'Synchronization with synchronous setpoint input' mode, these parameters serve as setpoint inputs.

Scalings:

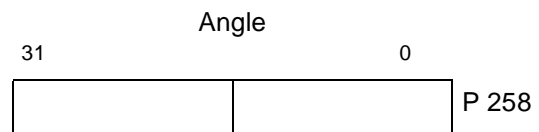
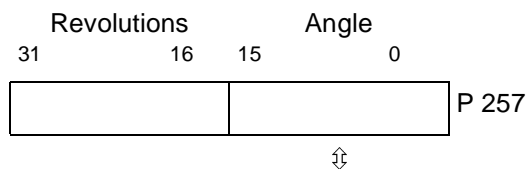

P 258 SY Phi setpoint

In 'Synchronization with synchronous setpoint input' mode, these parameters serve as setpoint inputs.

Scalings:

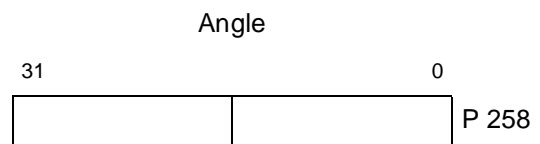
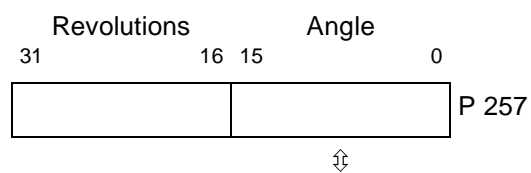

Dependent on P 167 OS Sync.-slot and P 103 PWM Frequency a certain number of bits is masked in P 258. This is necessary, to get for the internal interpolation of the set OS Sync.-slot to the controlling interval an integer.

P 167 OS Sync.-slot [µs]	P 130 PWM Frequency [kHz]	Mask bits P 258
0	4	FFF8 0000
500	4	FFFF FFFC
1000	4	FFFF FFF8
2000	4	FFFF FFF0
4000	4	FFFF FFE0
8000	4	FFFF FFC0
0	8	FFF8 0000
500	8	FFFF FFF8
1000	8	FFFF FFF0
2000	8	FFFF FFE0
4000	8	FFFF FFC0
8000	8	FFFF FF80

The effective value Phi setpoint is displayed in P 258.

P 254

SY Sync. delta

The actual angle delta calculated by the controller is displayed here in operation mode "synchronization with synchronous setpoint input". The value represents the interpolated setpoint change (angle delta / $T_{controlling}$) to the controlling interval.

$$\text{Sync.delta} = \frac{(\text{Phi setpoint}_{\text{new}} - \text{Phi setpoint}_{\text{old}}) \cdot T_{\text{controlling}}}{T_{\text{sync}}}$$

- It is $T_{controlling} = 125 \mu\text{s}$ for P 103 PWM frequency = 4 kHz.
- It is $T_{controlling} = 62.5 \mu\text{s}$ for P 103 PWM frequency = 8 kHz.
- In P 167 OS Sync.-slot is T_{sync} set.

Scalings:

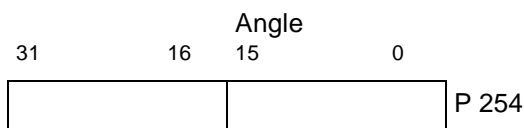

Is P 254 Sync. delta directly set and the parameters P 257 and P 258 are not changed, the setpoint change is executed with the value of Sync. delta.

9.2 Description of synchronization modes

Mode 0 **synchronization (standard function)**

When the drive controller is enabled in the 'Synchronization with electronic gear unit' mode or is switched to this mode online, the system uses the actual positions of master axis and position controller, current at that point in time, as the basis of computation for the electronic gear unit. This means that the rotating shaft (master axis) and the motor (slave axis) have a firm, yet undefined angle relationship with each other from this point onwards. During operation, all master axis position changes are multiplied with gear unit factor i and passed on to the position controller.

$$i = \frac{P255}{P256}$$

When the controller is disabled or the operating mode is changed, any existing angle relationships between master and slave axes will be lost.

Mode 0001 **Synchronization with homing for master axis zero pulse**



NOTE

Both master and slave axes must be designed with incremental encoders with an identical number of marks.

After each controller enable and/or online switchover into this operating mode, the slave axis zero pulse is synchronized with the master axis zero pulse. This is possible only while the master axis is rotating.

At the end of the synchronization process, bit no. 5 is set in SY Status.

Mode 0011 **Synchronization with synchronous setpoint input**

After every controller enable or online change in this operation mode the synchronous setpoint must be initialised. This is done by writing on P 257 SY Setpoint position or P 258 SY Phi setpoint. The first writing on P 257 or P 258 means only an initialisation and no setpoint input. When the synchronous setpoint is initialised, the bit no. 8 in P 250 SY Status is set.

Dependent on the set time interval in P 167 OS Sync.-slot the module expects new setpoints. Is a new setpoint written, the bit no. 9 in SY Status "actual synchronous setpoint available" is set to 1. As soon as the module recognises this new setpoint, the bits nos. 9 and 10 are set to 0 in SY Status and the setpoint interpolation starts.

If the new setpoints are written slower than the set time interval, the modul starts after the set time interval as long as the extrapolation mode until an new setpoint is written. Simultaneously the bit no. 10 "synchronous extrapolation active" is set in SY Status.

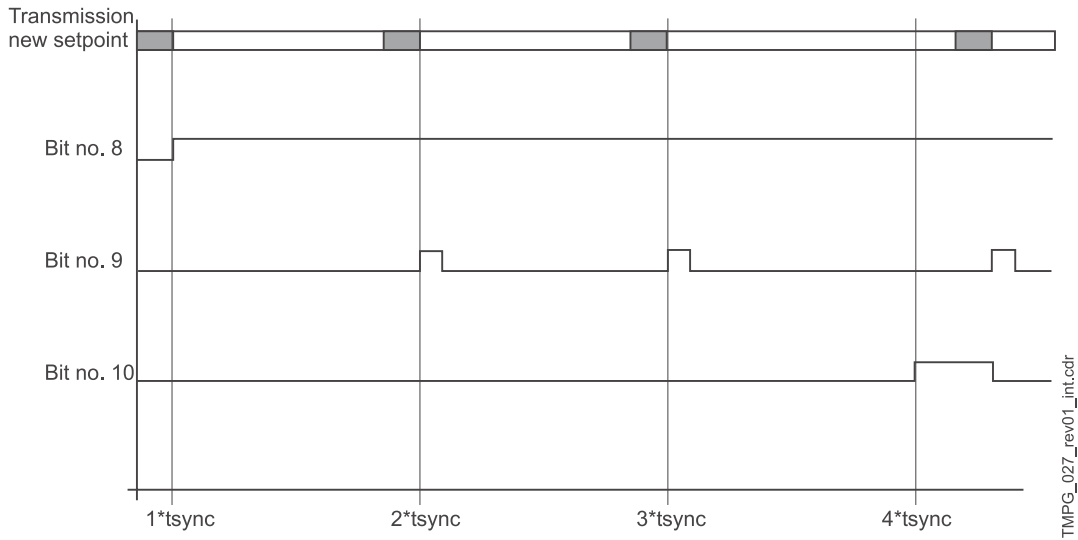

Figure 25: bit 8 to 10 (Synchronization with synchronous setpoint input)

9.3 Overview of synchronization modes

Operating mode P 251	Kv P 202	N feed forward control P 207	Electro- nic gear unit	Reference to master axis zero pulse	Reference to master axis absolute posi- tion	Encoder type
Speed synchronisation	= 0	= 100 %	i = 5	No	No	All
Relative angle synchro- nisation	> 0	= 100 %	i = 5	No	No	All

Mode 1110 **virtual master axis**

Required settings

Parameter	Name	Value
P 122	M Setpoint operating mode	-5 (synchronization)
P 251	SY Mode	000E
P 328	SY Reversing travel	0 (mm)

9.3 Overview of synchronization modes

Mode 0001 absolute angle synchronisation

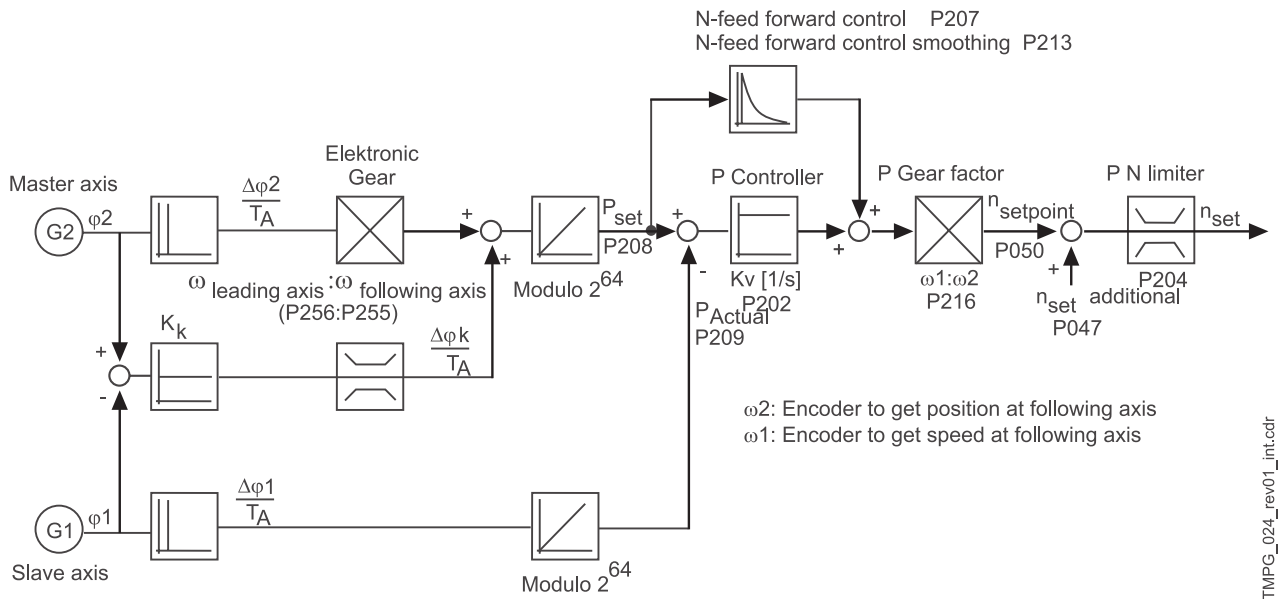

Figure 26: structure of absolute angle synchronisation

Mode 1110 virtual master axis with ramp function generator

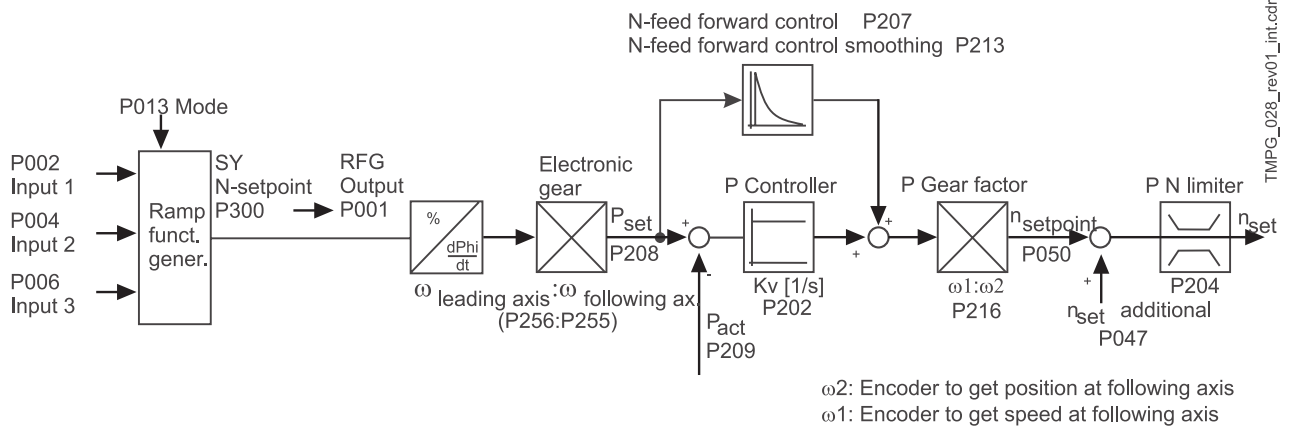

Figure 27: structure of virtual master axis with ramp function generator

You will find additional information in chapter "Ramp function generator", documentation "V-controller", 5.95036.xx.



NOTE

The following parameters are only valid in mode 0001.

P 2 5 2 SY Compensation factor

The speed of the compensation process may be set by using this parameter in 'Absolute angle synchronisation' mode.

P 2 5 3 SY Tolerance
P 2 5 9 SY Tolerance time

The tolerance threshold and the delay time for status bit no. 5 may be set by using this parameter in 'Absolute angle synchronisation' mode.

Scaling: 1 ↔ One encoder increment

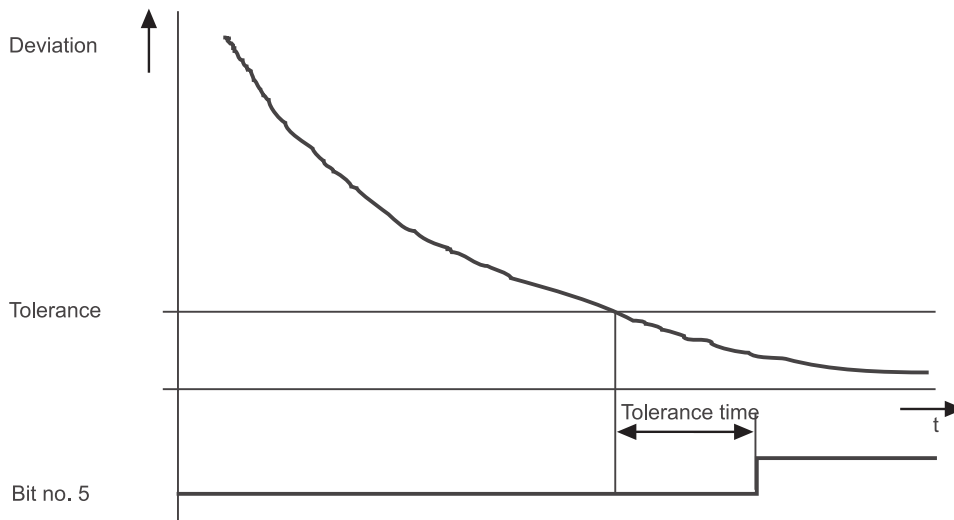

TMPG_028_rev01_int.cdr

Figure 28: Tolerance time (Absolute angle synchronisation)

**NOTE**

The following parameter are only valid in mode 1110.

P 3 2 4 SY N P gain
P 3 2 5 SY N integr. action time

These adjustable values for P gain and integral action time get active in the speed controller when ramp function mode (mode = 1) is activated.

P 3 2 3 SY d_ref 0

Display of deviation (unit: number of marks) referring to the resolution of the encoder used.

P 300 SYN set value

Input for set value for the function "virtual master axis".

Scaling: 100 % ↔ EM maximum speed (P 019)



APPENDIX A - ABBREVIATIONS

+ IAist 	Absolute value of armature current actual value (pos. signal)	DA	Digital/analog
AO	Function module Analog Outputs	DAC	Digital/analog converter
AC	Alternating current	DB	Data byte (8 bit)
ADR	Adress byte	DC	▶ Direct current ▶ Drive-Control
AI	Function module Analog Inputs	DE	Function module Digital Inputs
AK	Request-/answer code	DES	Digital input actuator
AM	▶ Asynchronous motor ▶ Function module Drive-Manager	DIN	'Deutsches Institut für Normung e.V.', German institution for standardization
ASF	Armature contactor enable	DOPPELW	Double word (32 bit)
BAPS	Baumüller drives parallel interface	DSV	Function module Data Set Management
BASS	Baumüller drives serial interface	DW	Data word (16 bit)
BB	Ready for operation	DWort	Double word (32 bit)
BBext	Readiness for operation (external)	EMK	Electromagnetic constant
BBint	Readiness for operation (internal)	EMC	Electromagnetic compatibility
BCC	Block check character	EN	European standard
BE	▶ Component (corresp. to "UU") ▶ Operator's station	EOF	End of file
BEDAS	Operating data memory	ES	Function module Incoming Feeder
BOF	Begin of file	Ext	Function module Current Monitoring
BS	Function module operating system	EXT, ext	External
BSA	Analog reference potential	FBS	BEDAS missing
BSD	Digital reference potential	FI	Fault current
BSE	External reference for 24 V controller inputs	FLG	Error position encoder signal
BUB	Ballast unit	FPH	Missing phase
BUC	Baumüller incoming-/feedback unit	FTO	Error tacho signal
BUG	Baumüller converter basic incoming unit	GL	Technology module Synchronous Operation
BUM	Baumüller single power unit	GRE	Rectifier end position
BUS	Baumüller power module	HE	Mains contactor ON
CPU	Central processing unit		

HLG	Function module Ramp-function Generator	Mot	Function module Field Angle Computing
HM	Main menu	MR1	Torque direction 1
HS	Mains contactor	MR2	Torque direction 2
HSE	Mains contactor ON	MT	Function module Motor Temperature
HSF	Mains contactor enable	mtr.	Medium time-lag fuse
HW	► High word ► Hardware	n = 0	Speed = 0
I	Function module Current Control	N	Function module Speed Controller
I2t	Function module Overload Monitoring	n_{ist}	Speed actual value
I_{Aist}	Armature current actual value	n_{max}	Maximum speed
IKG	Function module Incremental encoder	n_{min}	Minimum speed
ID-Nr.	Identification number	NMX	Maximum speed exceeded
I_F	field current	NN	Altitude above sea level
I_{Fmax}	Maximum field current (rated current)	n_{SG}	Creep feed speed
I_{Fmin}	Minimum field current	n_{soll}	Speed setpoint value
I_{Fsoll}	Filed current setpoint value	P	Identification number
Inc	Counting unit of position encoder	PBE	Parameter description
IND	Index	PELV	Protective extra-low voltage
Ink	Stroke character number of incremental encoder	PKE	Parameter identifier
INK.	Incremental	PKW	Parameter identifier value
KT	Function module Coordinate transformation	PNU	Parameter number
IPM	Intelligent power module	POS	Technology module Positioning
I_{soll}	Armature current setpoint value	PWE	Parameter value
IW	Actual value	PWM	Function module Pulse-width Modulation
IWK	Actual value channel	PZD	Process data
IxR_{service}	IxR-compensation with "service"	R	Reserved
IxR_{creep speed}	IxR-compensation with "creep speed"	R_A	Armature resistance
IZK	Overcurrent in DC link	RA	Function module Relais Output
KT	Function module Coordinate Transformation	Res	Function module Resolver Evaluation
L	Function module Position Control	RF	Controller enable
LED	Light-emitting diode	RS	Controller blocking
LGE	Telegram length	SE	Screen earthing
LT	Function module Power Module	SELV	separated extra low voltage system
LW	Low word	SF	Following error
M	Function module Drive-Manager	SGR	Current limit reached
M24	Reference potential 24 V	SH	Quick stop
MM	► Function module Motor Model ► Torque detector	SL	Protective earth conductor
\$	Prefix for hexadecimal number	SM	Synchronous motor
		STX	Start of text
		SV	Function module Service Interface

SW	▶ Setpoint value ▶ Software
SWG	Function module Setpoint Value Generator
SWK	Setpoint value channel
TBA	Overtemperature ballast resistor
TKK	Overtemperature heat sink
TM	Temperature of motor
TMO	Overtemperature of motor
U_A	Armature voltage
UM	Submenu
USS	Function module USS-protocol
UVS	Supply voltage too low
USS[®]	Siemens trademark universal serial interface
U_{ZK}	DC link voltage
VBG	“Verwaltungs-Berufsgenossen- schaft”, German management occupation- cooperative
VDE	“Verband deutscher Elektrotechni- ker” German electrical engineer con- nected
VE	Logic element
WRE	Inverter limit position
X	Terminal strip
ZK	DC link





APPENDIX B - LIST OF PARAMETERS

	Parameter	Standard value	Internal scaling	Page
-	P250 SY Status	-	1:1	84
X	P251 SY Mode	0000	1:1	84
X	P252 SY Compensation factor	1	1:1	91
X	P253 SY Tolerance	0064 Inc	1:1	91
X	P254 SY Sync. delta	0000 0000	1:1	87
X	P255 SY Revolutions, slave axis	1000	1:1	84
X	P256 SY Revolutions, master axis	1000	1:1	84
-	P257 SY Setpoint position	0000 0000 Inc	1:1	86
-	P258 SY Phi setpoint	0000 0000	1:1	86
X	P259 SY Tolerance time	1.000 s	1.000 s = 1000 dec	91
X	P300 SY N set value	-	±100.00 % = ±16384 dec	92
-	P306 SP State	-	1:1	69
X	P307 SP Mode	0000	1:1	69
X	P308 SP Position angle	0000	1:1	69
X	P309 SP Position speed	1.00 %	100.00 % = 16384 dec	70
X	P310 SP Deceleration	5.00 l/ms ²	1:1	70
X	P323 SY d_ref 0	0	1:1	91
X	P324 SY N P gain	10.0	10.0 = 100 dec	91
X	P325 SY N integr. action time	25.0 ms	25.0 ms = 250 dec	91
-	P400 POS Module status	-	1:1	31
X	P401 POS Current record no.	1	1:1	31
X	P402 POS Pos. scaling N	1 l	1:1	31
X	P403 POS Pos. scaling D	1 BE	1:1	31
X	P406 POS Mode	0001	1:1	32
X	P408 POS Stop deceleration	5.00 l/ms ²	1.00 l/ms ² = 100 dez	33
X	P409 POS Jogging speed	480 l/ms	1:1	33
X	P410 POS Jogging acceleration	2.00 l/ms ²	1.00 l/ms ² = 100 dec	33
X	P411 POS Jogging deceleration	2.00 l/ms ²	1.00 l/ms ² = 100 dec	33
X	P412 POS Homing speed	480 l/ms	1:1	33
X	P413 POS Homing acceleration	5.00 l/ms ²	1.00 l/ms ² = 100 dec	33

X: Parameter is saved in the data record

	Parameter	Standard value	Internal scaling	Page	
X	P414	POS Homing mode	1001	1:1	33
X	P415	POS Target position 1	0000 0000 BE	1:1	46
X	P416	POS Target input 1	0	1:1	47
X	P417	POS Pos. speed. 1	100 l/ms	1:1	47
X	P418	POS Final speed 1	0 l/ms	1:1	47
X	P419	POS Pos.acceleration 1	5.00 l/ms ²	1.00 l/ms ² = 100 dec	47
X	P420	POS Pos deceleration 1	1.00 l/ms ²	1.00 l/ms ² = 100 dec	47
X	P421	POS Dwell time 1	1 ms	1:1	47
X	P422	POS Target position 2	0000 0000 BE	1:1	46
X	P423	POS Target input 2	0	1:1	47
X	P424	POS Pos. speed 2	100 l/ms	1:1	47
X	P425	POS Final speed 2	0 l/ms	1:1	47
X	P426	POS Pos acceleration 2	5.00 l/ms ²	1.00 l/ms ² = 100 dec	47
X	P427	POS Pos deceleratoin 2	1.00 l/ms ²	1.00 l/ms ² = 100 dec	47
X	P428	POS Dwell time 2	1 ms	1:1	47
X	P429	POS Pos. window	0000 1000 BE	1:1	40
X	P430	POS Pos. window time	2 ms	1:1	41
X	P431	POS Backlash compensation	0000 0000 BE	1:1	41
X	P432	POS Home position	0001 0000 BE	1:1	41
-	P433	POS Status-switch	-	1:1	41
X	P434	POS Modus Schalter	0000	1:1	42
X	P435	POS Encoder offset	0 l	1:1	43
-	P436	POS Setpoint position	-	1:1	43
-	P437	POS Actual position	-	1:1	43
-	P438	POS Setpoint speed	-	1:1	44
X	P439	POS SW limit switch 1	0000 0000 BE	1:1	44
X	P440	POS SW limit switch 2	FFFF FFFF BE	1:1	44
X	P441	POS Rounding	0 ms	1:1	48
X	P442	POS Homing deceleration	5.00 l/ms ²	1.00 l/ms ² = 100 dec	45
X	P443	POS Final homing speed	10 l/ms	1:1	45
X	P444	POS Clip environment 1	0001 0000 BE	1:1	45
X	P445	POS Clip environment 2	0001 0000 BE	1:1	45
X	P446	POS Bend S-curve	20 l/(16ms ³)	1:1	48
X: Parameter is saved in the data record					

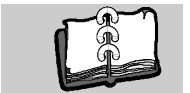

Table of Figures

structure of module position control	9
target input = 0 (absolute positioning sequence)	11
target input = 1 or -1 (relative positioning sequence)	12
Positioning - mechanical setup	13
Positioning - electrical terminating resistor connector X26	13
drive operation - chart (stand-alone mode positioning)	28
homing - negative limit switch	36
homing - positive limit switch	37
homing - positive home switch	37
homing - negative home switch	38
position of home position	50
Time optimized positioning (trapezoid profile of speed)	57
Time optimized positioning with rounding = 10 ms (PT1)	58
Jerk limited positioning (S-curve profile of speed) with bend = 2	58
Jerk limited positioning (S-curve profile of speed) with bend = 10	58
Comparison of curves (trapezoid profile and S-curve profile)	59
Example positioning	62
speed time diagram (positioning)	65
Speed actual value > SP Position speed	70
Speed actual value > SP Position speed	71
Speed actual value = 0 (N-message of motor leading encoder set)	71
structure of synchronization control	74
Mechanical setup - overview	75
Diagram of the electrical terminating resistor connector X26	75
bit 8 to 10 (Synchronization with synchronous setpoint input)	89
structure of absolute angle synchronisation	90
structure of virtual master axis with ramp function generator	90
Tolerance time (Absolute angle synchronisation)	91

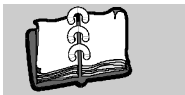
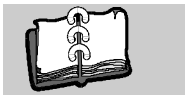

Table of Figures



Index

A			
Angular relationship			
Master axis – Slave axis	73		
C			
Commissioning	7, 14, 73		
Communication source	27		
D			
Danger	5		
Data security	23		
E			
Electronic gear unit	74		
Encoder systems	8		
Example of an application	61		
G			
Gear unit			
Electronic	74, 84		
Global parameters	29		
H			
Homing	15, 30, 34, 49		
J			
Jogging	30		
M			
Manual mode	55		
Master axis	88		
Virtual	89		
P			
Parameters	29		
Positioning modes	57		
Positioning record-specific parameters	46		
S			
Safety notes	5		
Scaling	30		
Slave axis	88		
Spindle positioning	67		
Synchronization			
Modes	89		
Synchronization control	83		
T			
Target position input	30, 53		
Testing	49		
Tme optimized positioning	57		
V			
V-controller			
		Standalone	24
		Virtual master axis	89
W			
Warning			6
Z			
Zero pulse			
Of the slave axis			73
Synchronization			88



be in motion

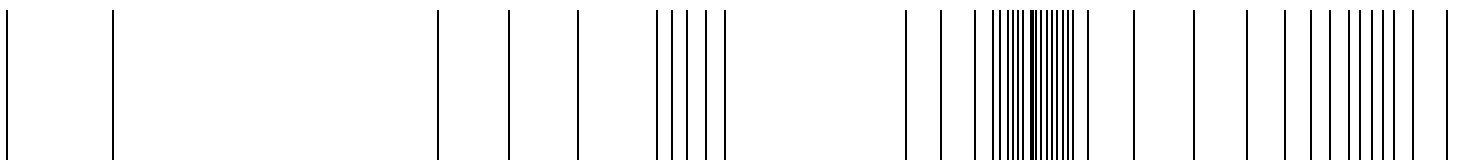

Baumüller Nürnberg GmbH Ostendstraße 80-90 90482 Nürnberg T: +49(0)911-5432-0 F: +49(0)911-5432-130 www.baumueller.de

All information given in this manual is customer information, subject to change without notice. We reserve the right to further develop and actualize our products continuously using our permanent revision service. Please notice, that specifications/data/information are current values according to the printing date. These statements are not legally binding according to the measurement, computation and calculations. Before you make any information given in this manual to the basis of your own calculations and/or applications, please make sure that you have the latest edition of the information in hand. No liability can be accepted concerning the correctness of the information.