



| | |
|----------|------------|
| E | 5.99063.03 |
|----------|------------|

BAUMÜLLER

**TECHNOLOGY MODULE
CAM DISK WITH REGISTER
CONTROL OPTION**

Technical Description and
Operating Instructions

As of 22 December 1999

BAUMÜLLER

TECHNOLOGY MODULE CAM DISK WITH REGISTER CONTROL OPTION

Technical Description and Operating Instructions

As of: 22 December 1999

5.99063.03

READ AND OBSERVE THE OPERATING INSTRUCTIONS
AND
SAFETY INFORMATION CAREFULLY PRIOR TO
COMMISSIONING

These operating instructions contain the information required for the application as directed of the products described herein. The document is intended for specially trained, skilled personnel who are well-versed in all warnings and maintenance activities. The units are manufactured using the state-of-the-art technology and are safe in operation. They can be installed safely and commissioned and function without problems if the safety information is observed.

Commissioning is prohibited until it has been established that the machine into which this component is installed, complies to the CE Machinery Directive.

With the handover of the this technical description and these operating instructions all previous descriptions of the products are no longer valid. Baumüller reserves the right in further developing its products, to modify the technical data and the handling of the products concerned.

No liability can be accepted concerning the correctness of the product information unless otherwise specified in the General Conditions of Sale and Delivery.

**Manufacturer's and
delivery address** Baumüller Nürnberg GmbH
Ostendstr. 80 - 90
D-90482 Nürnberg
Tel. ++49 9 11/54 32 - 0
Telefax ++49 9 11/54 32 - 1 30

Copyright: Reproduction of these operating instructions or any of its contents is not permitted without our express written consent.

TABLE OF CONTENTS

| | | |
|----------|--|-----------|
| 1 | Safety notes | 5 |
| 2 | Commissioning | 7 |
| 2.1 | How it works | 7 |
| 2.1.1 | What is an electronic cam disk? | 7 |
| 2.1.2 | What is a register control? | 8 |
| 2.2 | Structure | 11 |
| 2.3 | Commissioning sequence | 12 |
| 2.4 | Applicable documents | 13 |
| 2.5 | Installation requirements | 13 |
| 2.5.1 | PC hardware and software | 13 |
| 2.5.2 | Baumüller software | 13 |
| 2.5.3 | Baumüller hardware | 14 |
| 2.6 | Commissioning instructions | 18 |
| 2.6.1 | Determine the "online" mode | 18 |
| 2.6.2 | Selection of the technology module and specification of the version number | 19 |
| 2.6.3 | Central user interface of the technology module | 20 |
| 2.6.4 | Hardware | 21 |
| 2.6.5 | Configuration | 22 |
| 2.6.6 | User data | 23 |
| 2.6.7 | Setpoint mode selection | 30 |
| 2.6.8 | Master axis setting angle | 31 |
| 2.6.9 | Master axis simulation | 31 |
| 2.7 | Register control commissioning | 32 |
| 2.7.1 | Hardware setting | 33 |
| 2.7.2 | Configuration | 34 |
| 2.7.3 | Register controller | 35 |
| 2.7.4 | Mark check | 36 |
| 3 | Operation | 39 |
| 3.1 | Operation via WinBASS | 41 |
| 3.2 | Operation via 24-V interface MFM | 42 |
| 3.2.1 | Input address assignment | 42 |
| 3.2.2 | Output address assignment | 44 |
| 3.3 | Operation via CANsync bus | 46 |
| 3.3.1 | Assignment of the control word | 46 |
| 3.3.2 | Assignment of the status word | 48 |
| 4 | Windows and parameters | 51 |
| 4.1 | Central user interface window | 51 |
| 4.2 | User data window | 54 |
| 4.3 | Hardware configuration window | 55 |
| 4.4 | Register control – controller window | 56 |
| 4.5 | Mark check window | 58 |
| 4.5.1 | Setpoint mode selection window | 60 |
| 4.5.2 | Master axis setting angle window | 61 |
| 4.5.3 | Master axis simulation window | 62 |

Table of Contents

| | |
|--|-----------|
| 5 Troubleshooting | 63 |
| 5.0.1 Detail error list – addr. 0 window | 63 |
| 5.0.2 Error detail list Omega – addr. 0 window | 63 |
| 6 Appendix | 64 |

1 SAFETY NOTES

General information

These operating instructions contain the information required for the application as directed of the products described herein. The document is intended for specially trained, skilled personnel who are well-versed in all warnings and maintenance activities. The units are manufactured using the state-of-the-art technology and are safe in operation.

They can be installed safely and commissioned and function without problems if the safety information below is observed.



DANGER

When operating this electrical unit, some parts of the equipment always carry dangerous voltage.

Ignoring these safety instructions and warnings may result in death, serious personal injury and/or damage to material assets.

Only qualified personnel who are familiar with the safety information, assembly, operation and maintenance instructions may carry out work on this unit.

Danger information

One the one hand, the information below is for you own personal safety and on the other to prevent damage to the described products or to other connected units.

In the context of the operating instructions and the information on the products themselves, the terms used have the following meanings:



DANGER

This means that **death, severe personal injury or considerable damage to material assets** will **occur**, unless appropriate safety measures are taken.



WARNING

This means that **death, severe personal injury or considerable damage to material assets** may **occur**, unless appropriate safety measures are taken.



NOTE

This draws your attention to **important information** about the product, handling of the product or to a particular section of the documentation.

Qualified personnel

Qualified personnel in the sense of the safety-relevant information in this document or on the products themselves, qualified personnel are considered to be persons who are familiar with setting up, assembling, commissioning and operating the product and who have qualifications appropriate to their activities.

- Trained or instructed or authorised to commission, ground and mark circuits and equipment in accordance with recognised safety standards.
- Trained or instructed in accordance with recognised safety standards in the care and use of appropriate safety equipment.

Application as directed



WARNING

You may only use the unit/system for the purposes specified in the operating instructions and in conjunction with the third-party equipment and components recommended or authorised by BAUMÜLLER NÜRNBERG GmbH.

For safety reasons, you must not change or add components on/to the unit. The operator must report immediately any changes that occur which adversely affect the safety of the unit/system.

2 COMMISSIONING

2.1 How it works

In mechanical engineering, complex movements are achieved using mechanical cam disks now as before. These mechanical cam disks are characterised by a fixed relationship between master and server axes. The disadvantage of this procedure are long setting-up times and the restriction to a defined profile. The mechanical design does not allow high cycle times for this procedure.

These complex movements can be achieved by electronic cam disks and servo technology.

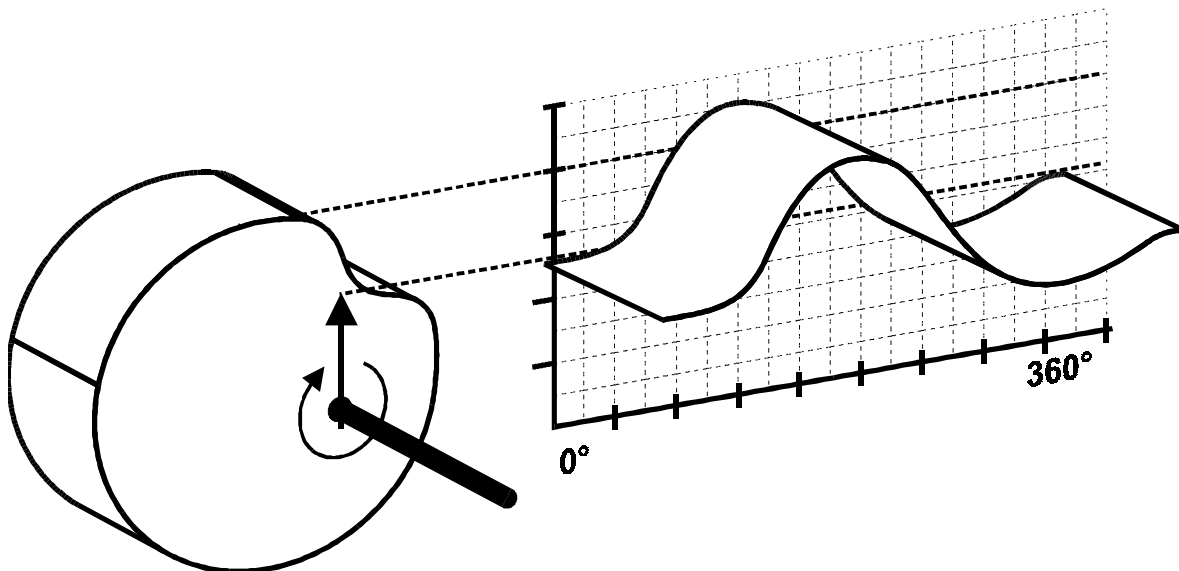

Fig: 1 Function of the cam disk

2.1.1 What is an electronic cam disk?

When using an electronic cam disk, either an encoder detects the movement of the real master drive or a virtual master is used. The control generates the setpoint of the slave axis and controls a servo motor according to the desired profile which is defined in the form of an interpolation point memory.

The interpolation point memory is processed cyclically. Every cycle corresponds to a revolution of the cam disk.

This electronic cam disk saves a lot of resetting time when another product size is to be manufactured and it enables the positioning to be modified during production which represents a considerable cost reduction.

For the connection of several mechanical modules, Baumüller offers the synchronous CANsync fieldbus. This fieldbus replaces the mechanical longitudinal shaft (line shaft).

The technology module *cam disk with register control option* has been developed for the hardware **Ω**mega DriveLine. The **Ω**mega DriveLine is a configurable open- and closed-loop control board and is installed next to the V-controller in the standard compartment of all Baumüller power units or power modules.

The most important features of the technology module *Cam disk with register control option* are:

- You can use and select up to 32 curves in the form of a table memory. The cam disk can have a maximum of 16384 interpolation points.

| Curves | Interpolation points |
|--------|----------------------|
| 32 | 512 |
| 16 | 1024 |
| 8 | 2048 |
| 4 | 4096 |
| 2 | 8192 |
| 1 | 16384 |

- You can select another curve online.
- A 32-bit position setpoint is available at the output of the cam disk.
- The integrated pilot speed control minimises the following error of the cam disk.
- A fine interpolation is performed between the individual interpolation points.
- You can use six different modes for the online change of the characteristic.
- The individual cam disks can be carried out conveniently on the PC using a spreadsheet software. The cam disk is created by defining a mathematical function or entering few points for **linear** or **spline** interpolation.

Possible applications for the technology module *Cam disk with register control option* are found in the packaging industry (e.g. bag forming, filling, and sealing machine) textile industry (e.g. looms) and in the printing industry (e.g. punching, perforating).

2.1.2 What is a register control?

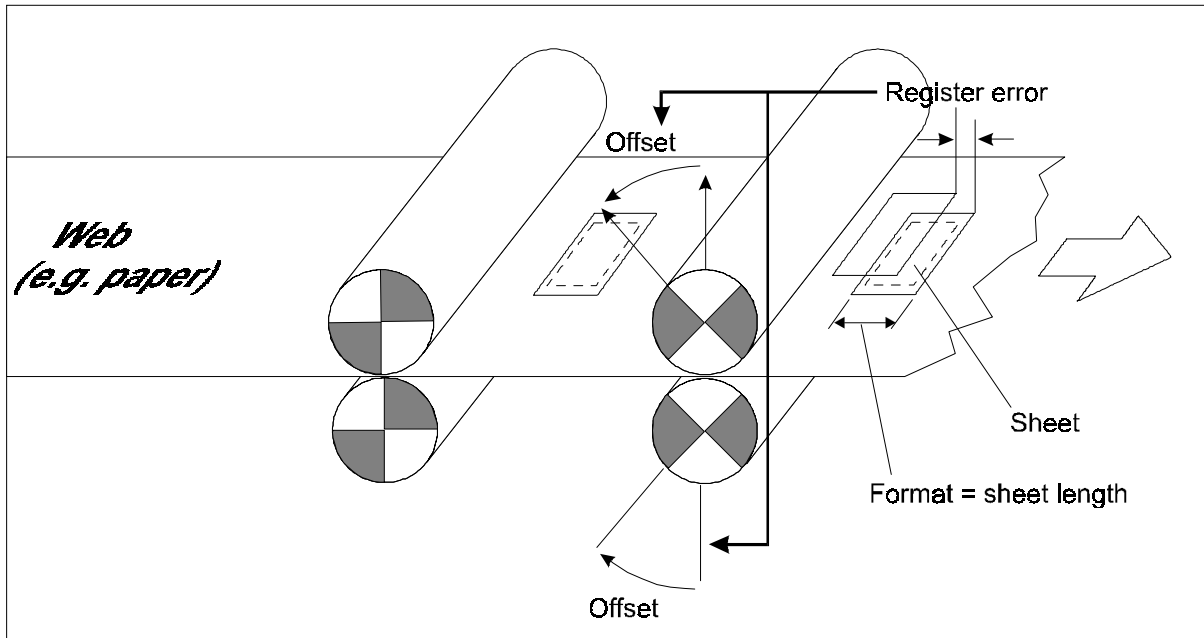

Fig: 2 Mode of functioning of the register control

The drive acts on the axis via the cam disk. It is necessary to perform an alignment to the processing function of the sheet to be processed (see figure "Mode of functioning of the register control" on page 8). Printing, punching or feeding of the web material is thus in-register.

A mark is printed on every sheet or format. The position of the mark is detected by an optical sensor and an encoder. The difference between the actual and the setpoint position can now be adjusted.

The register control is basically suitable for all machines where a workpiece is processed on several stations moving synchronously and the workpiece must be processed in-register.

The task of the register control is to compensate ambient influences and thus to ensure that all stations are in-register.

The register control function has a higher level than the cam disk and can be deactivated any time, e.g. for individual processing, where absolute processing functions do not have to be maintained.

In-register accuracy

The accuracy of the register control depends on the resolution of the connected incremental encoder system. The detection of the position with a counter frequency of 4 MHz via the counter input allows the connection of high-resolving incremental encoder systems.

The register offset acts on the ratio of an electronic gear and is calculated once for every format. The ratio results in a phase shift of the cam disk function.

Mark detection

Depending on the organisation of the processing stations, one or more marks can be printed on the format (format = sheet length). The mark which is relevant for the drive is selected using a filter in the measured format. In the simplest case, only one mark is printed and the filter is configured once to the format length.

The marks are detected using an optical sensor with 24V/DC industrial logic. If a sensor detects a mark (latch), its position is saved using an encoder. This position can then be evaluated by the system. A latch counter is incremented and shows the correct operation of the sensor.

Mark checking

Since several marks can be set for a format, the system checks the parameterised phase interval of the mark.

The register offset can be limited using a configurable tolerance area.

If the system does not find a mark in the parameterised interval, a check counter is incremented. An error is set when the parameterised limit is reached. When a mark is detected again, the check counter is decremented and reset to zero.

Minimised mark distance

Depending on the web speed, the evaluation cycle of 2 ms permits mark distances of a few millimetres. The mark length can be varied.

Complete process overview and check

The length and number of the formats to be processed, the number of detected marks, the averaged setpoint and the actual value as well as register errors can be checked online.

You can also change the setpoint manually any time. The limits are corrected automatically.

You can add a switch-off function (check of missing marks) to the control process. The switch-off function only causes the current register position to be maintained in the current operation. You can acknowledge the error and restart the register control any time.

2.2 Structure

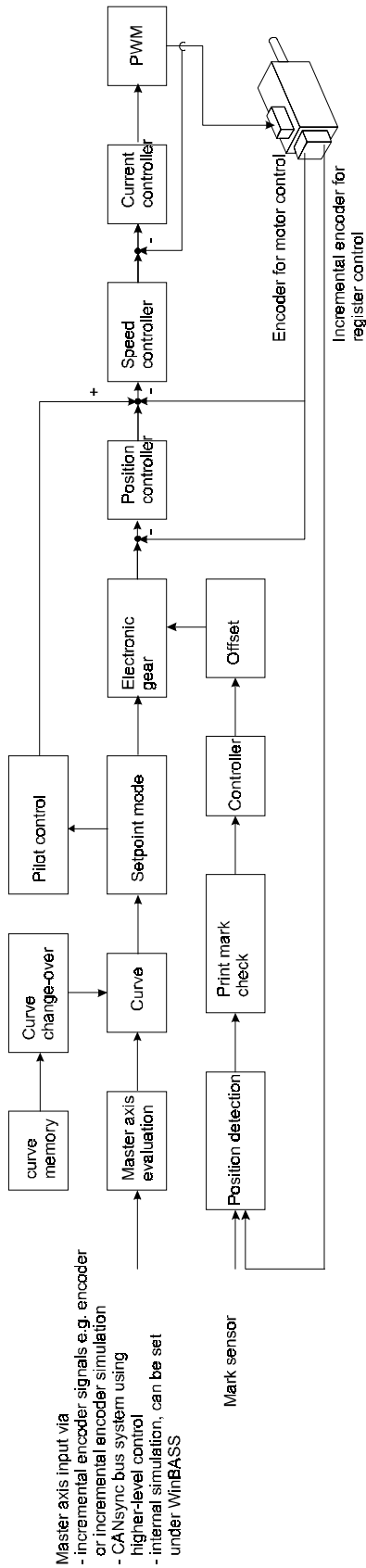

Fig: 3 Structure of the technology module cam disk with register control option

2.3 Commissioning sequence

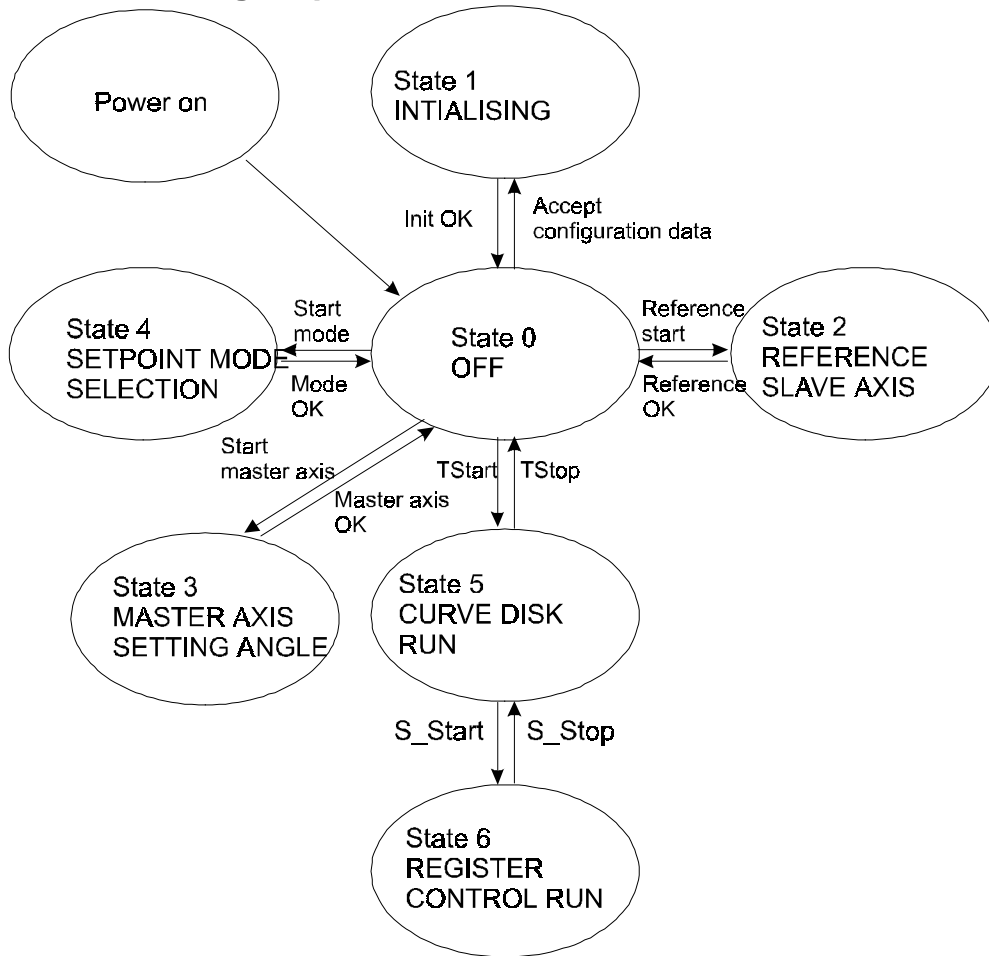

Fig: 4 Flow chart of "Commissioning via WinBASS"

State 0: OFF

The cam disk with register control option is not enabled. When the cam disk with register control option is enabled via **Tstart** the technology module changes to state 5. CAM DISK RUN. When the configuration data has been accepted, the technology module changes to state 1. INITIALISING

State 1: INITIALISING

After the technology module *cam disk with register control option* has been switched on, it is in the initialising phase.

State 2: HOMING SLAVE AXIS

The drive moves to the home position according to the method entered in WinBASS (see documentation "Technology modules Positioning and Synchronisation V-controller" 5.96187.xx). In this technology module, the start of homing is performed only. After successful homing, the controller changes to state 0. OFF.

State 3: MASTER AXIS SETTING ANGLE

The setting angle is set in WinBASS under **Master axis setting angle**. After the setting has been accepted, the controller changes to state 0. OFF.

State 4: SETPOINT MODE SELECTION

The cam disk control mode is set under **Setpoint Mode Selection** in WinBASS. After the setting has been accepted, the controller changes to state 0. OFF.

State 5: CAM DISK RUN

The drive is moved according to the settings of the technology module. The register control is

deactivated. The drive changes to state 0 using **TStop**: OFF. The drive changes to state 6 using **S_Start**: REGISTER CONTROL RUN.

State 6: REGISTER CONTROL RUN

The drive is moved according to the settings of the technology module. The register control is activated. The drive changes to state 5 using **S_Stop**: CAM DISK RUN, the register control is deactivated.

2.4 Applicable documents

The software of the technology module is part of a drive package which consists of the following components:

- Motor
- Power unit
- Controller
- Control

Technical descriptions/Operating instructions are supplied separately. It is assumed that you have previously read and understood these instructions and pay special attention to the warnings.

| Description | German (part no.) | English (Part no.) |
|---------------------|--------------------------|---------------------------|
| V-controller 3.xx | 242916 | 243131 |
| Omega-DriveLine | 221617 | 238165 |
| Option board MFM-01 | 221714 | - |
| Option board IEI-02 | 221716 | - |

2.5 Installation requirements

2.5.1 PC hardware and software

IBM-compatible PC with

- pentium processor with at least 133 MHz (200 MHz recommended)
- at least 32 MB RAM (64 MB recommended)
- 60 MB free hard disk memory
- CD-ROM drive
- VGA monitor with colour settings: 256 colours or more. Resolution: 800 x 600 or higher
- free serial interface (COM1...COM4)

Operating system: Windows[®] 95 or Windows[®] NT 4.0

2.5.2 Baumüller software

WinBASS user interface V4.xx or higher.

2.5.3 Baumüller hardware

V-controller in one of the following four configurations.

- **Omega-DriveLine** for the setting of the master axis and control of the technology module via CANsync without using the register control option.

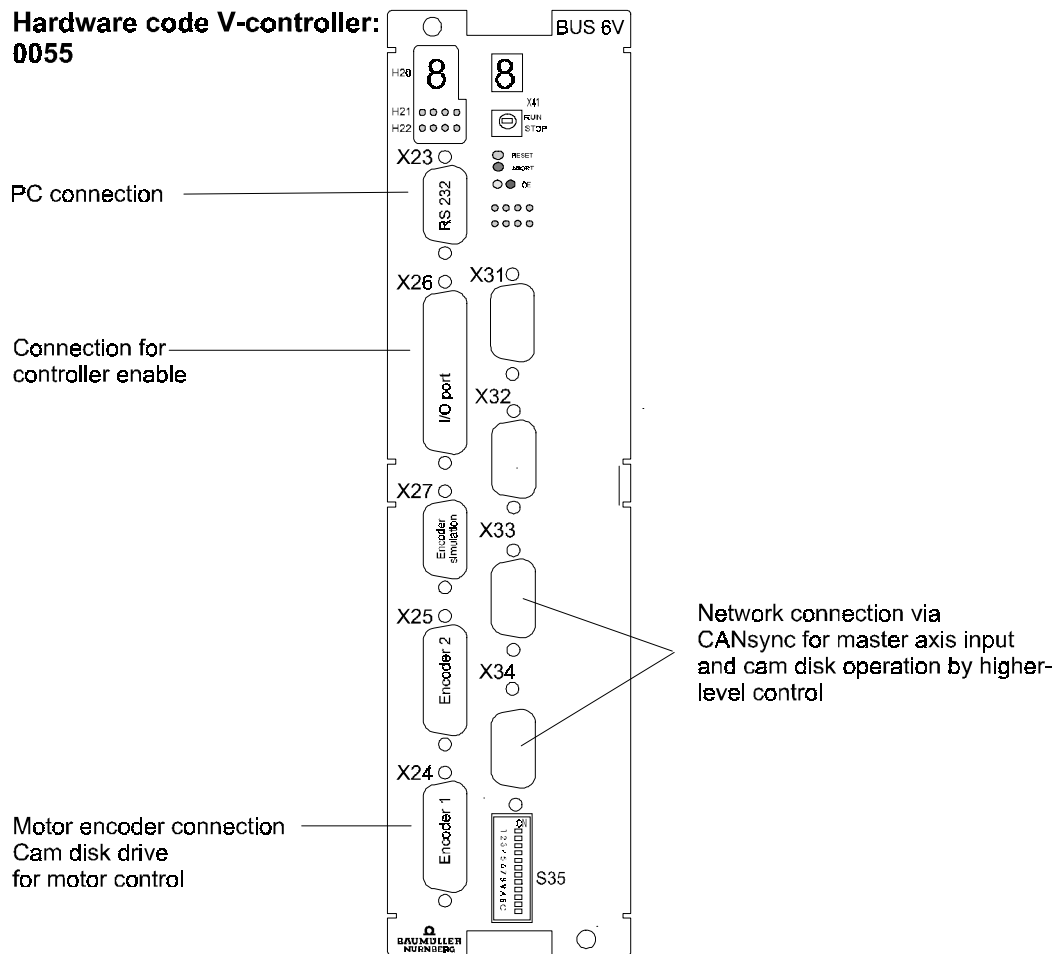

Fig: 5 V-controller, configuration 1

- Omega-DriveLine with incremental encoder option board IEI-02 for the setting of the master axis by incremental encoder signals and use of the register control option and control of the technology module via CANsync. The master axis can also be set via CANsyn.

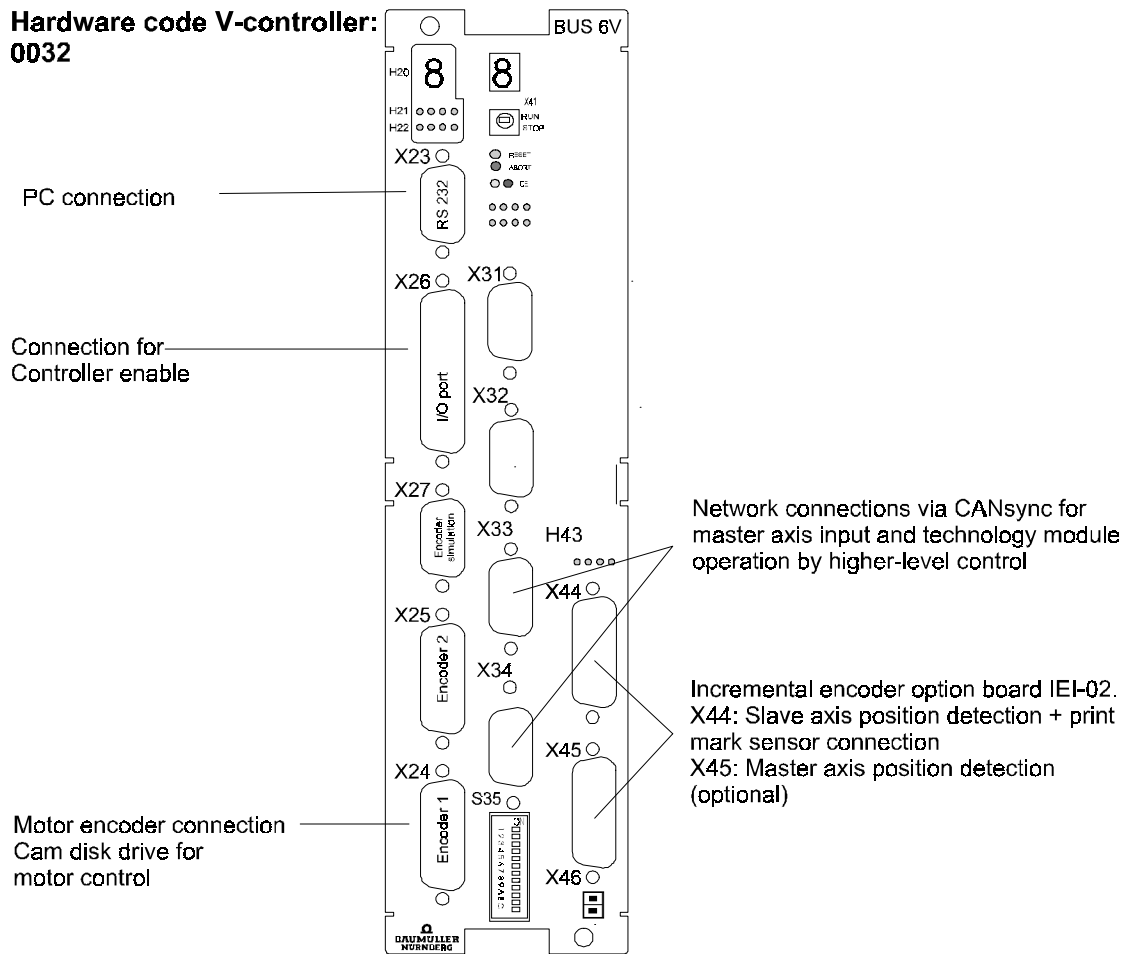

Fig: 6 V-controller, configuration 2

- Omega-DriveLine with incremental encoder option board IEI-02 for the setting of the master axis and use of the register control option and multi-function option board MFM-01 for the control of the technology module via the digital 24-Volt interface. The master axis can also be set via CANsync.

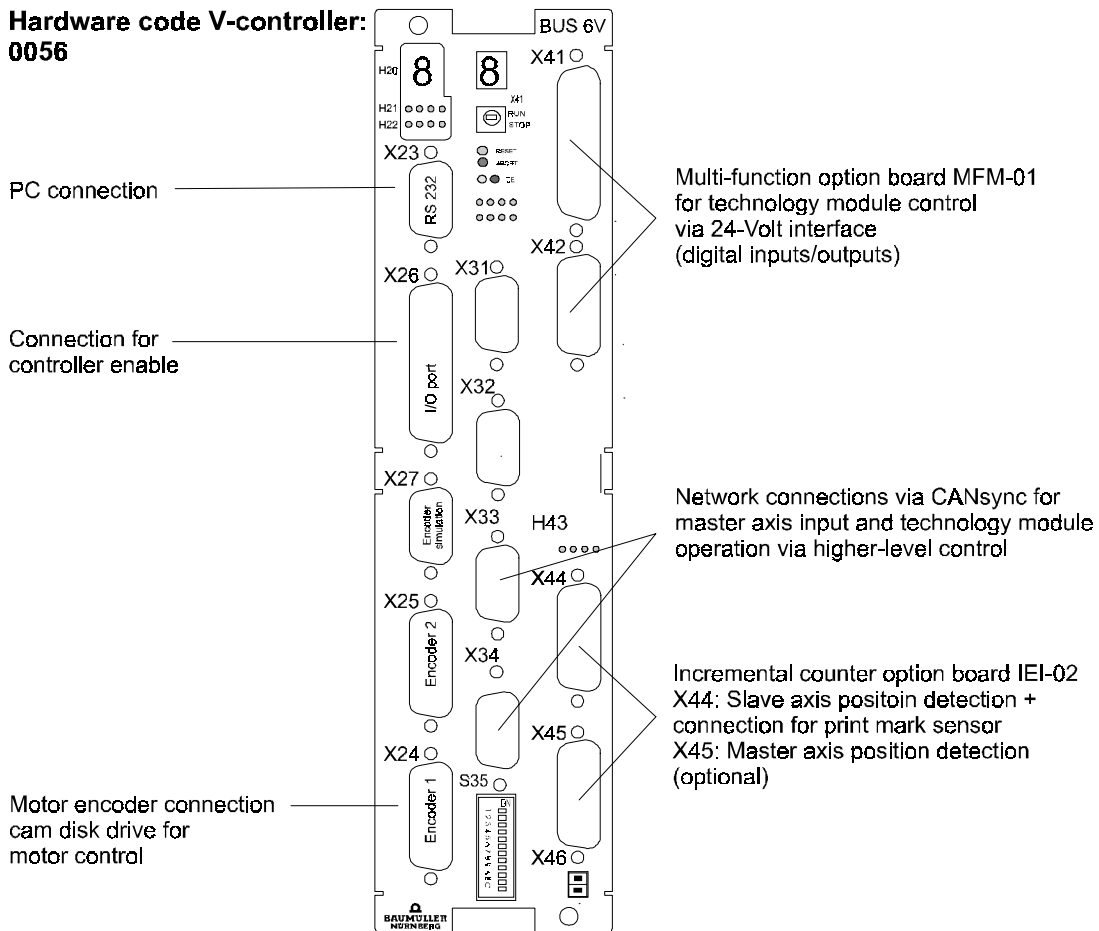

Fig: 7 V-controller, configuration 3

- Omega-DriveLine with multi-function option board MFM-01 for the control of the technology module via the digital 24-Volt interface and the setting of the master axis via CANsync without using the register control option.

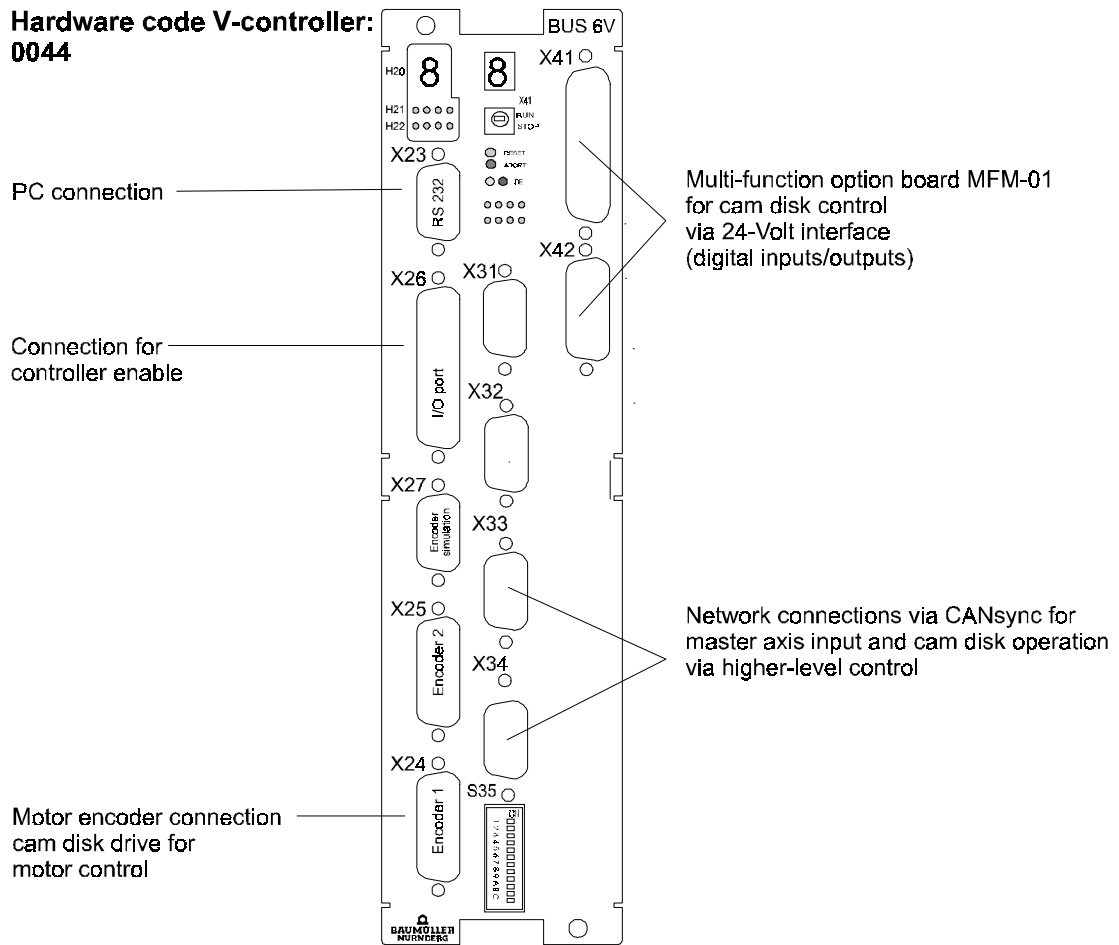

Fig: 8 V-controller, configuration 4

2.6 Commissioning instructions

You can call the technology module *Cam disk with register control option* via the menu option **Drive Mode>Technology Module**. The following window is an example; you can invoke the technology module Cam disk using every WinBASS window with a **Drive mode** menu option.

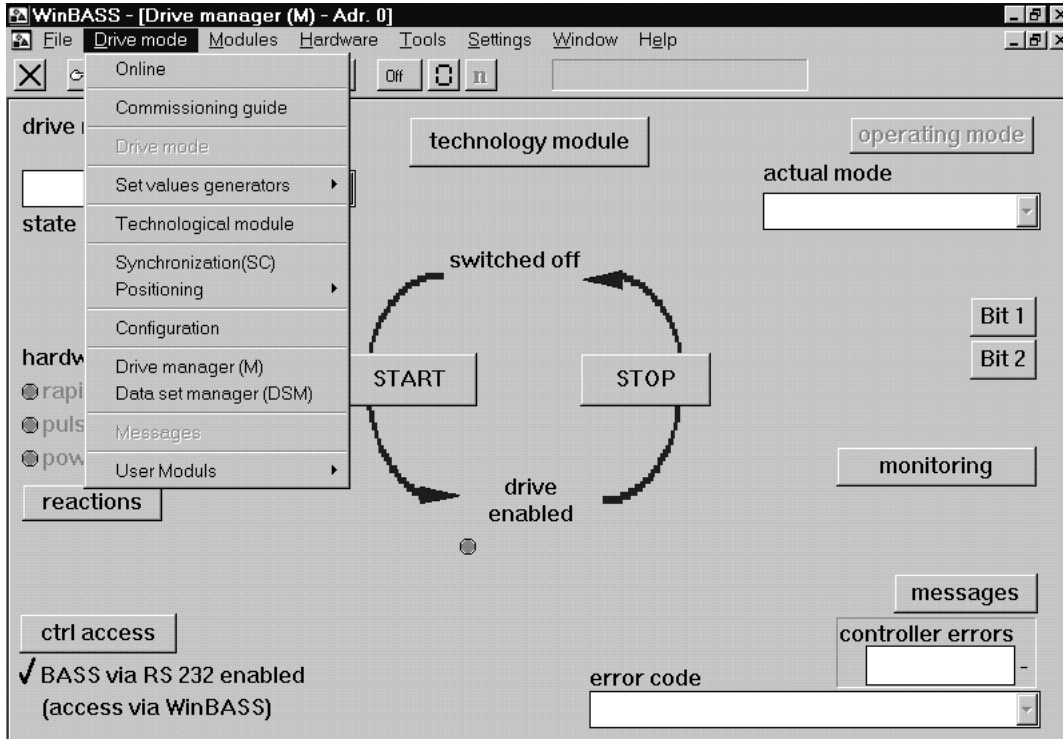

Fig: 9 Selection technology module from the main toolbar.



NOTE

Under WinBASS, select the operating mode **Synchronisation with synchronous setpoint input** for the drive. Activate the BAPS source under **Control access** in the **Drive manager** menu.

2.6.1 Determine the "online" mode



Fig: 10 Selection of online or offline parameterisation

In this window, you determine whether the PC and the **Omega** are online or offline. Select: **Offline** for the parameterisation with subsequent saving and **Online** for an up-/download to the **Omega-DriveLine**.

2.6.2 Selection of the technology module and specification of the version number

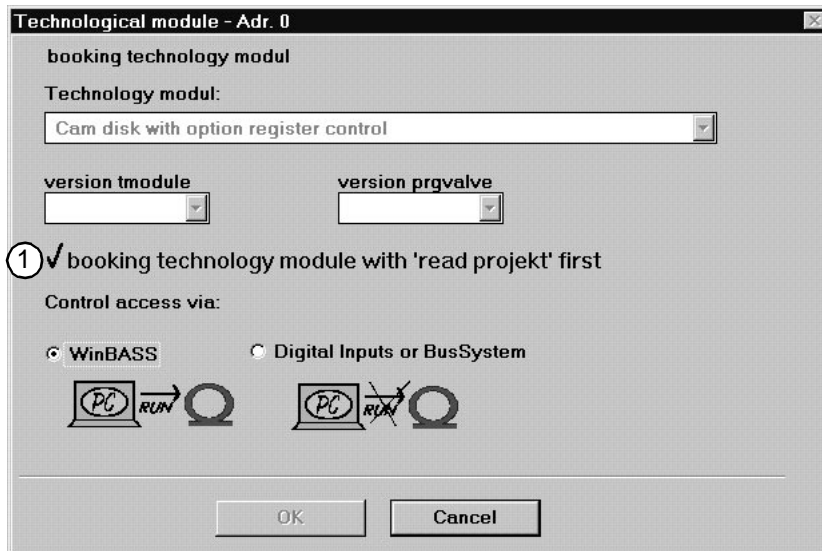

Fig: 11 Selection of technology module and control access

Offline mode

Select the desired technology module and enter the correct technology module version number and the higher-level program shell. WinBASS is already entered as the checking source.

Online mode

In the online mode, the technology module and the version numbers on the control are read. WinBASS or the digital inputs/outputs can be used as a checking source. If you click on ①, you can immediately start a parameterised project.



NOTE

Ensure that the V-controller is connected to the PC in the online mode. Determine the correct PC port COM1 ... COM4 under **Settings!**

2.6.3 Central user interface of the technology module

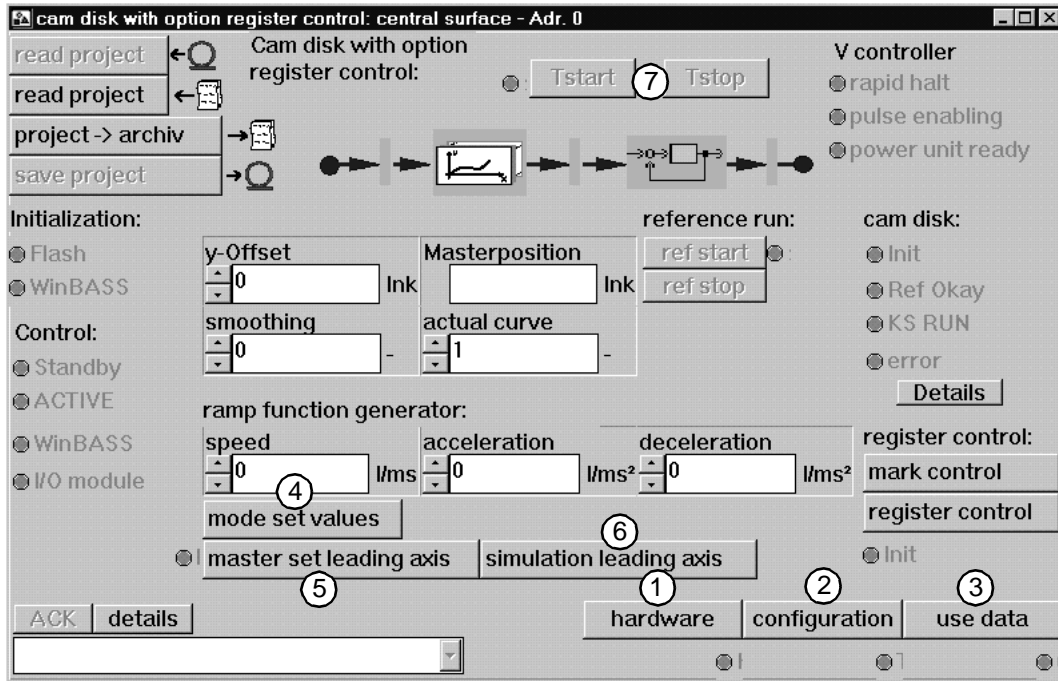

Fig: 12 Central user interface of the technology module cam disk with register control option

From the **central userinterface** window you can branch to other window in which you enter all settings required for commissioning. These 5 or 6 windows are:

- ① **Hardware** window on Page 21
- ② **Configuration** window on Page 22
- ③ **User data** window on Page 23
- ④ **Setpoint mode selection** window on Page 30
- ⑤ **Master axis setting angle** window on Page 31

or

- ⑥ **Master axis simulation** window on Page 31

Please edit the input windows which are required for commissioning in the sequence as stated above.

On the following pages you are guided through the commissioning. In the explanation of the windows we do not describe every item. Parameter settings which are necessary for experts only are also omitted. For a description of all parameters and displays refer to chapter "Windows and parameters" on page 51 ff.

After you have completed the entry of all data relevant for the commissioning, click on the ⑦ **TStart** or **TStop** button to start or stop the technology module *Cam disk with register control option*!

2.6.4 Hardware

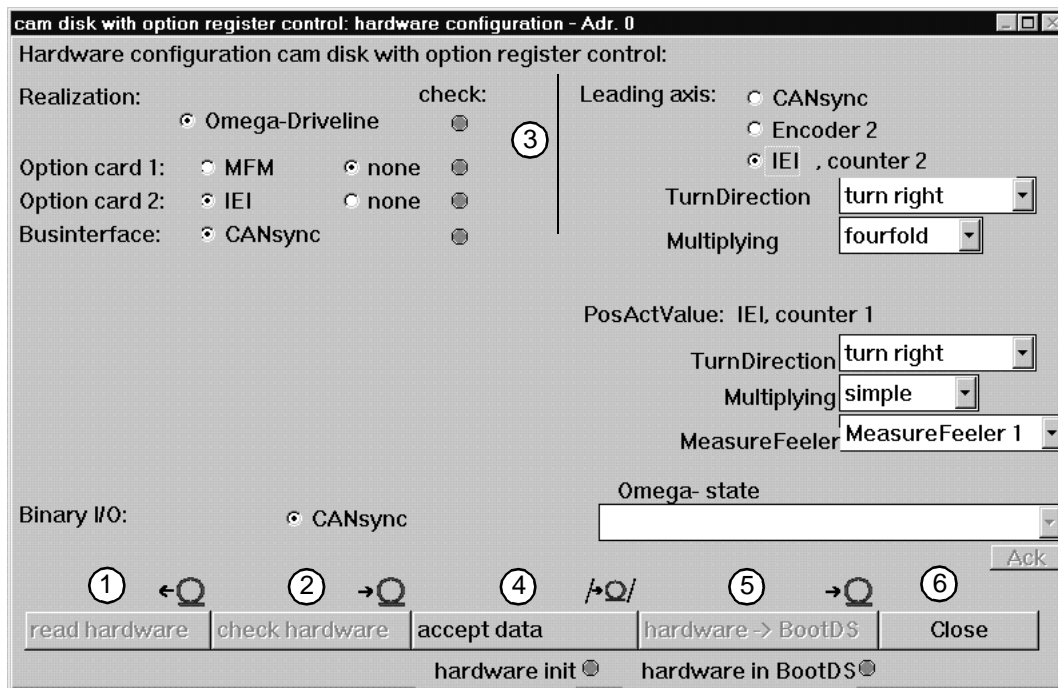

Fig: 13 Window for the hardware configuration

- ① First, read the current hardware configuration.
- ② Check the hardware to ensure that it can be initialised. If an error should occur, please refer to the error description and the remedy in chapter "Troubleshooting" on page 63 ff.
- ③ Then V-controller needs information how you want to provide the master axis value. The following options are possible:
 - CANsync fieldbus, see CANsync description.
 - Encoder input 2 of the V-controller, X25 connection.
 - IEI, counter 2, option board for the V-controller; remember to specify the direction of rotation and the multiplication of the signal evaluation of the IEI (see IEI description).

You can use the MFM board or the CANsync fieldbus for the digital inputs and outputs.

- ④ To save your data, click on the **Accept data** button (LED "illuminated" when accepted). This configures the hardware. The configuration data record is saved in the RAM. After a voltage cut-off the boot data record is used!
- ⑤ Then click on **Hardware→BootDR** , if you want to save your data non-volatile. The current configuration data record is saved as boot data record (LED "illuminated" when successfully saved).
- ⑥ Close the current window.

2.6.5 Configuration

To configure the cam disk, use the **configuration submenu**.

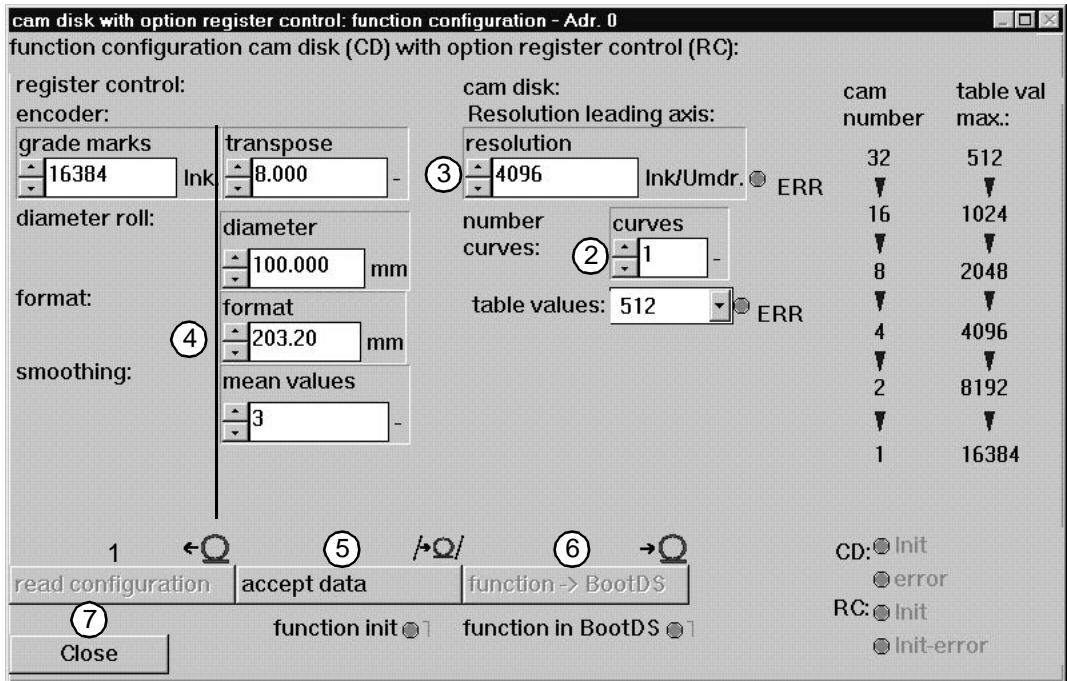

Fig: 14 Configuration of the technology module

- ① Reading the current configuration.
- ② Enter the number of your curves and the relevant number of interpolation points. Observe that you can save a maximum of 32 curves. The relevant number of interpolation points can be obtained from the right column. All saved curves must have the same length.
Default setting: Curve number: 1; Interpolation points 512.
- ③ Resolution of the master axis in increments/revolution. Up to 65535, all values are possible, after that only raise to the power of 2.
Default setting: 4096
- ④ This column is important only when using the register control option – if you use a cam disk only, do not edit this field!
- ⑤ To save your data, click on the **Accept data** button (LED "illuminated" when accepted). This configures the hardware. The configuration data record is saved in the RAM. After a voltage cut-off the boot data record is used!
- ⑥ Then click on **Hardware→BootDR** , if you want to save your data non-volatile. The current configuration data record is saved as boot data record (LED "illuminated" when successfully saved).
- ⑦ Close the current window.

2.6.6 User data

In this submenu, you can enter or modify the different curves.

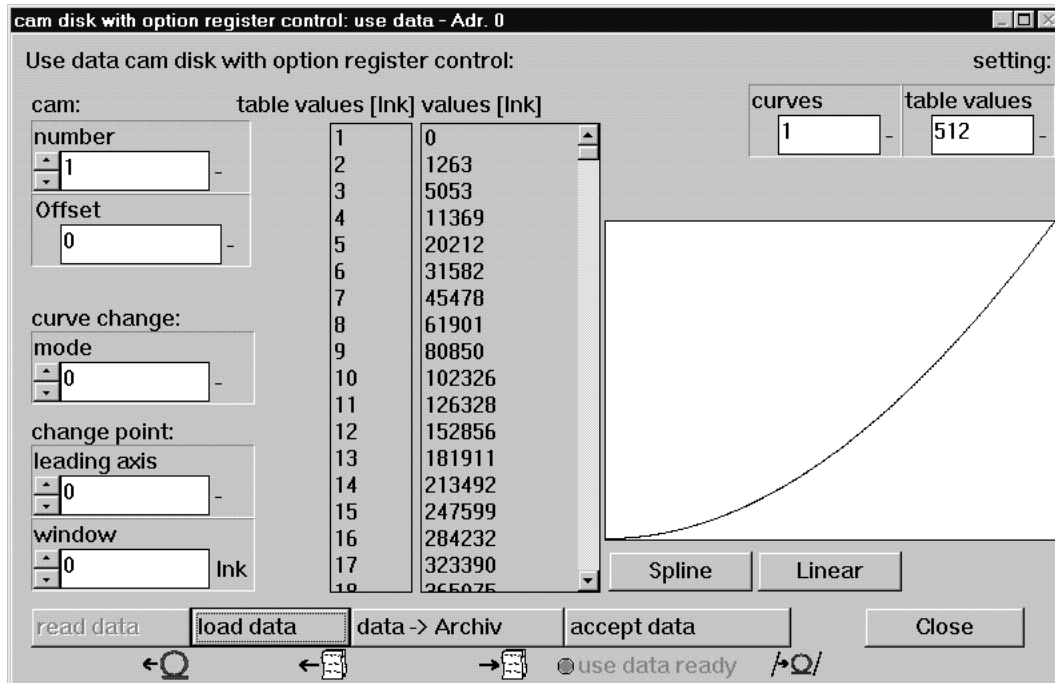

Fig: 15 User data of the cam disk



NOTE

If you should discover that you want to change the number of curves, you have to reconfigure the curves in the **Configuration** submenu!

You can create the curves in the following ways:

- Enter curve manually, doubleclick on the interpolation point to be changed (disadvantage: time-consuming, observe: 1 revolution = $2^{32}-1 = 4294967295$)
- Enter striking points and interpolate in a linear or "spline" function.
 - Linear:** First mark relevant interpolation points while the control key (Ctrl) is pressed, then click on the **Linear** button.
 - Spline:** First mark relevant interpolation points while the control key (Ctrl) is pressed, then click on the **Spline** button.

- Create curve data in a spreadsheet program and save as *Name.txt*. Then rename the file in the Explorer as *Name.ttm*. Open the file in a Windows editor and add five rows at the beginning, four times zero and in the fifth row the length of the curve table, i.e. the number of interpolation points! Save your settings. You can import the table in WinBASS using **Load file**.

```

Unbenannt - Editor
Datei Bearbeiten Suchen ?
0
0
0
0
1024
1
13
145
    
```

Fig: 16 Name.ttm

You have created the curves in a spreadsheet program, the program calculates the curve offset automatically. Please observe: After editing, save every curve using **Accept data** in the **Omega-DriveLine** and using **Data**→**Archive** on the hard disk!

The curve representation is scaled on the settings, i.e. the window size does not display a complete revolution of the cam disk (unless you have entered the interpolation point $2^{32} \cdot 2 - 1 = 4294967295$ but the maximum value which you have entered)!

You can change-over between your curves. Define the type of curve change-over under **Mode**, and the change-over point under **Master axis**. The following graphics show the possible variants. The change-over range (**window**) on the master axis is specified depending on the direction of rotation.

Mode 0: Positive (negative) direction of rotation

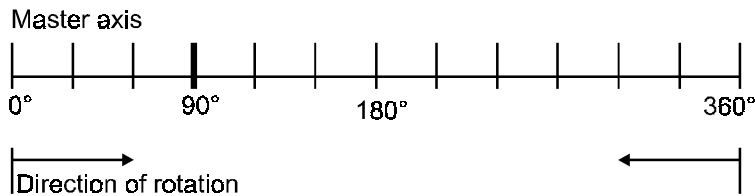

Fig: 17 Change-over range, mode 0

This mode means that the curves can be changed-over as from the master axis value.

Mode 1: Positive (negative) direction of rotation

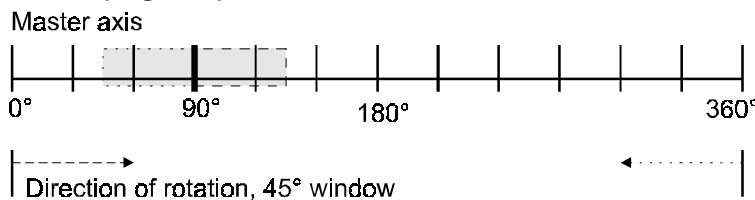

Fig: 18 Change-over range, mode 1

A change-over is possible in the range of 90° master axis +45° window with positive direction of rotation, and in the range 90° master axis -45° window with negative direction of rotation.

Mode 2: Change-over range is independent of the direction of rotation

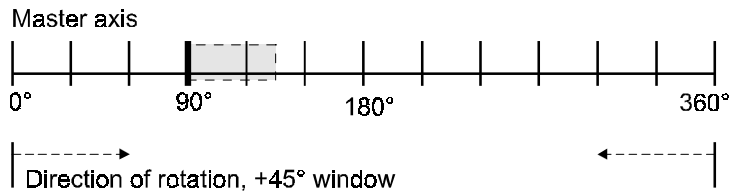

Fig: 19 Change-over range, mode 2

Change-over is possible in both directions of rotation between 90° ...90°+45°.

Mode 3: Change-over range is independent of the direction of rotation

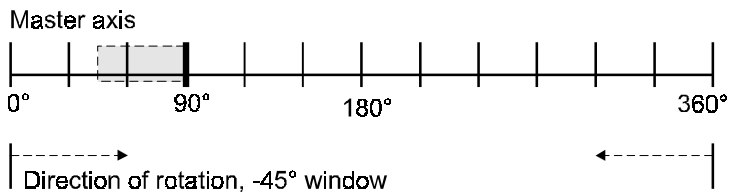

Fig: 20 Change-over range, mode 3

Change-over is possible in both directions of rotation between 90° ...90°-45°.

Mode 4: Change-over range is independent of the direction of rotation and symmetrical

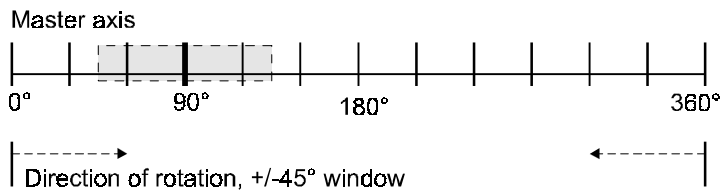

Fig: 21 Change-over range, mode 4

Change-over is possible in both directions of rotation within 90°-45° ...90°+45°.

Mode 5: Positive or negative change-over range, dependent on the direction of rotation

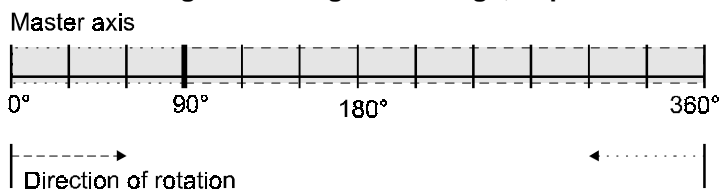

Fig: 22 Change-over range, mode 5

In positive direction of rotation, a change-over between 90° and 360°, in negative direction of rotation, a change-over between 90° and 0° is possible.

The window is specified in the same format as the master axis position. Mandatory for the master axis position: 0° to 360° correspond to 0 to 32768 digital. When you select a curve, the curve number must

be within the number of defined curves. If the selected mode is out of the defined modes, a change-over is not possible.



NOTE

To obtain a shockfree change-over, the curves must have the same inclination and table value in the change-over point. If a change-over is performed at a table transition $360^\circ \rightarrow 0^\circ$ or $0^\circ \rightarrow 360^\circ$ the offset of the previous curve is still used at this point.

Example:

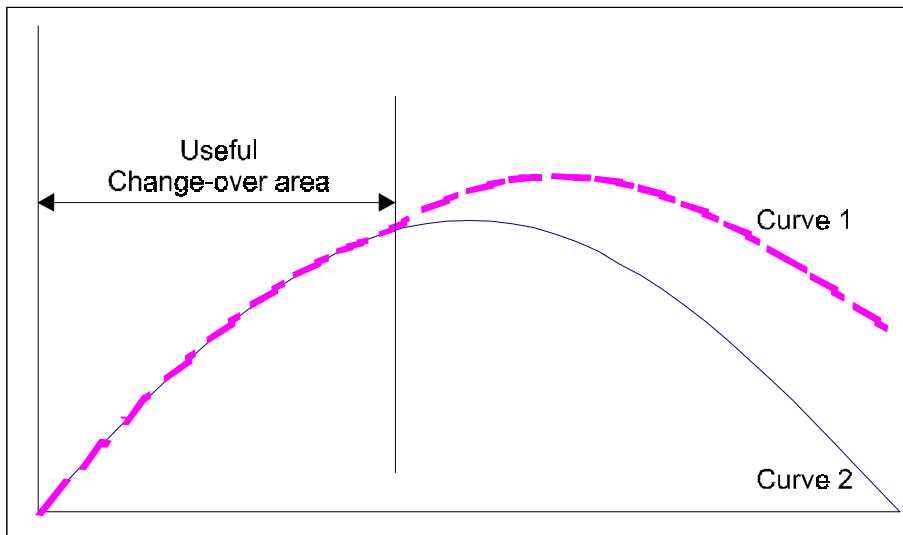

Fig: 23 Shockfree change-over

Example for the graphic representation of cam disks:

Let us assume that the following curves are given:

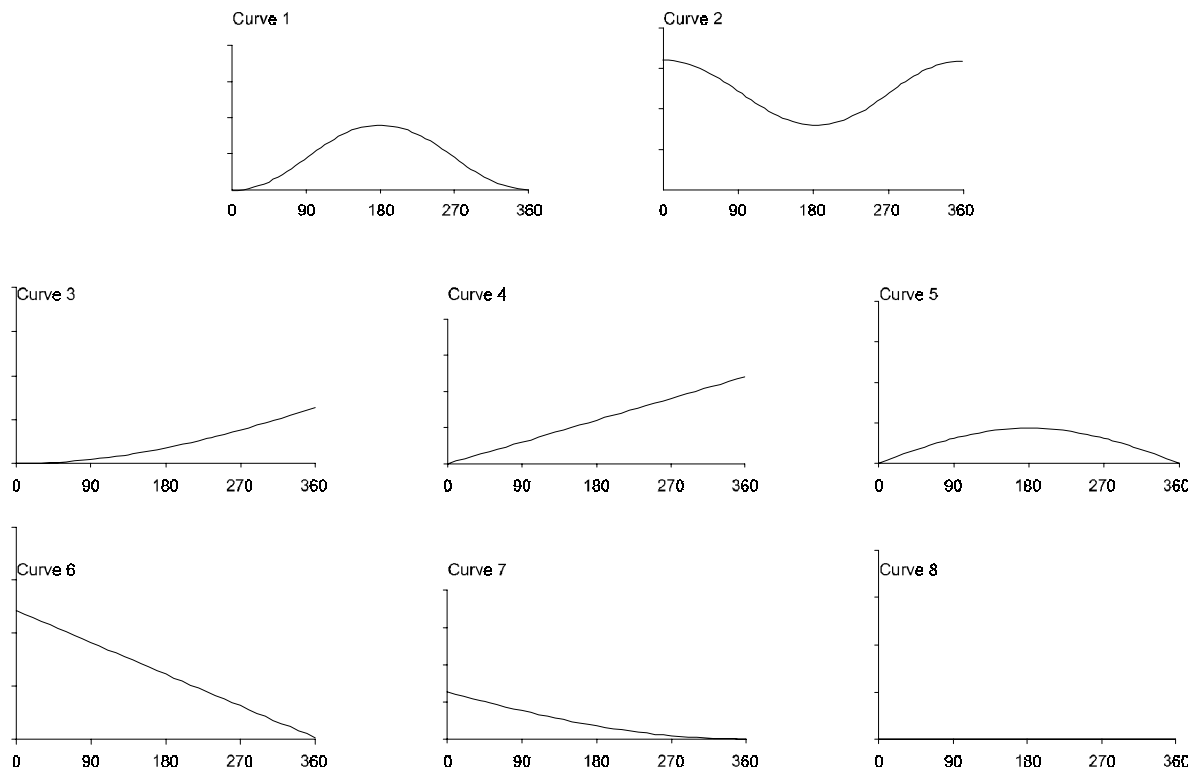

Fig: 24 Basic curves

Curve 1 and 2 merge continuously at 180°. Curve 3 and 4 have a positive offset, curve 6 and 7 have a negative offset.

Change-over within the curve

Invoking curves 1,2,1 results in the following shape after two revolutions with a curve change-over at 180°:

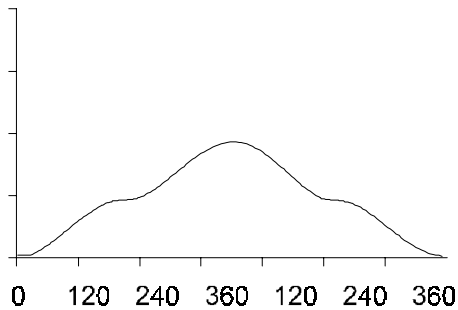

Fig: 25 Combination of basic curve 1,2,1

If the master position reaches 180° and curve 2 was selected, curve 2 is processed. The system returns to curve 1 only after 180° is reached again and curve 1 was selected.

Invoking curves 1,2,2,2,1 results in the following shape after four revolutions with a curve change-over at 180°:

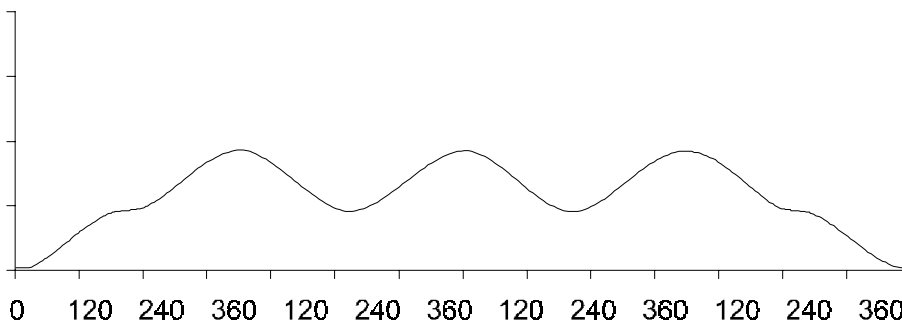

Fig: 26 Combination of basic curve 1,2,2,2,1

Change-over at the beginning or end of the curve

Invoking curves 3,4,5,6,7,8 results in the following shape with change-over at 0° from 3 to 4, from 4 to 5, at 359° from 5 to 6, from 6 to 7, from 7 to 8 and at 0° again from 8 to 3:

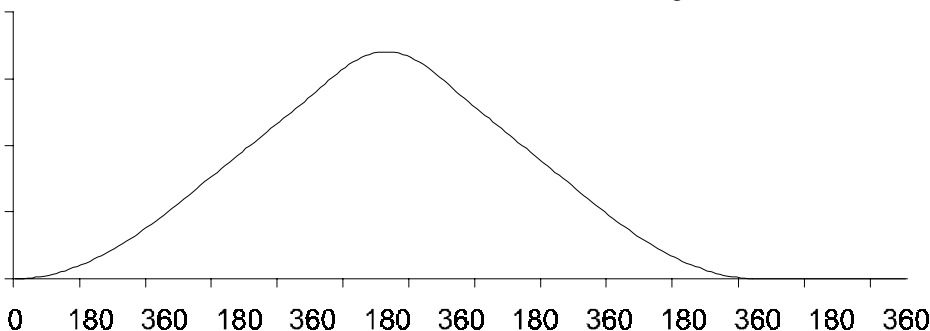

Fig: 27 Combination of basic curve 3,4,5,6,7,8

Change-over at the beginning of the curve and maintaining a curve with offset for several revolutions. Invoking curve 3,4,4 ff. results in the following shape with change-over from 3 to 4 at 0°:

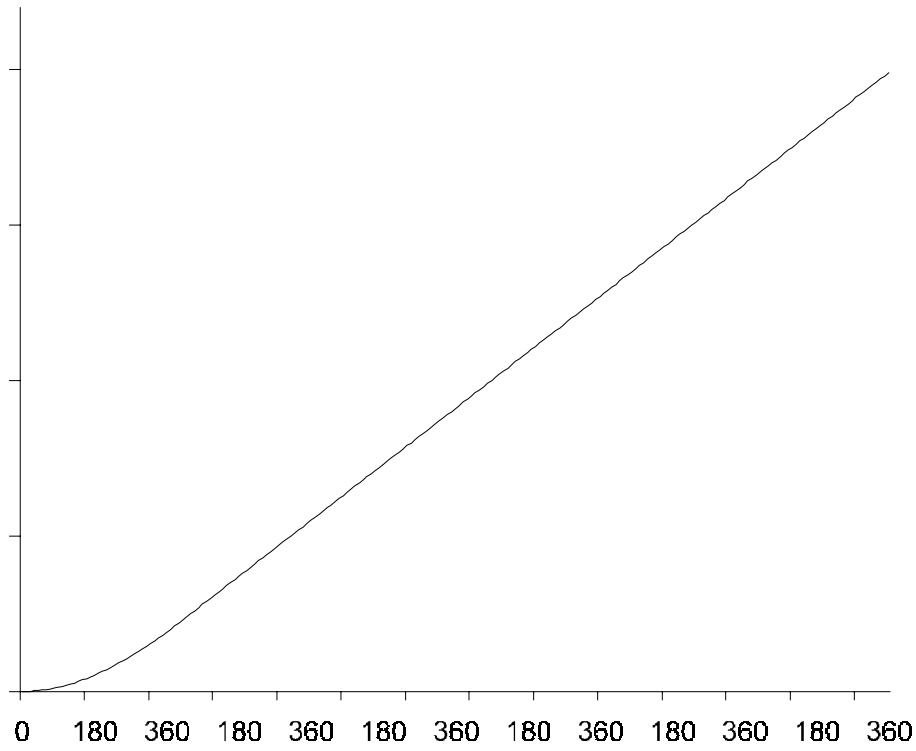

Fig: 28 Combination of basic curve 3,4,4

2.6.7 Setpoint mode selection

After selecting the relevant menu option, this window opens (see "Central user interface of the technology module" on page 20).

You can select among eight methods of how to process the cam disk function in the V-controller.

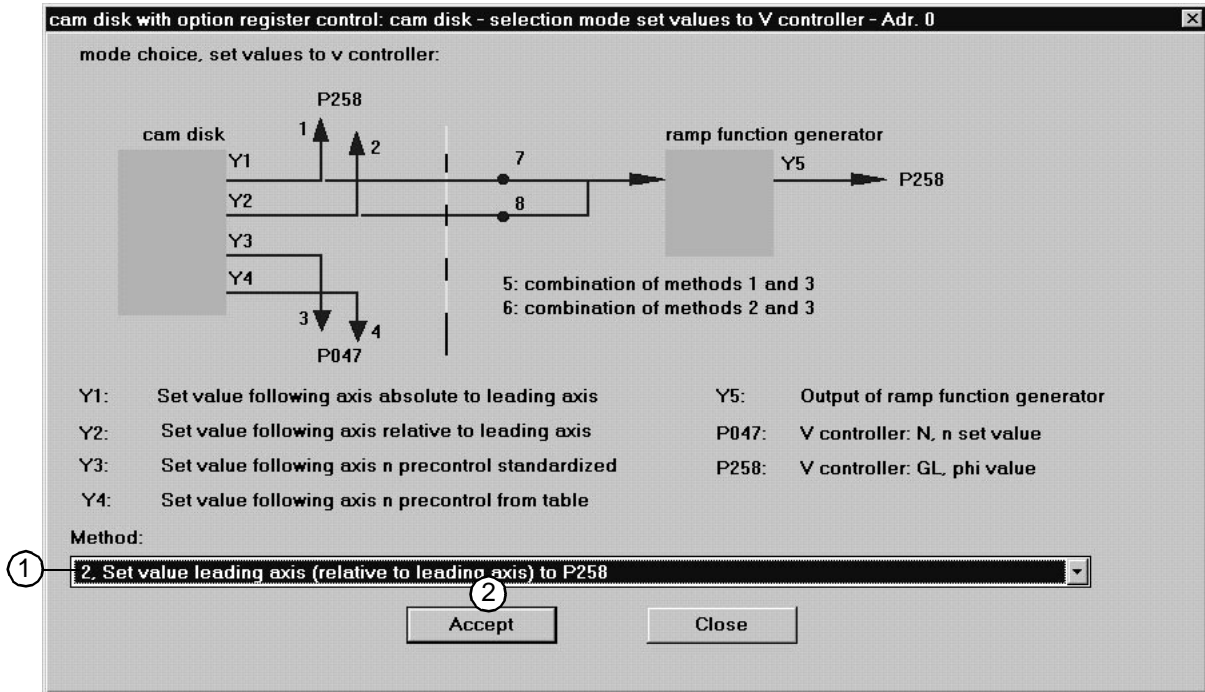

Fig: 29 Selection of the result of the cam disk function for the V-controller

- ① Method 1:
Absolute positioning of the slave axis to the master axis
 - Method 2:**
Relative positioning of the slave axis to the master axis, default setting
 - Method 3:
Slave axis setpoint with internal speed pilot control, scaled
 - Method 4:
Slave axis setpoint with internal speed pilot control, from table
 - Method 5:
Combination of methods 1 and 3
 - Method 6:
Combination of methods 2 and 3
 - Method 7:
Absolute positioning of the slave axis to the master axis using maximum conditions: speed, acceleration, deceleration (on the central user interface)
 - Method 8:
Relative positioning of the slave axis to the master axis using maximum conditions: speed, acceleration, deceleration (on the central user interface)
- ② Save your settings using **Accept**.

2.6.8 Master axis setting angle

After selecting the relevant menu option, this window opens (see "Central user interface of the technology module" on page 20). For the commissioning of the real master axis, the slave axis must be referred to the master axis.

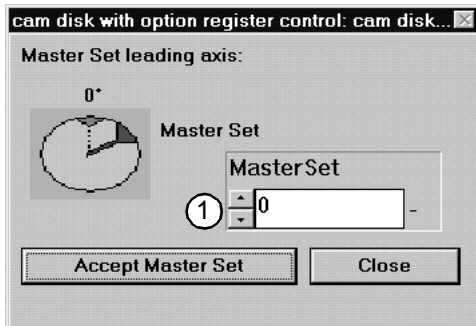

Fig: 30 Setting of the master position

- ① To create a reference between the slave axis and the master axis, enter the "setting angle" (angle between master and slave axis) [increments].

2.6.9 Master axis simulation

After selecting the relevant menu option, this window opens (see "Central user interface of the technology module" on page 20). For the commissioning with the **master axis simulation**, its settings must be entered:

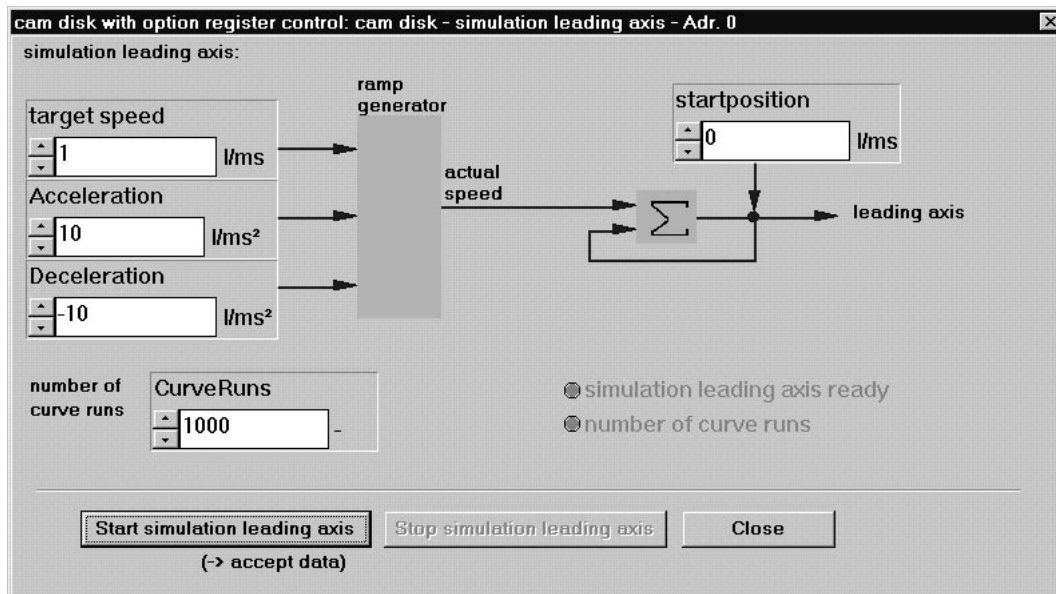

Fig: 31 Configuration and commissioning of the simulation "virtual master axis"

Before starting the master axis simulation, enter the speed, the maximum acceleration and the deceleration. The default setting for the start position is an offset of the master axis position, which is added to the master axis position. Add the curve sequences, then click on **Start master axis simulation**. Every parameter change will become effective only after you have clicked on **Start master axis simulation**!

Default values: Speed: 1 l/ms Acceleration: 10 l/ms²
 Deceleration: -10 l/ms² Curve sequences: 1000
 Start position: 0 Inc

2.7 Register control commissioning.

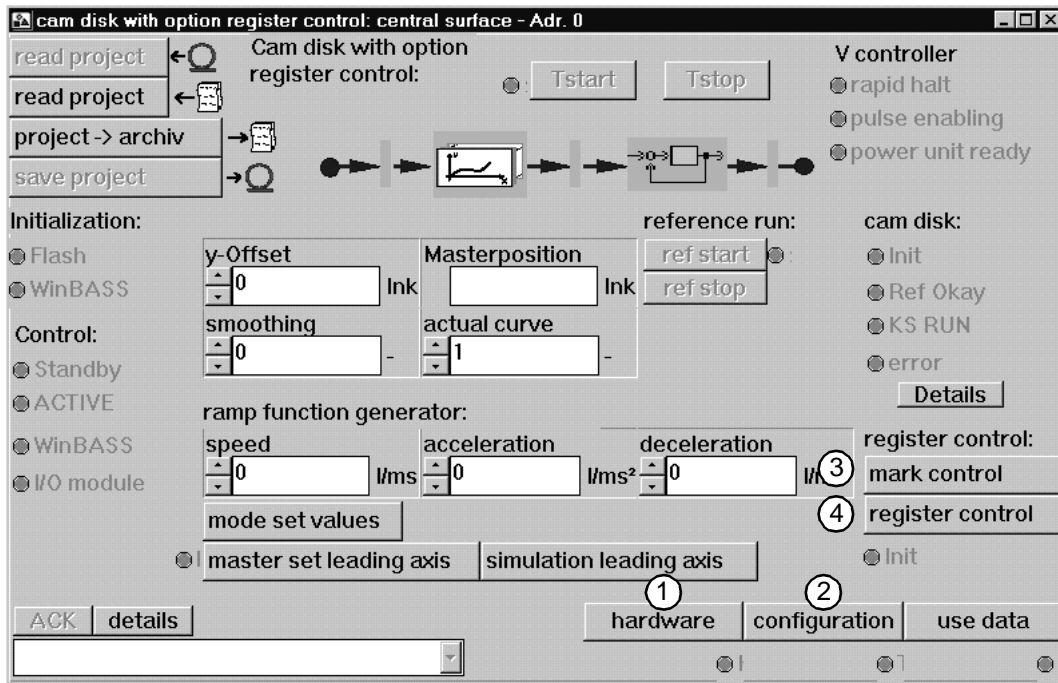

Fig: 32 Central user interface

From the **central user** interface window you can branch to other windows in which you enter all settings required for commissioning. These four windows are:

- ① **Hardware configuration** window
- ② **Function configuration** window
- ③ **Register control – mark check** window
- ④ **Register control – register controller** window

You can enter the settings required for commissioning the register control in the **central user interface** window. Please enter your settings in the sequence as stated above.



NOTE

Before starting the register control, you must have commissioned the cam disk!

2.7.1 Hardware setting

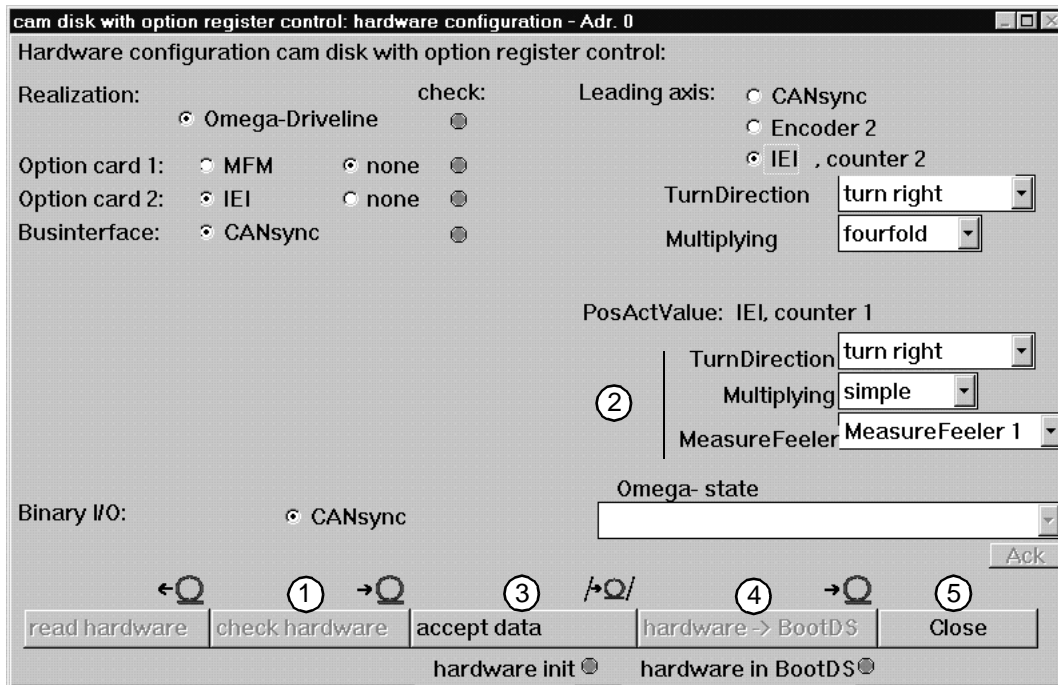

Fig: 33 Hardware configuration

- ① To check the required hardware components click on the **Check hardware** button. An "illuminated" LED shows that the IEI (incremental encoder interface) is functioning.
- ② Then perform the settings which are necessary for the register control.
 - Setting the direction of rotation: Default – clockwise rotation
 - Multiplication of the signal evaluation: Default - simple
 - Sensor connection: Default – sensor 1 at IEI for mark detection
- ③ To save your data, click on the **Accept data** button (LED "illuminated" when accepted). This configures the hardware. The configuration data record is saved in the RAM. After a voltage cut-off the boot data record is used!
- ④ Then click on **Hardware→BootDR** , if you want to save your data non-volatile. The current configuration data record is saved as boot data record (LED "illuminated" when successfully saved).
- ⑤ Close the current window.

2.7.2 Configuration

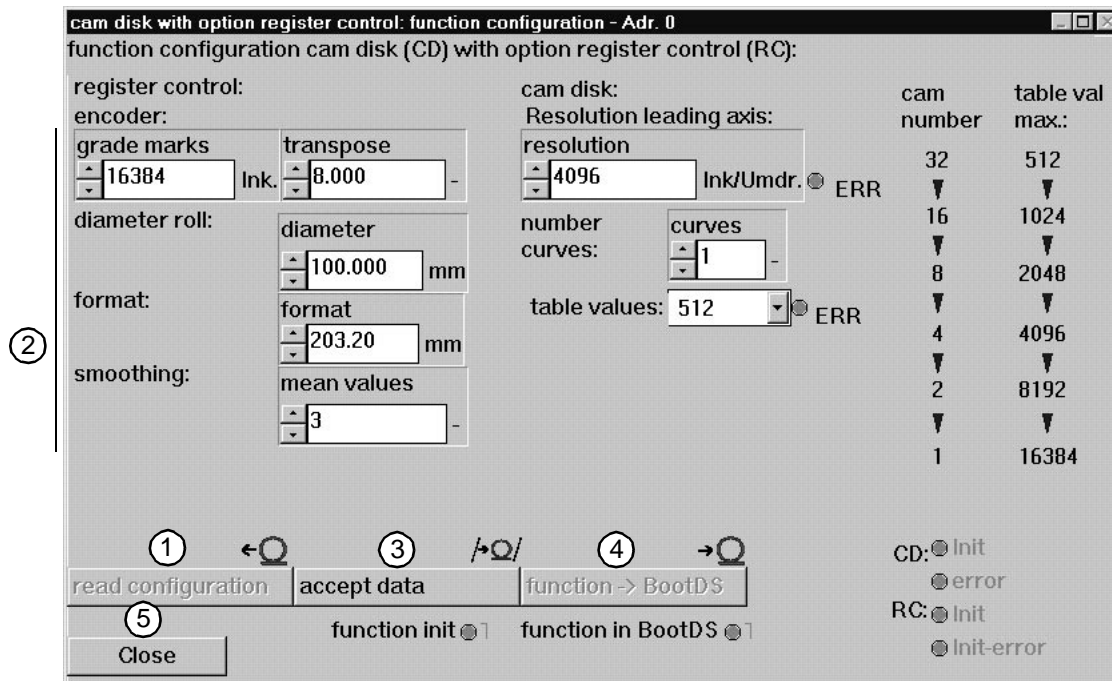

Fig: 34 Configuration of the technology module

The **function configuration** submenu is used to configure the register control.

- ① First, read the current hardware configuration.
- ② Set parameters:
 - **Increments:** Increments of the incremental encoder connected to the IEI counter 1.
 - **Ratio:** A possible gear can be considered using this entry, otherwise the default setting 1 applies.
 - **Diameter:** Enter the diameter of the format roll (working roll) which is mounted on the axle.
 - **Format:** Exact sheet length (see figure "Mode of functioning of the register control" on page 8), which corresponds to a period of the master axis or one curve sequence.
 - **Smoothing:** When the system operates in-register, the internal automatic setpoint generation is activated. The mark position maintaining the register is averaged using the specified amount of marks and provided as setpoint for the control. Default setting 3 means: 3 values read ⇒ averaging ⇒ new setpoint.
- ③ To save your data, click on the **Accept data** button (LED "illuminated" when accepted). This configures the hardware. The configuration data record is saved in the RAM. After a voltage cut-off the boot data record is used!
- ④ Then click on **Hardware→BootDR** , if you want to save your data non-volatile. The current configuration data record is saved as boot data record (LED "illuminated" when successfully saved).
- ⑤ Close the current window.

2.7.3 Register controller

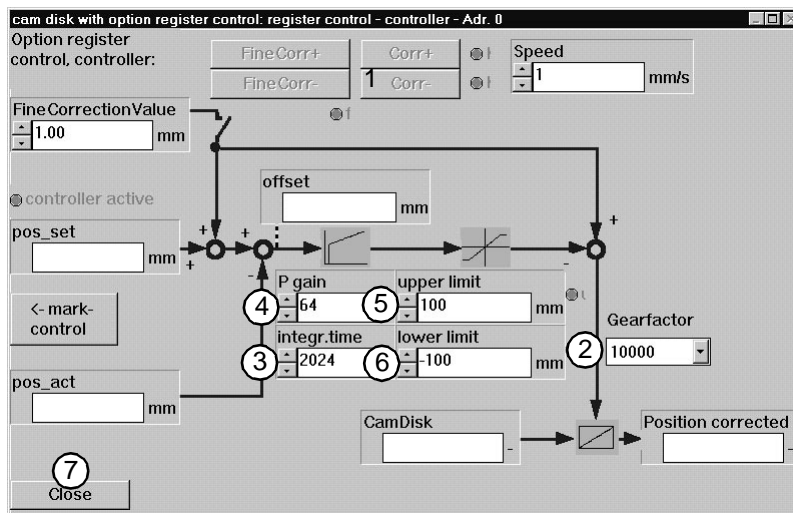

Fig: 35 Process overview of the register control

① **Case 1:** The cam disk is active, the **Setpoint active** checkbox in the **Register control – mark check** window is not selected. Use the position correction keys (**Corr+**, **Corr-**) to bring the object the position/movement of which is controlled, to the setpoint position. The processing station operates now in-register or maintains the register. After the controller has been activated, the register is maintained permanently (**mark check> S-Start**).

Case 2: The cam disk is active, the **Setpoint active** checkbox in the **Register control – mark check** window is selected. The value under **Setpoint input** in the **Register control – mark check** window is corrected automatically after **S-Start** has been activated.



NOTE

The **FineCorr+**, **FineCorr-** and the fine correction value are used to change the corrected setpoint any time.

Proceed as follows:

- ② Gear factor (default: 10000)
- ③ Integral-action time (default: 2048)
- ④ Gain (default: 64)
- ⑤ Upper limit (default: 100 mm)
- ⑥ Lower limit (default: -100 mm)

The register control can be operated using these settings. A complete commissioning, however, includes a final optimisation!

The gear factor ② can be reduced to obtain a fast correction, but this reduces the control accuracy.

- ⑦ Close the current window.

2.7.4 Mark check

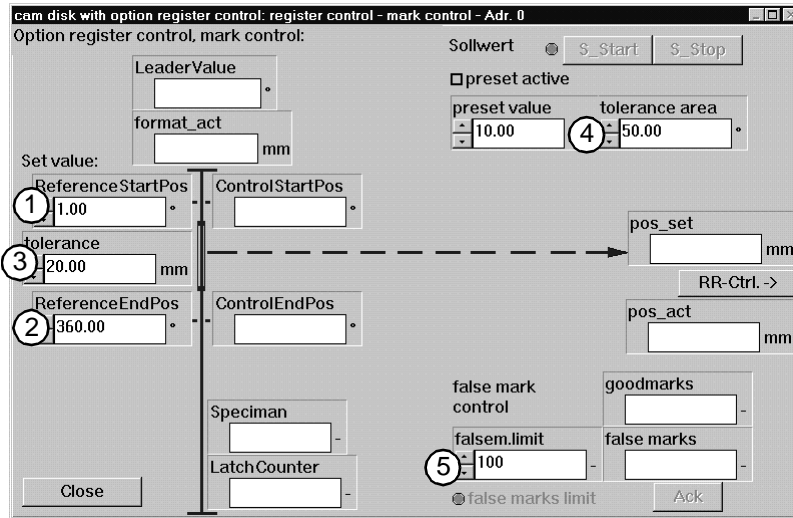

Fig: 36 Input of the tolerance range for the mark check

You can parameterise the mark check and setpoint input in this submenu. Set the parameters as follows:

- ① Reference start position: Setpoint filter start, when print mark $\leftrightarrow 0^\circ$
- ② Reference end position: Setpoint filter end, when print mark $\leftrightarrow 360^\circ$
- ③ Tolerance: Controller offset limitation around the mark which was corrected last [mm].
- ④ Tolerance range: Tolerance range around the setpoint for the automatic adjustment of the checking positions.
- ⑤ Check limit: Limit of the detected missing marks. When these marks are exceeded, an error message is displayed. Acknowledge using **Ack**, input >0

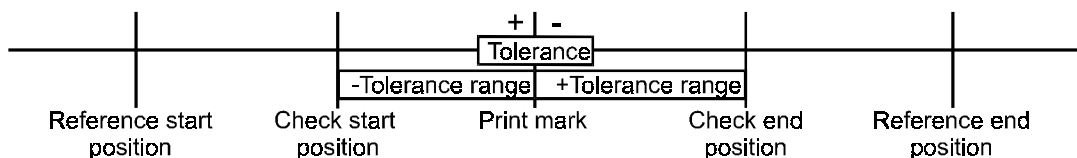

Fig: 37 Graphic of the tolerance range for the mark check

The parameters describe the reference interval for the automatic setpoint generation using the number of parameterised average values which were set in the configuration. It is started with **S_Start**, simultaneously with the setpoint detection.

The new setpoint is provided after n average values and the check limits **Check start position** and **Check end position** are set automatically using the parameterised **Tolerance range**. The position of the set check interval as well as the in the tolerance area of the mark last checked are the conditions for the acceptance of a new print mark.

If the **Setpoint input active** checkbox is selected, the values specified under **Setpoint input** is directly corrected after clicking on **S_Start**.

If the **Setpoint input active** checkbox is not selected, the **pos_set** is detected after clicking on **S_Start** as specified in the following example.

Example

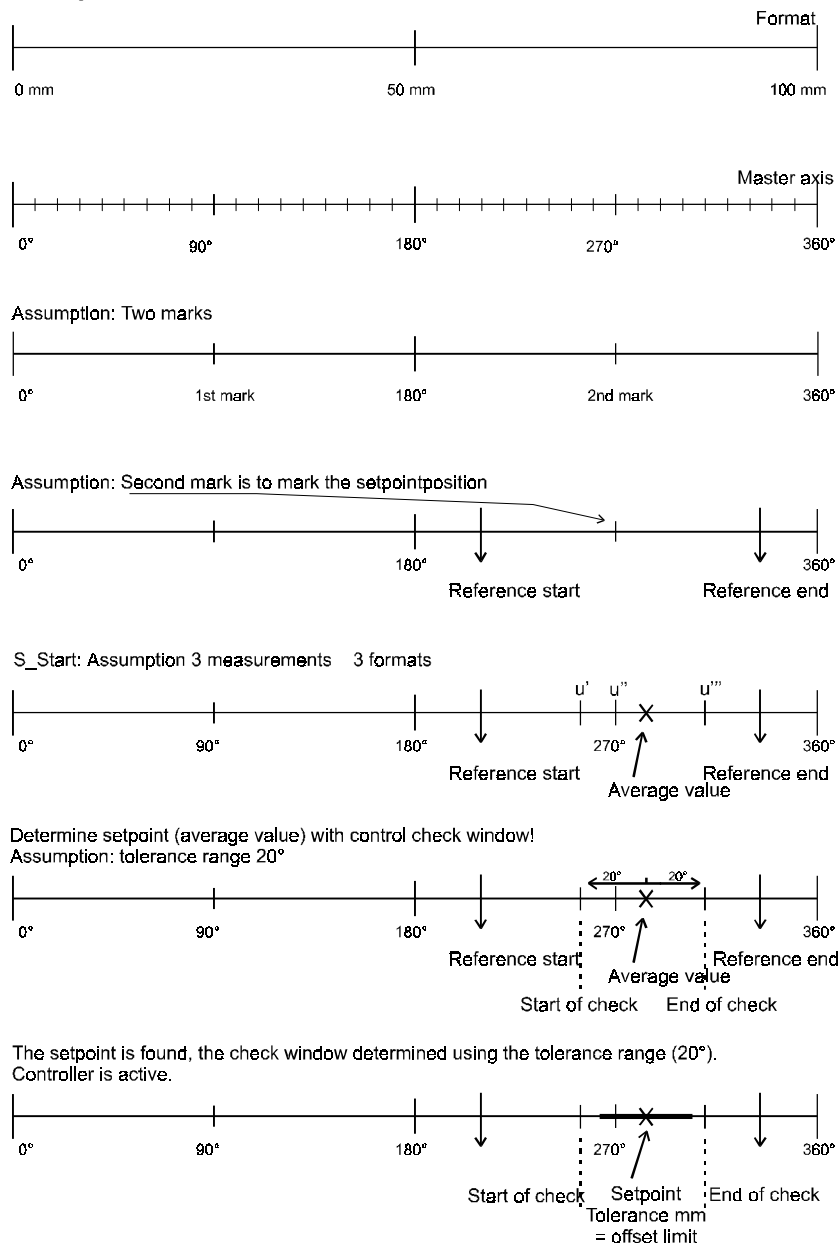

Fig: 38 Example of a register control for two print marks

Description of the example

Let us assume that the format length of the tools is 100 mm, this corresponds to one master axis revolution. Two marks are printed, and the correction refers to the second print mark. The reference start and end positions are parameterised to this range (e.g. 210° or 330°). The averaging is three; for the positions 260°, 270° and 310°, an average value of 280° results. The tolerance range determines the check start and end position and is defined with 20°. The tolerance [mm] determines the range around the print mark last detected. The tolerance acts as an offset limitation of the controller since only good marks are adjusted.



NOTE

Tolerance is used for the offset limitation and can be configured online. First enter a high value (e.g. 20 mm) to optimise the controller. Then adapt the value to the tool used (e.g. 5 mm).



NOTE

The optimisation of the register controller is mandatory!

The commissioning default settings are not suited to ensure the troublefree controller operation!

3 OPERATION

The drive/controller with the technology module *Cam disk with register control option* can be controlled in three different ways:

- Operation via WinBASS
WinBASS is used for commissioning, parameterisation, modification and monitoring of the drive.
- Control via digital 24 Volt interface.
The digital 24 Volt interface (I/O interface) is used to control the drive by means of digital pulses.
- Control via bus system
CANsync is available as a bus system. The bus system provides the master axis and the control bits to the drive/controller.

Setting the operating modes

The operating mode is set under WinBASS. After having connected the PC (COM1 ... COM4) to the controller (X23), start WinBASS and select the menu option **Technology module** under **Drive mode**.



NOTE

When you are in the Technology module under WinBASS and then make a connection to the drive or change to another drive, quit the Technology module and select again.

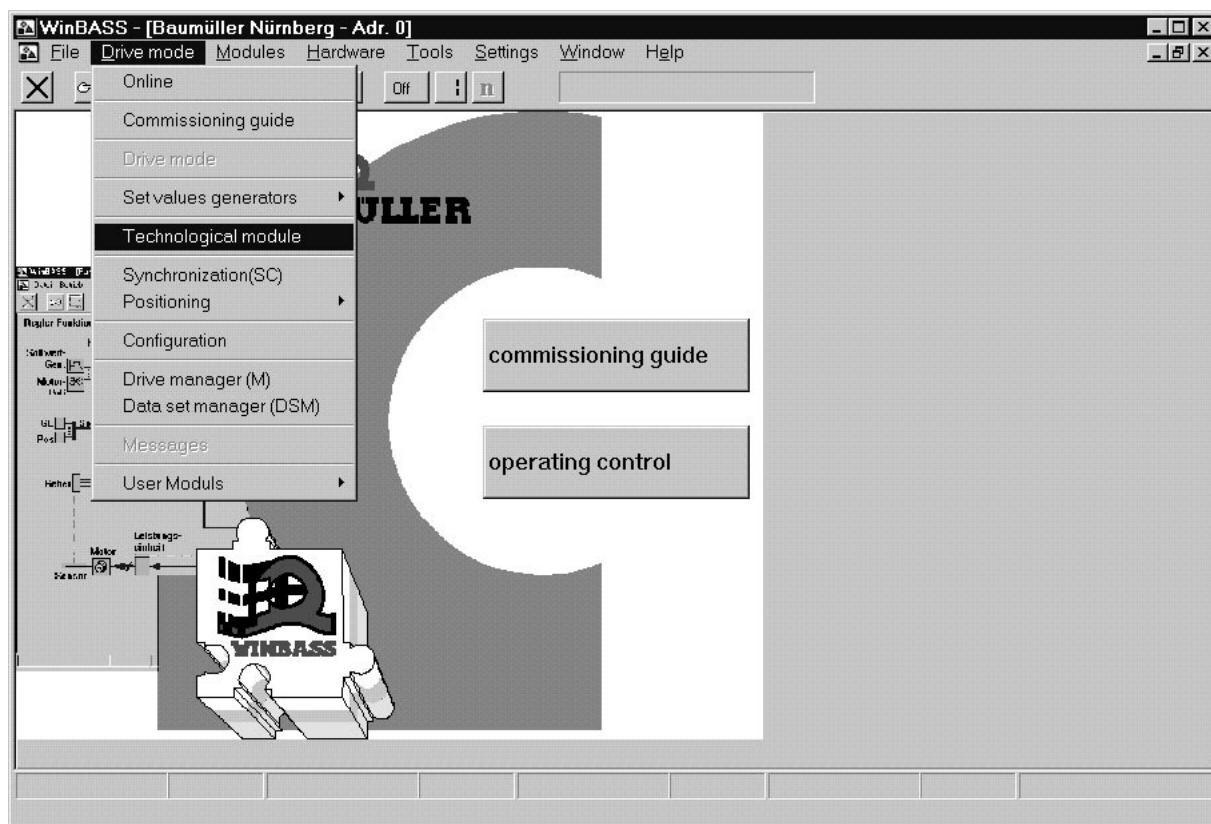

Fig: 39 Menu item "Technology module"

Select, whether you want to configure in the online or offline mode. In the online mode, the data is set directly to the controller/drive, in the offline mode, the settings are edited in the PC without controller/drive, and the controller/drive remains unchanged. You cannot toggle between the online and offline mode within the technology module.

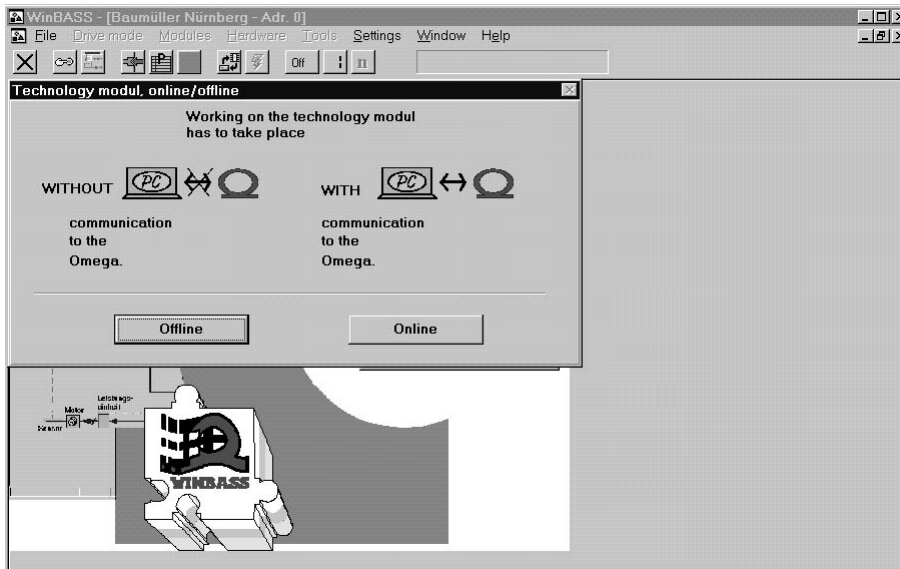

Fig: 40 Connection mode of the technology module

Under **Log in technology module** in the offline mode, you can select the **technology module** which you want to edit. In the online mode, the technology module of the controller/drive is selected. The control access determines the way of operating the technology module. You can select either drive control via **WinBASS** or **digital inputs or bus system**. The second item depends on whether the controller provides digital inputs (24-Volt interface) or the CANsync bus (Omega-DriveLine). In this case, you can watch the technology module via WinBASS.

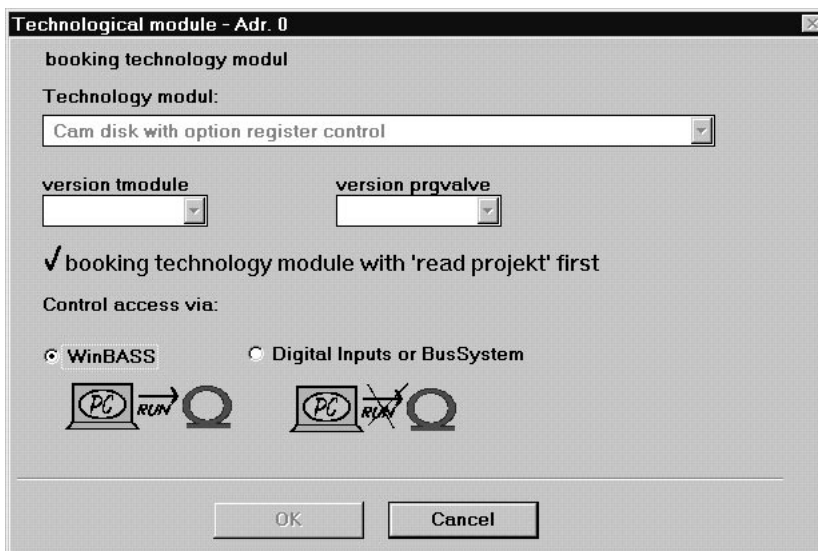

Fig: 41 Selection of technology module and control access

3.1 Operation via WinBASS

After you have selected **WinBASS** under **Log in technology module** (see figure **Selection of technology module and control access** on page 40) the central user interface is displayed

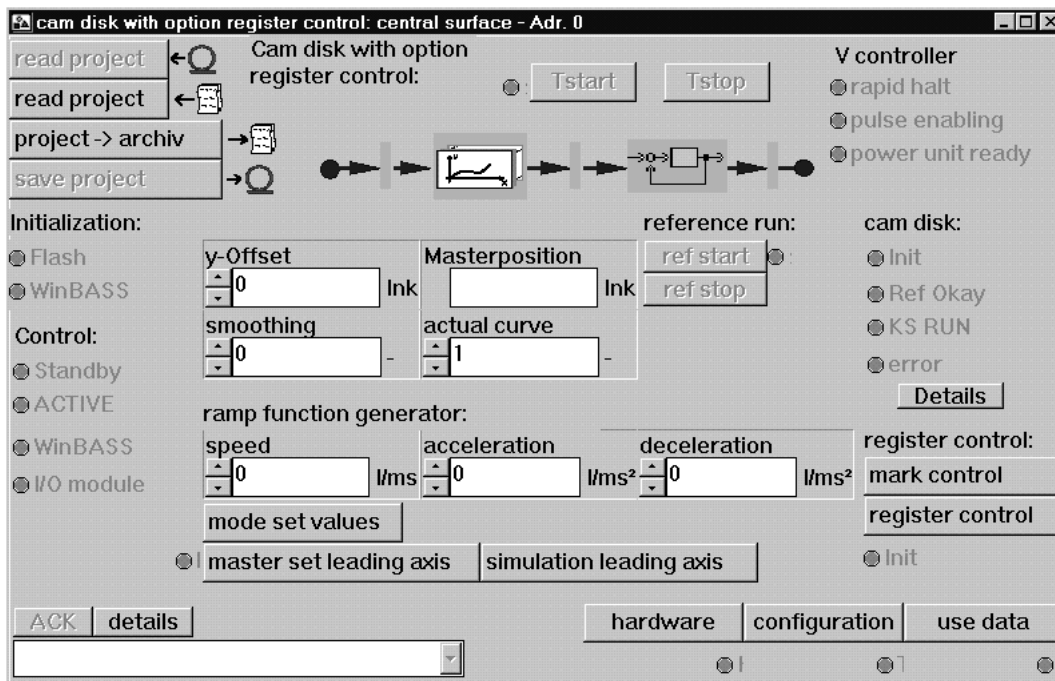

Fig: 42 Central user interface of the technology module cam disk with register control option



NOTE

For information for the initial commissioning please refer to **Commissioning** on page 7 ff.

The functions of the individual screens are described in Chapter **Windows and parameters** on page 51 ff.

3.2 Operation via 24-V interface MFM



NOTE

The functions of the individual screens are described in Chapter **Windows and parameters** on page 51 ff.

For the operation via the 24-V interface, the hardware **Omega-DriveLine + MFM-01** is required.

3.2.1 Input address assignment

| Connection X 41, PIN no. | Input no. | Meaning | |
|--------------------------|-----------|--|------------|
| 14 | 1 | Register control start [1] | Stop [0] |
| 15 | 2 | Fine + | Duration + |
| 16 | 3 | Fine - | Duration - |
| 17 | 4 | Technology module Start [1] / Stop [0] | |
| 18 | 5 | Homing of slave axis [1] / Stop [0] | |
| 19 | 6 | Accept master axis position [1] | |
| 20 | 7 | Curve number bit 0 | |
| 21 | 8 | Curve number bit 1 | |



NOTE

For connection assignment and grounding please refer to documentation MFM-01

Register control Start [1] / Stop [0]

If a high level (24 Volt) is applied to this input, the register control option is activated within the technology module, i.e. the setpoint is determined and used according to the selected mode.

Duration + / Fine +

When the register control is activated, one value (fine correction value) is added to the setpoint position with every positive flank 0 → 1. This value can be set in the technology module (see **Register control – controller window** on page 56). When the register control is deactivated, the phase position of the cam disk is shifted in positive direction, i.e. the tools is moved to its setpoint position for the time of the high state 1.

Duration - / Fine -

When the register control is activated, one value (fine correction value) is subtracted from the setpoint position with every positive flank 0 →1. This value can be set in the technology module (see **Register control – controller window** on page 56). When the register control is deactivated, the phase position of the cam disk is shifted in negative direction, i.e. the tools is moved to its setpoint position for the time of the high state 1.

Technology module Start [1] / Stop [0]

When a high level (24 Volt) is applied to this input, the technology module is started. The drive follows the master drive according to the settings.

Homing of slave axis [1] / Stop [0]

The homing of the drive is started. Homing is performed according to the settings in the V-controller (see documentation "Technology modules positioning and synchronisation V-controller" 5.96187.xx).

After the output has indicated **Homing done**, homing is completed by setting the input **homing slave axis** to a low level.

Master axis setting angle [1]

When a high level is applied, the setting angle for the master axis is accepted. The connected master axis is evaluated.

Curve number bit 0 and bit 1

These inputs are used to select the current number of cam disks which were configured under WinBASS. The curve number is binary coded.

| Level input 7 | Level input 8 | selected curve |
|---------------|---------------|----------------|
| 0 | 0 | 1 |
| 1 | 0 | 2 |
| 0 | 1 | 3 |
| 1 | 1 | 4 |

3.2.2 Output address assignment

| Connection X 41, PIN no. | Output, no. | Meaning |
|--------------------------|-------------|--|
| 1 | 1 | Setpoint found register control active [1] |
| 2 | 2 | Limit of missing marks reached [1] |
| 3 | 3 | Technology module initialised [1] |
| 4 | 4 | Cam disk data is ready [1] |
| 5 | 5 | Homing done [1] |
| 6 | 6 | Cam disk active [1] |
| 7 | 7 | Error [1] |
| 8 | 8 | Setting angle accepted |



NOTE

For connection assignment and grounding please refer to documentation MFM-01

Setpoint found register control active [1]

A high level is applied to the output when the register control was activated within the technology module and a setpoint is provided.

Limit of missing marks reached [1]

A high level is applied to the output when the limit of missing marks within the register control is reached and the control was stopped.

Technology module initialised [1]

A high level is set to the output when the initialising phase within the technology module is completed.

User data is ready [1]

A high level is applied to the output when all user data within the technology module are correctly provided.

Homing done [1]

A high level is applied to the output when the homing of the drive was completed successfully.

Cam disk active [1]

A high level is applied to the output when the drive moves according to the settings. The technology module is active.

Error [1]

A high level is set to the output when an error occurs within the technology module.

Setting angle accepted [1]

A high level is applied to the output when the master axis value was accepted.

3.3 Operation via CANsync bus

The following control and status words are available for the operation of the technology module via CANsync.

3.3.1 Assignment of the control word

| Control word bit | Meaning |
|------------------|--|
| 0 | Register control Start [1] / Stop [0] |
| 1 | Duration + |
| 2 | Duration - |
| 3 | Technology module Start [1] / Stop [0] |
| 4 | Homing of slave axis [1] / Stop [0] |
| 5 | Accept master axis position [1] |
| 6 | Curve number bit 0 |
| 7 | Curve number bit 1 |
| 8 | Curve number bit 2 |
| 9 | Curve number bit 3 |
| 10 | Curve number bit 4 |
| 11 | Curve number bit 5 |
| 12 | reserved |
| 13 - 15 | reserved |
| 16 | Fine + |
| 17 | Fine - |
| 18 | Ack missing marks |
| 19 | Setpoint input active |
| 20 - 31 | reserved |

Register control Start [1] / Stop [0]

When this bit is set, the register control option is activated within the technology module, i.e. the setpoint is determined and used according to the selected mode.

Duration +

For the time during which the bit is set, the phase position of the cam disk is shifted in positive direction, i.e. the tool is moved to its setpoint position.

Duration -

For the time during which the bit is set, the phase position of the cam disk is shifted in negative direction, i.e. the tool is moved to its setpoint position.

Technology module Start [1] / Stop [0]

When this bit is set, the technology module is started. The drive follows the master drive according to the settings.

Homing of slave axis [1] / Stop [0]

The homing of the drive is started. Homing is performed according to the settings in the V-controller (see documentation "Technology modules positioning and synchronisation V-controller" 5.96187.xx).

After the output has indicated **Homing done**, the homing is completed by resetting the bit to 0.

Master axis setting angle [1]

When the bit changes from 1 to 0, the setting angle for the master axis is accepted. The connected master axis is evaluated.

Curve number bit 0 to bit 5

These bits are used to select the current number of cam disks which were configured under WinBASS. The curve number is binary coded.

| Bit 0 | Bit 1 | Bit 2 | Bit 3 | Bit 4 | Bit 5 | selected table |
|-------|-------|-------|-------|-------|-------|----------------|
| 0 | 0 | 0 | 0 | 0 | 0 | 1 |
| 1 | 0 | 0 | 0 | 0 | 0 | 2 |
| 0 | 1 | 0 | 0 | 0 | 0 | 3 |
| ... | ... | ... | ... | ... | ... | ... |
| 1 | 1 | 1 | 1 | 1 | 1 | 32 |

Fine +

When the register control is activated, one value to be set in the technology module is added to the offset of the calculated setpoint position with every positive change 0 → 1.

Fine -

When the register control is activated, one value to be set in the technology module is subtracted from the offset of the calculated setpoint position with every positive change 0 → 1.

Ack missing marks

The register control counter for missing marks is cleared when this bit is set. The counter is reset and the system uses the old setpoint again as long as the bit is set.

Setpoint input active

If you activate this checkbox, the setpoint input is corrected automatically. If you deactivate this checkbox, the setpoint position (from the configured number of incoming print marks) is determined using the homing window.

3.3.2 Assignment of the status word

| Status word bit | Meaning |
|-----------------|--|
| 0 | Setpoint found register control active [1] |
| 1 | Limit of missing marks reached [1] |
| 2 | Technology module initialised [1] |
| 3 | Cam disk data is ready [1] |
| 4 | Homing done [1] |
| 5 | Cam disk active [1] |
| 6 | Error [1] |
| 7 | Setting angle accepted |
| 8-11 | reserved |
| 12 | Cam disk initialising error |
| 13 | Slave axis resolution error |
| 14 | Error curve number = 0 |
| 15 | reserved |
| 16 | reserved |
| 17 -18 | reserved |
| 19 | Upper limit of register control |
| 20 | Lower limit of register control |
| 21 | reserved |
| 22 | Fine correction set |
| 23 | reserved |
| 24 | Register control initialisation OK |
| 25 | Register control initialisation error |
| 26 -31 | reserved |

Setpoint found register control active [1]

The bit is set to 1, when the register control within the technology module was activated and a setpoint is provided.

Limit of missing marks reached [1]

The bit is set to 1 when the limit of missing marks within the register control is reached and the control was stopped.

Technology module initialised [1]

The bit is set to 1 when the initialisation phase within the technology module is completed, i.e. when cam disk and register control are initialised.

User data ready [1]

The bit is set to 1 when all user data within the technology module are correctly provided.

Homing done [1]

The bit is set to 1 when the homing of the drive was completed successfully.

Cam disk active [1]

The bit is set to 1 when the drive moves according to the settings. The technology module is active.

Error [1]

The bit is set to 1 when an error occurs within the technology module.

Setting angle accepted [1]

The bit is set to 1 when the master axis value was accepted.

Cam disk initialising error

The bit is set when an error occurs during the cam disk initialisation. This can be caused by faulty inputs of configuration data.

Slave axis resolution error

The bit is set when the resolution value for the master axis entered in WinBASS is not valid. Valid values are 1 to 65535 and all raises to the power of 2, e.g. $2^{20}=1,048,576$.

Curve number = 0

This bit is set when the selected curve number of the cam disk is zero.

Upper limit of register control

This bit is set when the upper limit for the register control offset which has been configured under WinBASS is reached.

Lower limit of register control

This bit is set when the lower limit for the register control offset which has been configured under WinBASS is reached.

Fine correction set

This bit is set when the fine correction (Fine + / Fine -) is activated within the register control

Register control initialisation OK

This bit is set when the register control initialisation has been completed successfully.

Register control initialisation error

The bit is set when an error occurs during the register control initialisation.

4 WINDOWS AND PARAMETERS

4.1 Central user interface window

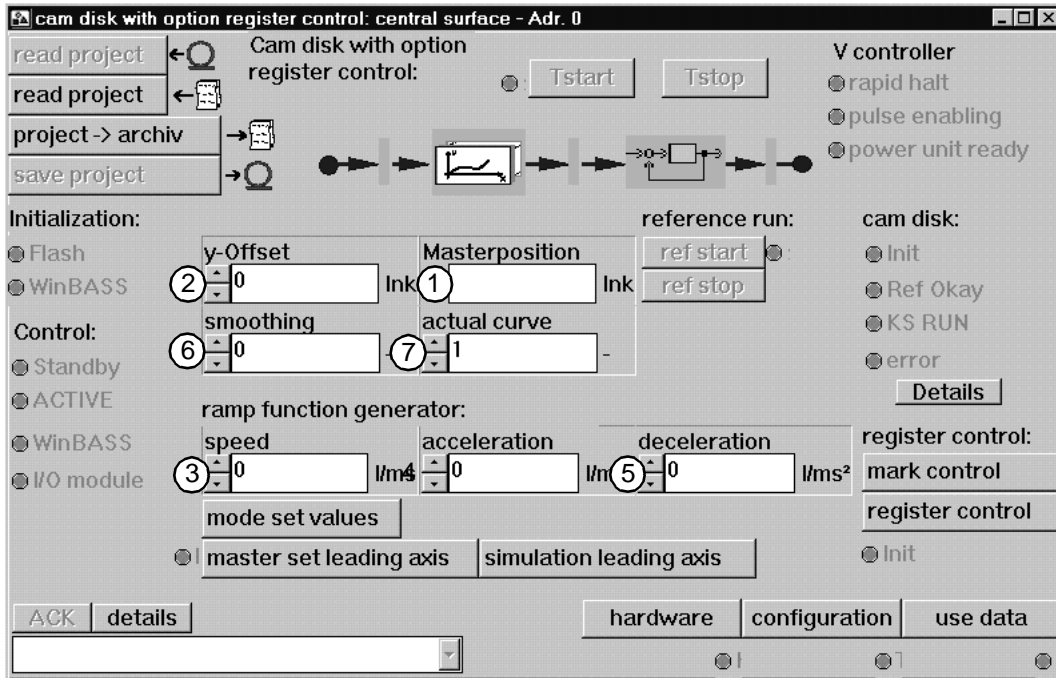

Fig: 43 Central user interface of the technology module cam disk with register control option

- ① Display of the master axis position. Input for the cam disk.
This parameter is used to check whether the master axis moves.
- ② You can shift the cam disk to the zero position in Y-direction using this parameter.
- ③ This parameter is used for the maximum speed limitation for the ramp function generation according to method 7 and 8 (see **Setpoint mode selection** on page 30).
- ④ This parameter is used for the maximum acceleration limitation for the ramp function generation according to method 7 and 8 (see **Setpoint mode selection** on page 30).
- ⑤ This parameter is used for the maximum deceleration limitation for the ramp function generation according to method 7 and 8 (see **Setpoint mode selection** on page 30).
- ⑥ Amount for the value smoothing of a real master axis.
The smoothing for the speed pilot control of the cam disk is the PT1 time constant which is scaled to the cycle time of the interrupt, that means without unit. For the conversion to a time-continuous PT1 applies the following:

$$T = 2^n \times 2\text{ms}$$

$$n = \text{input value for smoothing, } T = \text{PT1 time constant, } 2\text{ms} = \text{IRP time.}$$
- ⑦ Momentary curve number which is processed by the technology module. When a new curve number is entered while a curve is processed, the curve is changed over according to the mode entered in the **user data** window.

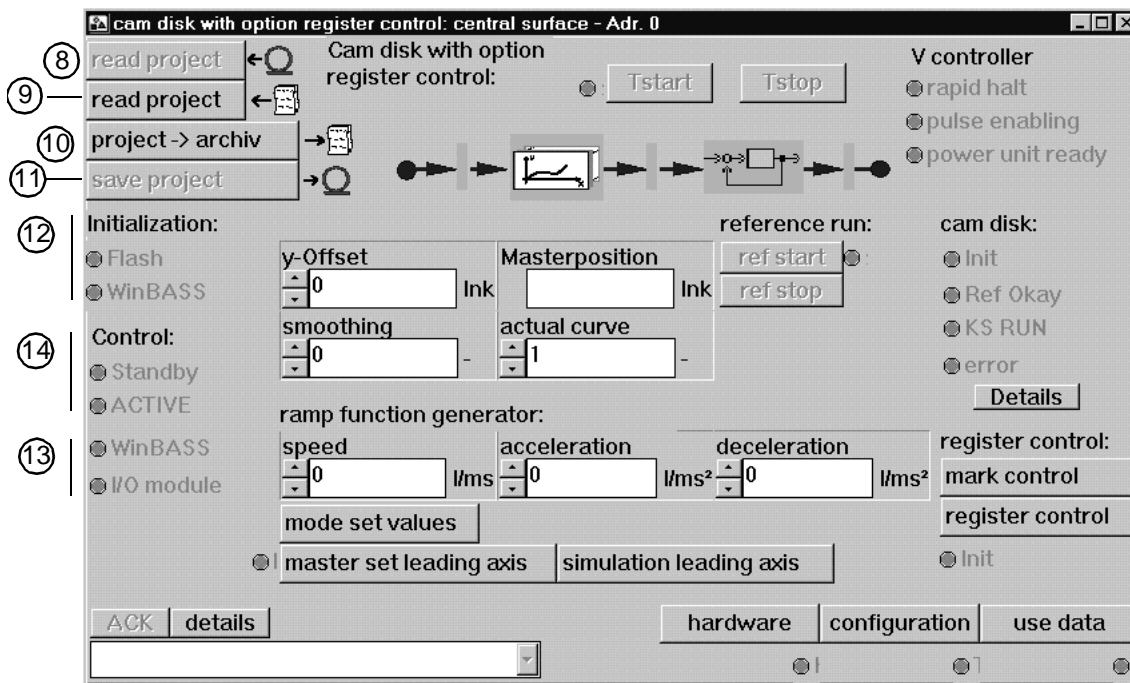

Fig: 44 Central user interface of the technology module cam disk with register control option

- ⑧ The current settings of the technology modules are read and the WinBASS display is updated.
- ⑨ A technology module project saved on the hard disk of the PC is loaded. The **Load project** window opens.
- ⑩ The current settings of the technology module are saved on the hard disk of the PC. The **Save project** window opens.
- ⑪ The current setting which is displayed in WinBASS is saved in the technology module. Initialisation data which is displayed in the windows, can be edited via the **Hardware**, **Configuration** and **User data** buttons. They are saved non-volatile, i.e. your changes are saved after mains disconnection.
- ⑫ When the green **Flash** LED is "illuminated", no controller settings were changed when the technology module was edited via the user interface. When the green **WinBASS** LED is "illuminated", the previous controller setting was changed via WinBASS when the technology module was edited.
- ⑬ When the green **WinBASS** LED is illuminated, the control is via WinBASS. If **I/O module** is "illuminated" the technology module is controlled via the 24-Volt interface or the CANsync bus, depending on the hardware and setting.
- ⑭ The momentary state of the technology module is displayed. **ACTIVE** shows that the drive is enabled and operates according to the technology module settings. In the **Standby** state the drive is not enabled.

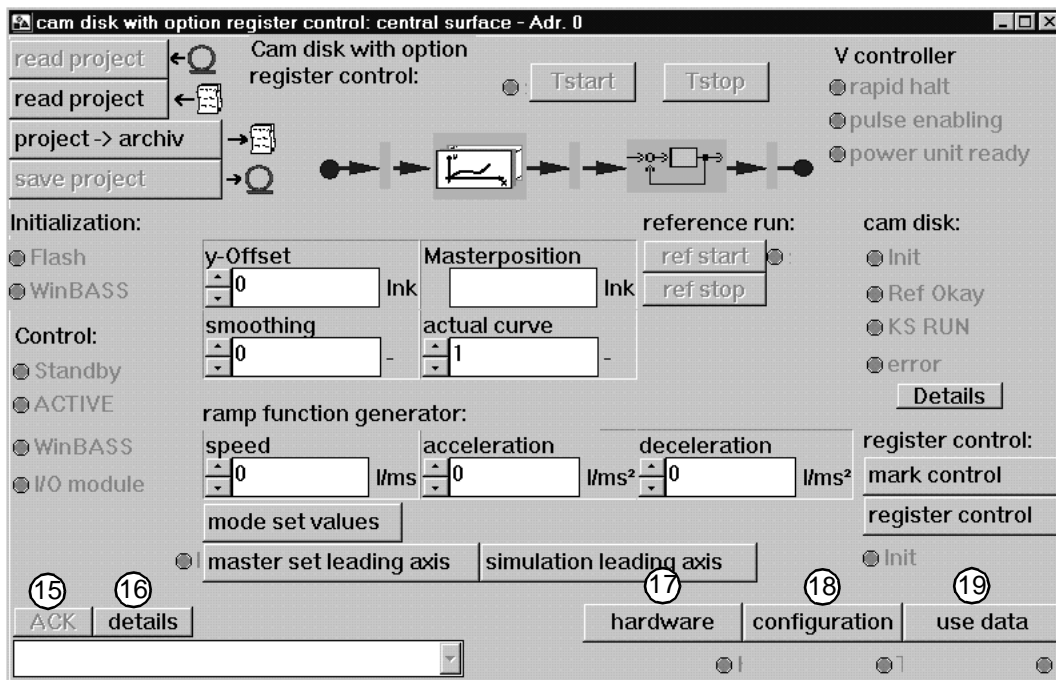

Fig: 45 Central user interface of the technology module cam disk with register control option

- ⑮ The error is reset.
- ⑯ A list of all possible interferences is displayed. The momentary interference is marked or displayed in the window below.
- ⑰ The setting of the hardware used (Ω mega-DriveLine) can be read, checked, accepted, written to the boot data record and edited. The **Hardware configuration** window opens.
- ⑱ The **Configuration** window opens. The technology module *Cam disk with register control option* is configured and saved.
- ⑲ The profile of the cam disk is entered and edited here.

4.2 User data window

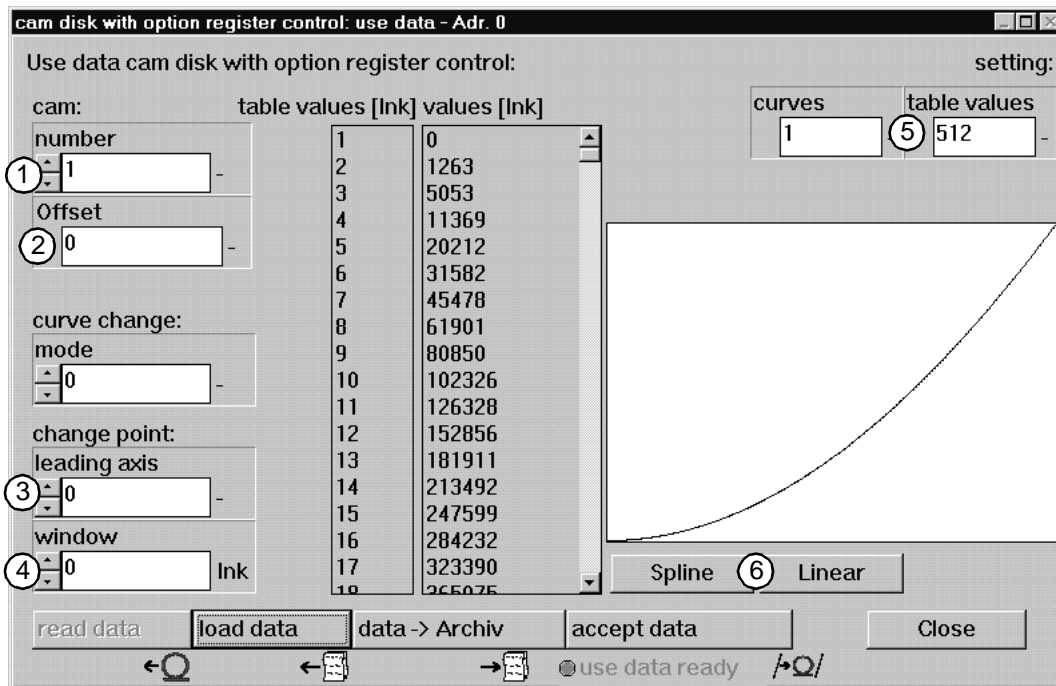

Fig: 46 -

- ① Curve to be edited. You have determined the maximum number of curves in the **Configuration** window.
- ② Offset of the edited curved calculatd by WinBASS. It is calculated and displayed during reading, loading and saving.
- ③ Change-over point of the master axis. [Increments]
0 increments \cong 0°
32768 increments \cong 360°
- ④ Window range for the curve change-over point. [Increments]
0 increments \cong 0°
32768 increments \cong 360°
- ⑤ Display of the maximum number of curves to be configured by you and the interpolation points of every curve. For the input of values see **Configuration** on page 22.
- ⑥ These buttons are used to carry out a spline or linear interpolation between the marked interpolation points. For this, at least two interpolation points must be marked in the table. This is done by pressing the Ctrl-key and clicking with the mouse.
Spline = The connection conditions between the polynoms ensure smooth curves (flexible spline).

4.3 Hardware configuration window

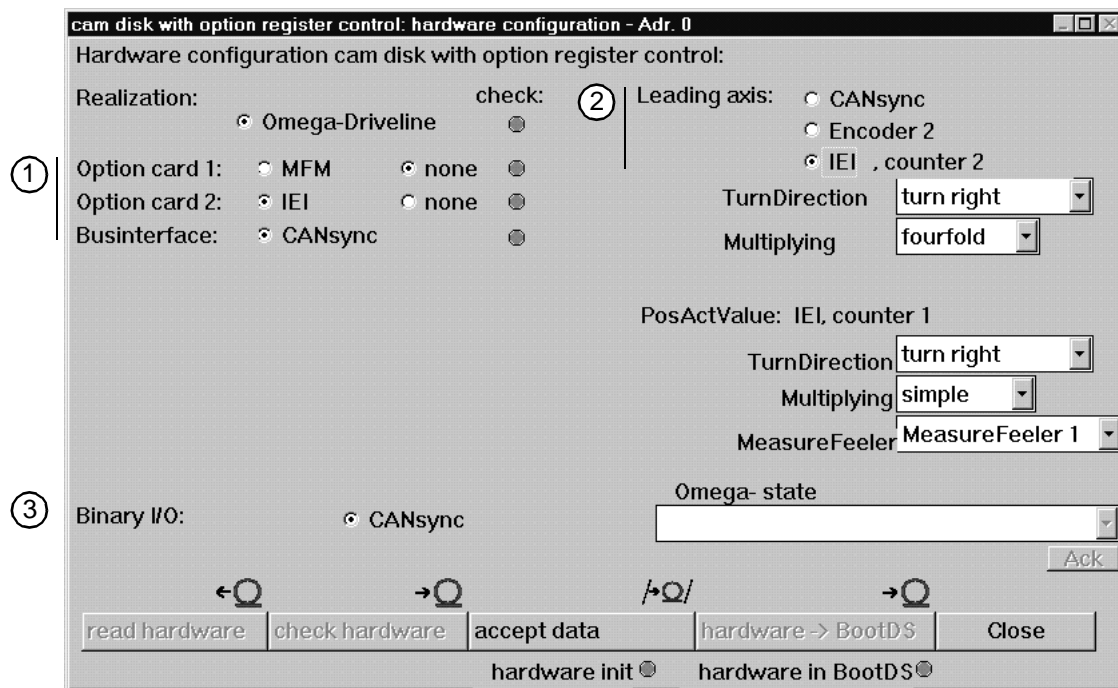

Fig: 47 Window for the hardware configuration

- ① Specify the option boards of your controller.
 MFM = Multi-function module with digital inputs/outputs
 IEI = Incremental encoder interface.
 CANSync = synchronous fieldbus on CAN basis
 After clicking on the **Check hardware** button, all LEDs for the relevant option must be "illuminated". If this is not the case, an error has occurred or the selected option is not available.
- ② Select the source for the master axis. You can select among:
 CANSync = Fieldbus connection
 Encoder2 = X25 connector to V-controller
 IEI, counter 2 = connection via incremental encoder interface counter 2
- ③ When this checkbox is activated, the cam disk is controlled via the CANSync fieldbus. If it is deactivated, it is controlled via the digital I/O on the MFM board.

4.4 Register control – controller window

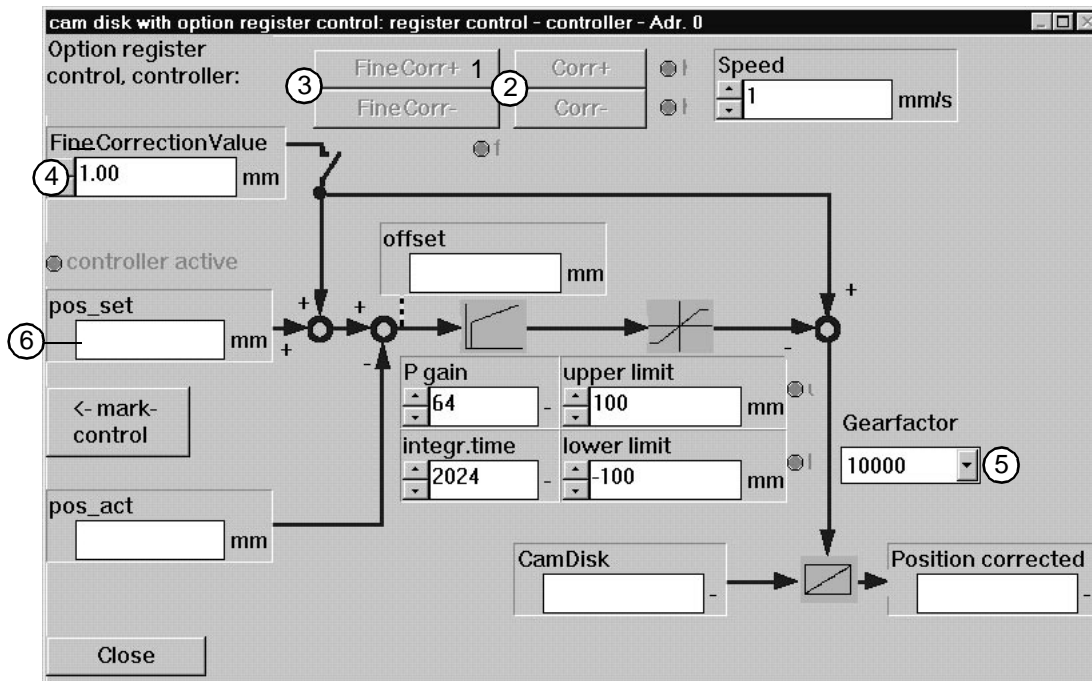

Fig: 48 Process overview of the register control

- ① These two buttons are used to bring the processing position in the register. The processing position is moved until the button was activated. When the buttons are no longer activated, the movement of the processing function stops.
- ② The processing function is changed with this speed during the correction. The unit is mm/s.
- ③ The buttons **FineCorr** are used to correct the setpoint. The setpoint is changed by the fine correction value with every movement.
- ④ When the controller is activated, the setpoint is corrected by this value when you activate the **FineCorr** buttons. The check positions of the print mark check are adjusted automatically. The controller controls the actual value to the modified setpoint. This means that the setpoint can be changed to every value in the format.
- ⑤ This parameter is used to enter the speed and accuracy of the correction. It is used for optimisation. If you enter a small value, the correction is fast. A large value means that the correction is more precise.
- ⑥ Setpoint position in the format. The setpoint position is determined after the drive has been moved to the register and the register control has been activated. The setpoint position is averaged by a variable number of marks. The number of marks for the averaging is set in the template **Configuration>Average values**. You can change the setpoint position by the fine correction buttons and the fine correction value in both directions.

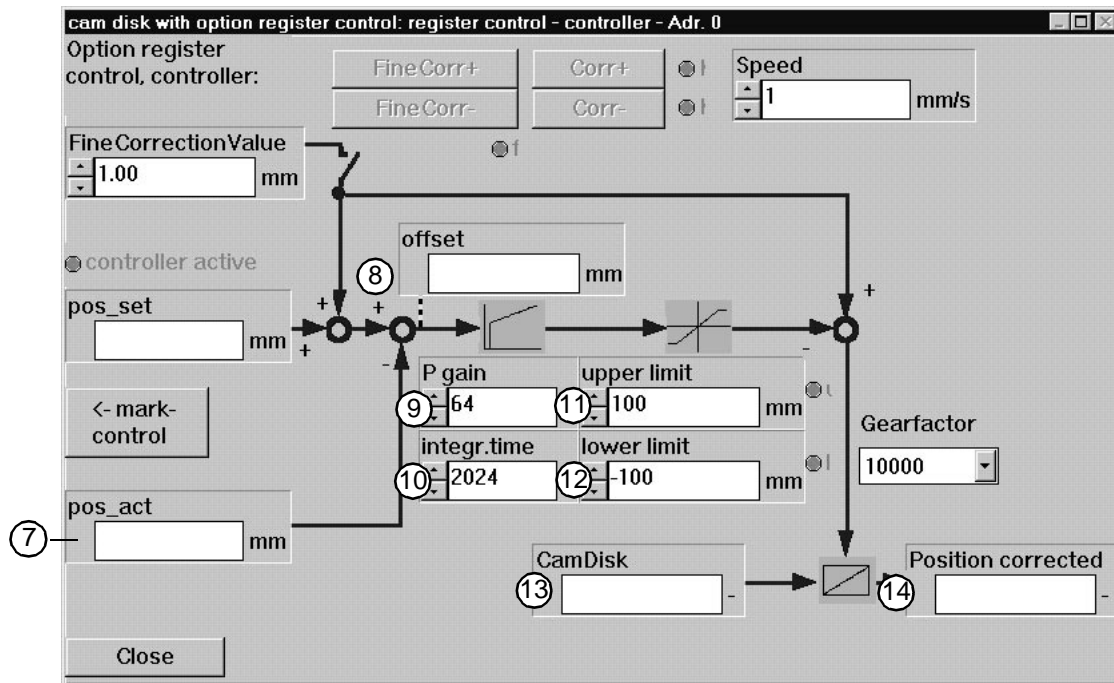

Fig: 49 Process overview of the register control

- ⑦ Currently detected mark position in the format. The actual position is always displayed, independently of the controller activation.
- ⑧ The offset is created from the difference between the setpoint and actual position. You can minimise it in the controller optimisation via the PI controller parameters and the gear factor.
- ⑨ The gain factor for the PI controller is specified here.
- ⑩ The integration time for the PI controller is specified here.
- ⑪ The upper limit for the register offset is set here. This value should not be smaller than the tolerance in the **Mark check** window.
- ⑫ The lower limit for the register offset is set here. This value should not be larger than the tolerance in the **Mark check** window.
- ⑬ Output of the cam disk. The current cam disk position is displayed here.
- ⑭ Output of the register control. The value results from the cam disk position and the ratio of the electronic gear.

4.5 Mark check window

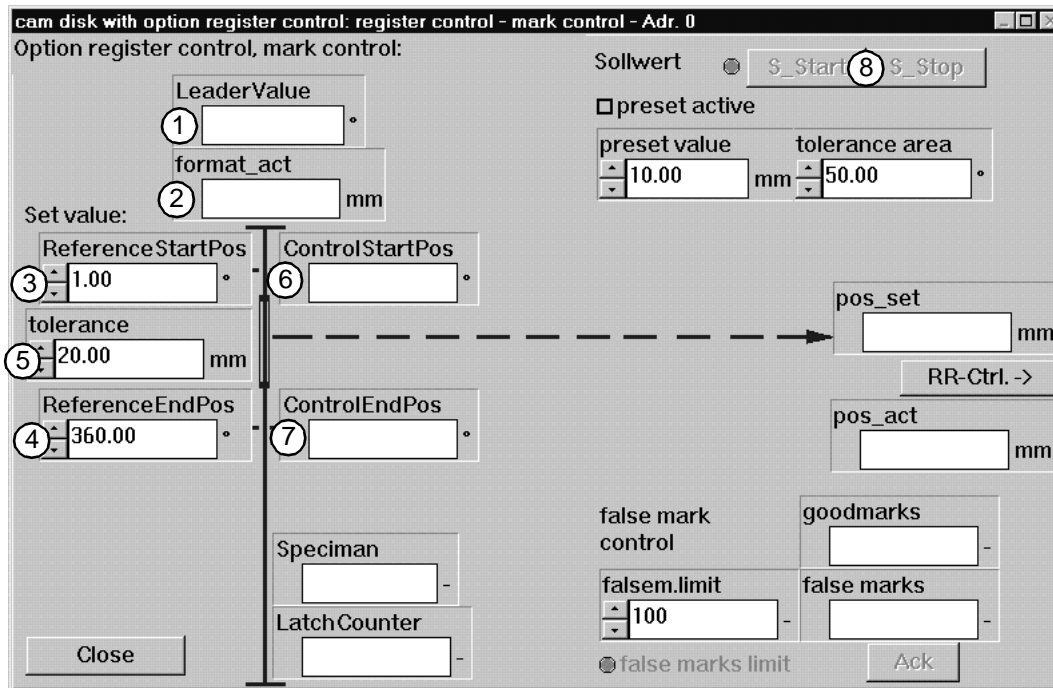

Fig: 50 Input of the tolerance range for the mark check

- ① Current master axis position in degree. One master axis revolution corresponds to one format or one interpolation point sequence of the cam disk.
- ② The configured format length for one master axis revolution. The nominal format is checked during the curve sequence.
- ③ A window is required to detect the setpoint mark to exclude faulty mark detections. The reference start position indicates the start value of the window in the format, in which the setpoint position is to be detected. Mark filter start in the format (360°) for the setpoint detection (Filter = range between reference start position and reference end position)
The value is indicated in degree.
- ④ A window is required to detect the setpoint mark to exclude faulty mark detections. The reference end position indicates the end value of the window in the format, in which the setpoint position is to be detected. Mark filter end in the format (360°) for the setpoint detection.
The value is indicated in degree.
- ⑤ The check value for the maximum offset. Select a large value before clicking on **S_Start**. Adapt the value after the controller optimisation.
- ⑥ The beginning of the mark window for the good mark detection. The window width results from the tolerance range (not tolerance!).
- ⑦ The end of the mark window for the good mark detection. The window width results from the tolerance range (not tolerance!).
- ⑧ Activation of the register control. The electronic gear is switched 1 : 1 in the deactivated state. After the activation using **S_Start**, the setpoint is detected and controlled according to the **Setpoint input active** mode. The active controller is displayed in the **Register control – Controller** window (see **Register controller** on page 35).

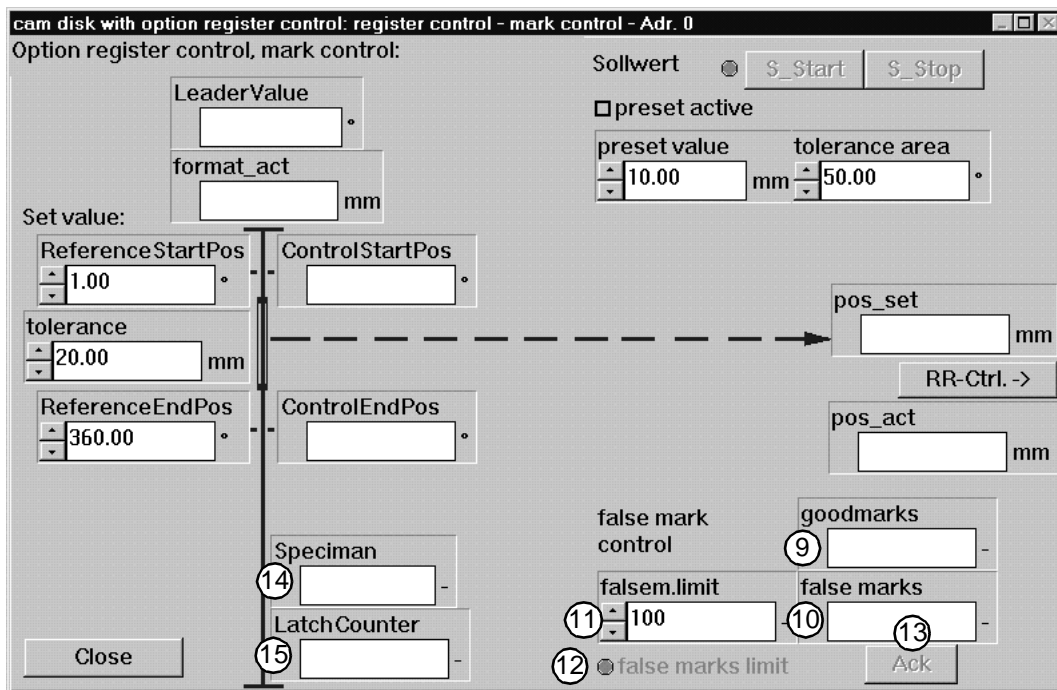

Fig: 51 Input of the tolerance range for the mark check

- ⑨ The number of corrected marks is displayed which have been detected within the mark window and the **Tolerance** .
- ⑩ The number of marks which have been detected out of the mark window. Marks out of the mark window increase the counter. Marks out of the mark window decrease the counter. These marks were not adjusted.
- ⑪ The check limit is the maximum number of missing marks. The register control is stopped when the set check limits are exceeded. This is displayed by the **Limit of missing marks** LED.
- ⑫ When the LED is "illuminated", the check limit for missing marks has been exceeded.
- ⑬ When the limit of missing marks is reached, the maintaining of the register is no longer ensured. The user has to acknowledge the error using the **Ack** button or restart the setpoint detection using **S_Start**. The **Ack** button is used to reset the counter of missing marks.
- ⑭ Number of master axis revolutions. Independent of **S_Start**. Check of the operating mode of the set position detection.
- ⑮ All detected marks are displayed here.
The momentary counter is transferred to the latch counter with every print mark. The user can thus check the correct detection of print marks using the sensor. The value is not dependent on the mark window and displays the total number of detected actual positions.

4.5.1 Setpoint mode selection window

After selecting the relevant menu option, you reach this window (see **Central user interface of the technology module** on page 20).

You can select among eight methods of how to process the cam disk function in the V-controller.

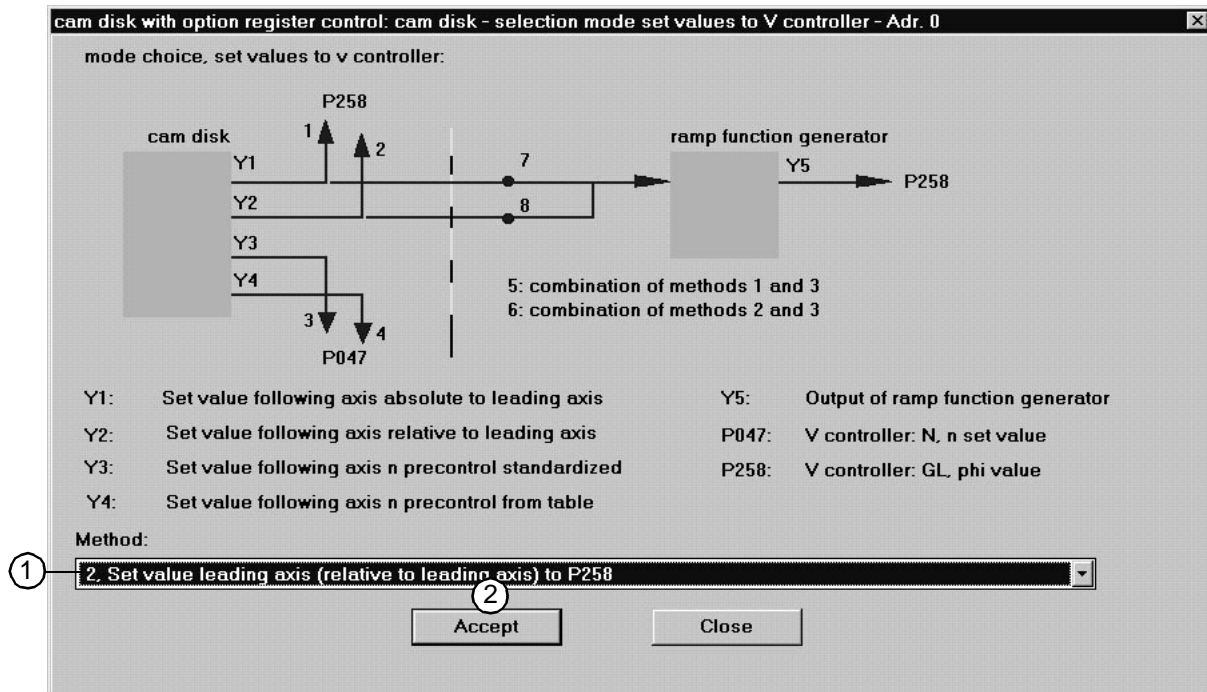

Fig: 52 Selection of the result of the cam disk function for the V-controller

- ① Method 1:
Absolute positioning of the slave axis to the master axis
 - Method 2:**
Relative positioning of the slave axis to the master axis, default setting
 - Method 3:
Slave axis setpoint with internal speed pilot control, scaled
 - Method 4:
Slave axis setpoint with internal speed pilot control, from table
 - Method 5:
Combination of methods 1 and 3
 - Method 6:
Combination of methods 2 and 3
 - Method 7:
Absolute positioning of the slave axis to the master axis using maximum conditions: speed, acceleration, deceleration (on the central user interface)
 - Method 8:
Relative positioning of the slave axis to the master axis using maximum conditions: speed, acceleration, deceleration (on the central user interface)
- ② Save your settings using **Accept**.

4.5.2 Master axis setting angle window

After selecting the relevant menu option, you reach this window (see **Central user interface of the technology module** on page 20). For the commissioning of the real master axis, the slave axis must be referred to the master axis.

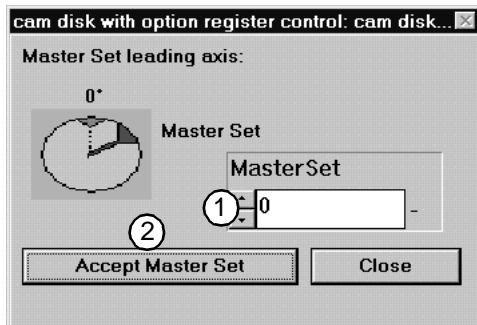

Fig: 53 Master axis setting angle

- ① Enter the setting angle of the master axis depending on the master axis resolution (see **Configuration** on page 22).
Setting angle = $0 \cong 0^\circ$
Setting angle = maximum resolution $\cong 360^\circ$
- ② The setting angle is transferred to the control.

4.5.3 Master axis simulation window

After selecting the relevant menu option, you reach this window (see **Central user interface of the technology module** on page 20). For the commissioning with the **master axis simulation**, its settings must be entered:

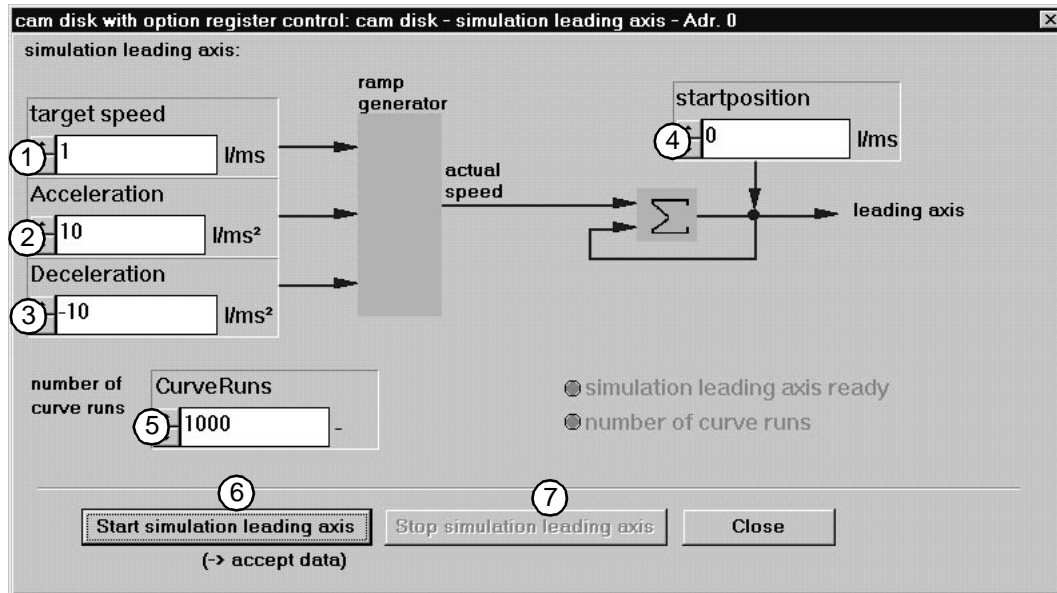

Fig: 54 Configuration and commissioning of the simulation "virtual master axis"

- ① Enter the maximum speed for the "Master axis simulation".
- ② Enter the maximum acceleration for the "Master axis simulation".
- ③ Enter the maximum deceleration for the "Master axis simulation".
- ④ Enter the start position. The value of the start position is added to the value of the master axis position.
- ⑤ Enter the number of curve sequences. When the **number of curve sequences** is reached, the LED is "illuminated".
- ⑥ The simulation is started. Every parameter change ① to ⑤ must be accepted by activating this button.
- ⑦ The simulation is stopped. The number of curves already passed is reset to zero.

5 TROUBLESHOOTING

5.0.1 Detail error list – addr. 0 window

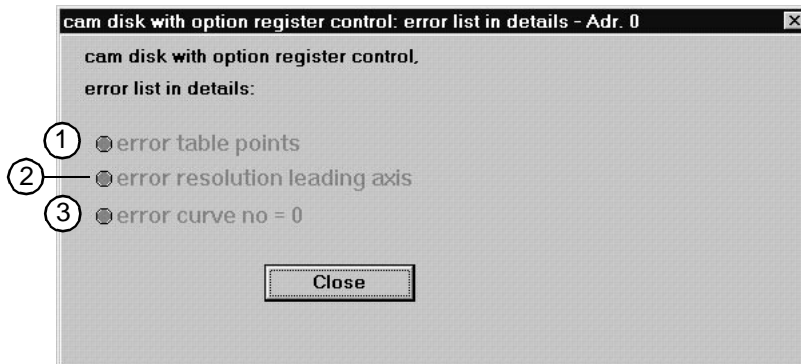

Fig: 55 Detail error list of cam disk

The technology module generates these errors when the requirements for the technology module or the process are not met.

- ① The value for the curve interpolation points in the **Function configuration** window is higher than the maximum permissible number.
Remedy: Check the entered resolution value and correct according to the curve number or change the curve number.
- ② The master axis resolution set in the **Function configuration** window is out of the range from 0 to 65535 or higher values are not raised to the power of two.
Remedy: Check and correct the entered resolution values.
- ③ The selected curve number is not defined.
Remedy: Check and correct the curve number selection at the 24-V interface or CANSync master.

5.0.2 Error detail list Omega – addr. 0 window

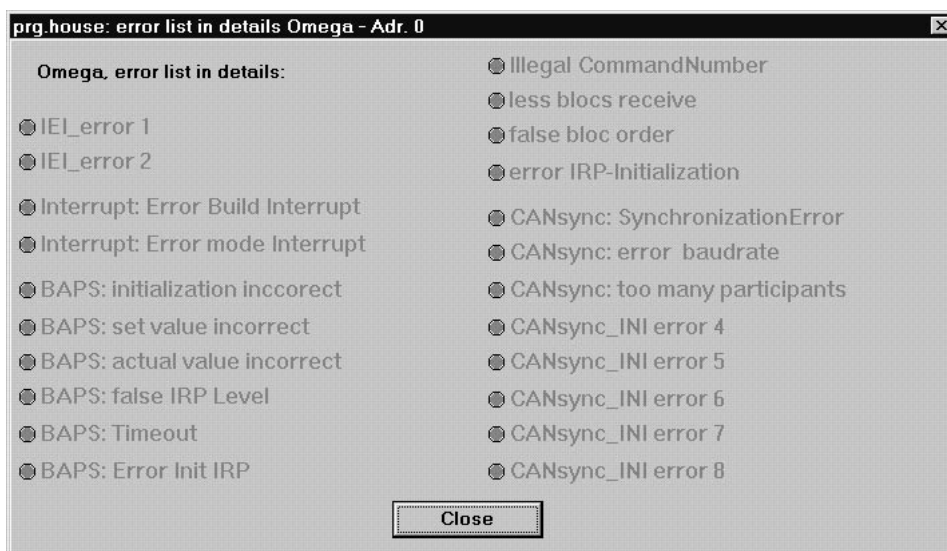

Fig: 56 Error list

Errors inside the system can be removed by restarting the systems (controller + WinBASS) or – if available – by checking the CANSync settings and bus connections.

6 APPENDIX

V

V-controller

14

A

Application examples 8

B

Bus system 39

C

Central user interface 20, 32
Check position 37

D

Drive
 Change 39
 Make connection 39

E

End position 37

F

Features
 important 8
Filter 58
Following error 8
Format 9

I

in-register 9
Interpolation points
 maximal 8

L

Latch 9
 counter 9
Limits 10

M

Marks 9
Mode
 Offline 40
 Online 40

O

Offline mode 40
Online mode 40

P

PC 13
Program shell 19

R

Register control 8
 Accuracy 9

S

Safety notes 5
Setpoint input active 48
Sheet 9

T

Tolerance 37
Tool 35