

**Commissioning
and Maintenance Instructions**

be in motion be in motion

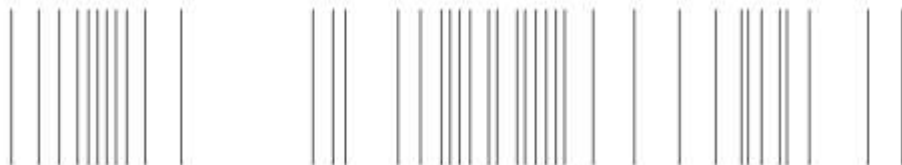

TAM 00699

DSD2 045 - 132

Three-phase-synchronous motor

Version: 04/2018

English



LEGAL NOTES ON DOCUMENTATION

Copyright

This documentation may only be copied, as many times as required, by the owner for internal use. For other purposes, this documentation may not be copied or duplicated either in whole or in part. Utilization by and provision of the contents to third parties is not permitted. Names and company logos used in this documentation may be trademarks, whose use by third parties for their own purposes may infringe the rights of the owner.

Applicability

This documentation is part of the unit/the machine. These Commissioning and Maintenance Instructions must be available to the operator at all times and be in a readable condition.

If the unit/machine is sold or put into storage, the owner must pass on this documentation together with the unit/machine. Following the sale of the unit/machine, this original and all copies are to be passed on to the purchaser. Following disposal or any other form of termination of utilization, this original and all copies are to be destroyed.

With the introduction of this documentation, corresponding documentation with earlier issue dates is superseded.

Please note that all data/figures/information represent **current data at the time of going to press**. These details are **not legally binding** for the purposes of dimensioning, computation, or calculation.

Baumüller Nürnberg GmbH reserves the right to change the technical data and the method of operation of Baumüller products in the context of the further development of the products.

No liability can be accepted concerning the correctness of this documentation unless otherwise specified in the General Conditions of Sale and Delivery.

BAUMÜLLER NÜRNBERG GmbH
Motors Division
90482 Nürnberg, Germany
www.baumueller.com

Table of contents

1	General safety instructions	4
1.1	Safety	4
1.2	Designated purpose	5
1.3	Prohibition of unauthorized modifications and changes	6
2	Operating conditions	6
2.1	Product description	6
2.2	Items supplied	6
2.3	Type plate	7
2.4	Technical Data	8
2.5	Transport, bearing lock, intermediate storage	9
2.6	Installation conditions, cooling details	10
2.7	Balancing, output elements, vibrations	11
3	Mounting	13
3.1	Safety instructions	13
3.2	Installation, mounting	13
4	Electrical connections	14
5	Commissioning, operation	15
5.1	Safety instructions	15
5.2	Checks prior to commissioning	16
5.3	Commissioning, operation	16
5.4	Malfunctions in operation	17
6	Inspection and maintenance	18
6.1	Inspection	19
6.2	Maintenance	19
7	Disposal	19
8	Appendix 1: pole assignment (main connection and Control terminal)	20
8.1	Main connection via plug	20
8.2	Main connection via the terminal box (Standard design acc. to catalogue)	20
8.3	Main connection via the terminal box (customer specific design acc. to EN 60034; non UL-approved)	22
8.4	Main and control connection via combination-mounting-box (customer specific design)	23
8.5	Fan / cooling fan connections via connection socket or terminal box	24
8.6	Control terminal: Resolver	25
8.7	Control terminal: SRS / SRM 50	25
8.8	Control terminal: SEK / SEL 52	26
8.9	Control terminal: ECN 1313 / EQN 1325	26
8.10	Control terminal: ECN 1325 / EQN 1337 (encoder with EnDat 2.2-port of Heidenhain)	27
8.11	Brake connection at the size 132	27
9	 Appendix 2: water-cooled machines	28
9.1	Definitions of power ratings for water-cooled machines	28
9.2	Motor cooling	28
9.3	Instructions for installation	29
9.4	Electrical connections	29
9.5	Specifications for required coolant volume flows	30
9.6	Coolant consistency	31
9.7	Min. coolant temperature against ambient temperature and humidity	31
9.8	Malfunctions in operation	33
9.9	Inspection	33

1 General safety instructions

1.1 Safety

This electric motor has been constructed in accordance with the relevant safety standards and underwent an operational safety check before leaving our factory.

To make sure that the machine is commissioned correctly and used safely, please read the following:

- The Commissioning and Maintenance Instructions and their attached appendices
- The safety and commissioning notes
- The technical documentation that accompanies the product
- The commissioning and safety notes provided by the manufacturer of the converter
- The national, local, and system-specific regulations concerning your finished product
- The technical instruction of TAM 00697 for use in safety-oriented applications

We draw your attention to the following hazards when using the product:

- Hazards resulting from
- Lifting and transport
 - Electrical power
 - Moving parts
 - Hot surfaces
 - EMC interference
 - Mechanical overload
 - Thermal overload

Please, read all the safety instructions and in particular those which are marked with a symbol to avoid injury to people and damage to property and to minimize residual risks,.



Risk of fatality due to electric shock

Failure to observe can lead to fatal or serious injuries.



General dangers warning

Failure to observe can lead to serious injury.



Dangerous situation warning

Failure to observe can lead to damage to the system or peripheral equipment.



Touching prohibited

Failure to observe can lead to serious injury.



Improper handling prohibited

Failure to observe can lead to serious injury.



Hot surface warning.



Magnetic field warning.

Failure to observe can lead to severe injuries or damage to property.



Electrostatically sensitive components

Failure to observe can lead to damage to the system or peripheral equipment.

1.2 Designated purpose

The electric motor must only be used for its designated purpose. In this context, the electric motor must only be used for the applications described in the technical documentation under strict observance of all the notes in these Commissioning and Maintenance Instructions.

All assembly, commissioning, maintenance, and operating tasks must be carried out by qualified personnel only.

Within the context of these safety instructions, qualified personnel refers to persons who are trained and authorized in the specialized area, who are authorized to set up, assemble, commission, and operate units, systems, and circuits under application of the applicable safety standards (EN 50110-1).

Inappropriate behavior can result in serious **injury** and **damage** to property.

The **electric motor** is designed to be used for **industrial applications** and is subject to a number of **standards** and **directives**, including the following:

Standards

EN 60034-1, EN 60034-5, EN 60034-6, EN 60034-7, EN 60034-9, EN 60034-11,
EN 60034-14, EN 60204-1

EU Low Voltage Directive

The electric motors in this series fully comply with the requirements of the Low Voltage Directive EU 2014/35/EU (conformity).

EU Machinery Directive

Electric motors are components which are intended to be installed in machines as described in the Machinery Directive. Commissioning is not permitted until such time as the conformity of the finished product with this directive has been established (refer to EN 60204-1 "Electrical Equipment of Machines").

EU EMC Directive

When the electric motor is used as intended, its operation must comply with the safety requirements laid down in the EMC Directive 2014/30/EU. Proper installation (e. g. physical isolation of signal and power cables, shielded wiring and cable etc.) is the responsibility of the system installer and system vendor. With systems which have converters, the EMC notes from the manufacturers of the converter-, encoder- and brake-manufacturer must be observed.

Furthermore, all the national, local, and system-specific regulations must be observed!

The electric motor is designed for the following **ambient conditions**:

- Ambient temperature: 0 °C to +40 °C
- Altitude: ≤ 1000 m above sea level
- Relative humidity: 5 % to 85 %

Please, take note of any deviating details specified on the type plate or in the technical documentation. The conditions at the place of use must correspond to the details on the rating plate.



Use in areas with potentially explosive atmospheres is **prohibited** unless the unit is expressly designed for this purpose (refer to additional notes). Furthermore, the area surrounding the electric motor must be free of inflammable gas mixtures and hazardous concentrations of dust.

Live and hot motor parts are inflammable and may cause serious injury and damage to property.

If, in special cases (for utilization in non-industrial applications), more stringent requirements are in place, such as protection against contact with a child's fingers, these conditions must be met by the customer when installing the system.

Motor design with rare earth magnets:

	<p>Please be aware of the following risks in the vicinity of a retracted or exposed rotor with a strong magnetic field:</p> <ul style="list-style-type: none">• People with electronic or metallic implants (such as cardiac pacemakers, hearing aids, plates or pins) are at risk, if the distance between the implant and the magnetic pole is less than 0.5 m.• Due to the strong attraction forces exerted on ferromagnetic parts there is a risk of:<ul style="list-style-type: none">○ Bruises○ Damage to measuring and assembly tools, credit cards, watches etc.○ Contamination of the rotor assembly due to attracting metal debris or powder.
---	--

Thermal hazard:

	<p>Beware of risk of burns!</p> <p>The surface temperatures on the motors can exceed 70 °C. If necessary, provide guards!</p> <p>Temperature-sensitive parts, such as normal cables or electronic components, must not be placed on or fixed to the hot surfaces.</p> <p>Thermal overloading can destroy the winding and the bearing and can cause demagnetization of the rare-earth magnets. A thermal sensor should be used to monitor the temperature.</p>
---	---

1.3 Prohibition of unauthorized modifications and changes

	<p>For safety reasons, unauthorized modifications and changes to the electric motor are not permitted. If such modifications/changes are necessary, please contact the motor manufacturer.</p> <p>No safety devices may be dismantled or decommissioned when operating the electric motor.</p>
---	--

2 Operating conditions

2.1 Product description

The "DSD2" series electric motors are 8-pole three-phase synchronous motors with rare-earth magnets. These motors are capable of excellent acceleration performance thanks to the low inertia of the rotor.

When operated in conjunction with a motor-controlled pulse converter, these motors respond extremely well to speed and position control and are highly dynamic. Therefore, they are ideal for applications associated with machine tools and production machines (e. g. printing, packaging, textile machinery), as well as handling devices and robots.

2.2 Items supplied

The delivery is put together on an order-specific basis.

- The carrier must be immediately notified of any damage caused during transit.
- On receipt of delivery, please make sure that the ratings and motor type agree with the order data. In the event of apparent defects or incomplete delivery, the appropriate Baumüller office or the Baumüller head office in Nuremberg should be notified immediately.

In both of the above cases, commissioning may not be made until the error has been removed professionally.

2.3 Type plate

The type plate is used to identify each electric motor. The unique motor number is clearly shown on each type plate and is essential for internal tracking procedures. It must be possible to read the type plate at all times. Never remove the type plate from your motor.

Type plate data:

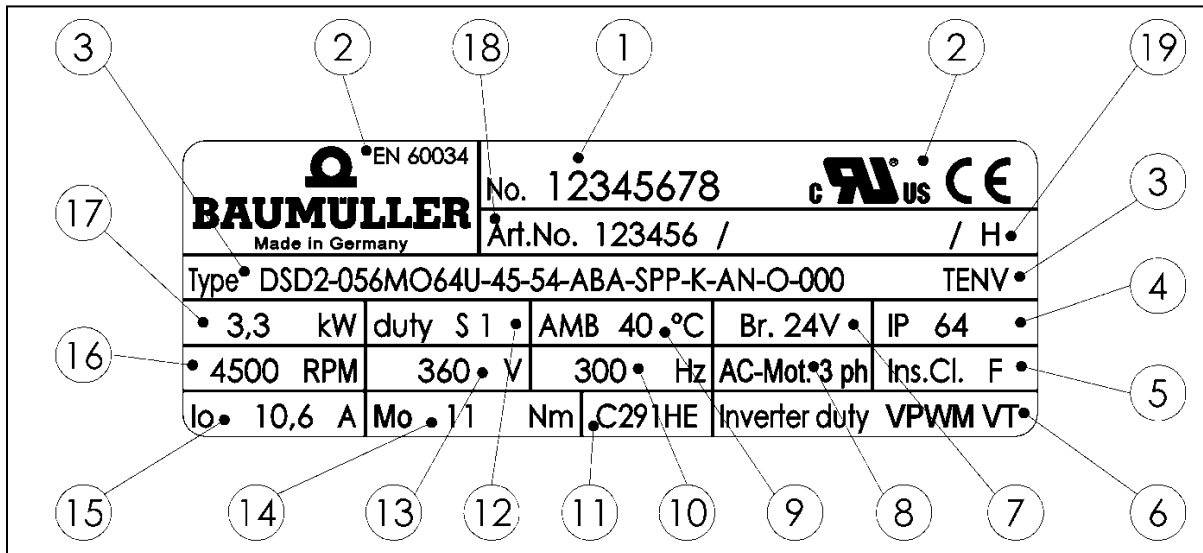

Figure 1: Type plate

- | | |
|--|-------------------------------|
| 1 → Motor number | 10 → Rated frequency |
| 2 → Standards and approbation | 11 → Isolation system UL |
| 3 → Motor type / designation | 12 → Motor operating type |
| 4 → Motor protection class | 13 → Rated voltage U_N |
| 5 → Heat category (class of insulation VDE) | 14 → Standstill torque M_o |
| 6 → Motor is powered with converter | 15 → Standstill current I_o |
| 7 → (optional) Supply voltage of the brakes DC | 16 → Rated speed n_N |
| 8 → Motor type: 3-phase motor | 17 → Rated output P_N |
| 9 → Permitted ambient temperature | 18 → Article number |
| | 19 → Kind of balancing |

2.4 Technical Data

Designs (EN 60034-7)	IM B5	Horizontal installation position
	IM V1	Vertical installation position, shaft end down
	IM V3	Vertical installation position, shaft end up
Note:	For installation according to IM V3 combined with IP 64 ensure protection against the ingress of water and dirt.	
Note:	IM B35	Horizontal mounting position of size 132
The mounting positions IM V1 und IM V3 are not available for size 132.		
Degree of protection (EN 60034-5)	with consideration, of the shaft duct	
	IP 64	Standard: without shaft sealing ring (size 45-100)
	IP 65	Optional: with shaft sealing ring (size 45-100)
	IP 54	size 132
	without consideration of the shaft duct	
	IP 67	for models with self-cooling (IC 410 and IC 3W7); not for motors with terminal box (size 45-100)
	IP 65	for model with surface-cooling (IC 416) (size 45-100)
	IP 65	for model with terminal box (size 45-100)
	IP 54	size 132
Caution:	All specified protection classes are only achieved in the event of completely assembled plug connectors (mains and control connections) and fully closed terminal box.	
Cooling method (EN 60034-6)	IC 410	Standard: completely enclosed motor design, surface-cooled, no fan, size 45-100
	IC 416	Optional: from shaft height 56 completely enclosed motor design, surface-cooled with fan,
	IC 3W7	Optional available as of size 56 completely enclosed motor design, water-cooled,

Electrical connections (see **Appendix 1**) via angled (3x90°) rotatable mounting boxes.

Caution: In the event of idling currents $I_0 > 36$ A the mains connection is via terminal boxes

Main connection	8-pin connector / Terminal box Standard: U V W + thermal sensor Optional: brake	
Control connection	12-pin	Standard: Resolver
	12 / 17-pin	Option: absolute encoder Option: encoder + thermal sensor
	12-pin	Option: Hiperface-port
	17-pin	Option: Endat 2.1 port
	9-pin	Option: Endat 2.2 port
Fan (as an option)	6-pin plug or terminal box	
Thermal motor protection (EN 60034-11)	Temperature sensor PT1000, KTY84 in stator winding	

Winding insulation (EN 60034-1)	Thermal class F($\Delta\theta = 105$ K)
Ambient temperature	0 °C to +40 °C (standard)
Altitude (EN 60034-1)	≤ 1.000 m above sea level (standard)
Rolling-contact bearings with long-term grease lubrication:	Standard: Ball bearing Option (from shaft height 56): Roller bearing (DE-side)
Calculated bearing life	L_{H10} 20.000 h (approximate value)
Vibration severity (EN 60034-14)	standard: level A on request: level B (only for ball bearings)
True running (DIN 42955)	standard: N on request: R (reduced)
Vibration resistant (EN 60068-2-6)	radial: 3 g (10 Hz to 100 Hz) size 45-100 axial: 0,5 g (10 Hz to 100 Hz) size 45-100 radial: 3 g (10 Hz to 55 Hz) size 132 axial: 1 g (10 Hz to 55 Hz) size 132
Holding brake	Option
Actual speed value encoder (request)	Standard: 2-pole resolver (higher quality version on request) Option: absolute encoder with Hiperface-port Option: absolute encoder with EnDat-port

For further technical data, refer to our technical product list online at: www.baumueller.com in the download area under Technical documentation. If necessary, you can request the corresponding documents.

Attention!

If the electric motor supplied is not a standard type as per the technical documentation or if special contractual arrangements have been made, there may be technical differences to these Commissioning and Maintenance Instructions. In this case request the related technical supplements.

2.5 Transport, bearing lock, intermediate storage

Water-cooled motors:

	<p>To avoid frost damages it must be ensured that there is no coolant in the motor during the transport or intermediate storage at ambient temperatures < 3 °C. The blowing out of the cooling water can be made by compressed air.</p>
---	--

Transport:

	<p>The permitted environmental conditions which affect the motor during the transport must be taken from DIN EN 60721-3-2 (class 2K2/2M1). Contrary to the DIN, a reduced temperature range of – 15 °C to + 60 °C is permitted.</p> <p>Suitable lifting tackles must be used, e. g. belt webbing, loop belts etc. If provided, the lifting lugs of the motor can be used for lifting.</p> <p>The motor connectors are not supposed to be used to secure during transport or as lifting lugs.</p> <p>The regulations of the respective countries must be adhered to during transport. Lifting devices and transport and load suspending devices must comply with the relevant regulations.</p>
---	---

For information on weight of the single motors, please refer to the technical documentation that accompanies the product.

The motor shaft and the connection surfaces must be protected against corrosion. The motor may only be transported with a shaft protection cover; damage to the motor shaft must be avoided.

Bearing lock (for motors with cylinder roller bearings only):

	<p>On motors with cylinder roller bearings, the runner must be blocked at the end of the shaft in order to prevent damage during transit.</p> <p>The transport protector must be used every time the machine is moved.</p> <p>If this lock no longer can be used due to mounting of a drive element, other suitable means must be employed for axial fixing of the rotor for transport.</p>
---	--

Intermediate storage:

If a motor is not to be commissioned immediately after delivery, it should be stored inside a building in a dry, dust-free and low-vibration room ($V_{\text{eff}} \leq 0.2\text{mm/s}$).

The electric motors should not be stored longer than 2 years at a consistent temperature which is within the temperature range of -15 to $+60$ °C. Elevated storage temperatures within the framework of the working temperature accelerate the rate at which seals and bearing grease deteriorate and therefore have a negative impact on the service life even before the unit has been commissioned. Direct exposure to incident solar radiation, UV light and ozone also lead to an ageing of the gaskets and must be avoided!

Please note that the warranty periods commence from the date of delivery. For this reason, we recommend that storage periods are kept to a minimum.

Should nevertheless a longer storage be necessary, the environmental conditions acc. to DIN EN 60721-3-1 (class 1K2/1M1) have to be observed. Contrary to the DIN, an expanded temperature range of -15 °C to $+60$ °C is permitted.

2.6 Installation conditions, cooling details

	<p>For motors with water-cooling please take Section 9 into account in addition.</p>
---	---

Surroundings:

The motor can be installed in roofed rooms complying with the degree of protection in dusty or damp environment and under normal climatic conditions.

Unless alternative arrangements have been made, the motor is designed by default for the following climatic conditions:

- Ambient temperature 0 °C to 40 °C
- Installation height ≤ 1000 m above sea level
- The relative humidity reaches 5 % to 85 %

All other allowed application conditions have to correspond to DIN EN 60721-3-3 (class 3K3/3Z12).

It is absolutely imperative to comply with these climatic conditions when installing the unit.

Aggressive, corrosive, abrasive and plastic-dissolving solutions should be kept well away from the motor and the air that is used to cool it.

Consultation with the motor manufacturer is essential in the case of installation outdoors.

Air cooling:

For ambient conditions, see **Section 2.4** and the technical documentation that accompanies the product.

Cooling method IC 410 – Self-cooling **without** a fan.

Cooling method IC 416 – Surface cooling **with** a fan.

The following must be observed:

- The installation conditions must not impair thermal convection and radiation.
- The cooling air used for forced ventilation must be able to flow in freely and the hot air must be able to flow out freely. The hot exhaust air must not be sucked back in.
- A clearance of at least 100 mm must be observed in relation to neighboring machine parts.
- If installed in very dirty locations, the housing surface and airways must be cleaned regularly.
- The motors with the size 132 require a minimum air volume during air cooling of $\geq 5,8 \text{ m}^3/\text{min}$ (**required minimum pressure height of $\geq 370 \text{ Pa}$**)

flange connection:

By connecting the motor to the mounting surface, a part of the motor loss performance is lead away via the flange. The dimensions of the mounting surface based on their axis height are listed in table 1. This information provides minimum values for the safe heat dissipation via the motor flange surfaces.

Axis height	Steel plate, width x height x thickness in mm	Mounting surface in m ²
45	250 x 250 x 10	0.06
56 – 100	450 x 400 x 30	0.18

Table 1: Mounting surfaces

The heat dissipation conditions approve on larger mounting surfaces. An insulated mounting of the motors is not permitted.

2.7 Balancing, output elements, vibrations

	<p>Do not subject the shaft or bearings to impacts.</p> <p>On mounting and dismounting output elements, it is not permitted for any axial forces to be applied to the motor.</p> <p>The generally applicable measures for the protection of output elements against physical contact are to be followed.</p> <p>If a motor is to be commissioned without output elements, measures must be taken to ensure the key is not flung out.</p>
---	--

Balancing

In the optional design, the rotors are dynamically balanced with a half key (in accordance with DIN EN 60034-14 / DIN ISO 21940-32 / ISO 1940)).

NOTE: Observe the type of balancing as identified on the shaft end face and on the type plate:
H = Balancing with half key (standard design)
F = Balancing with full key (special design)
N = Balancing without key (special design)

Output elements:

On mounting the output element, pay attention to the related type of balancing. The output elements must themselves be balanced in accordance with ISO 1940.

Suitable jigs are always to be used for fitting or removing output elements (e.g. clutch disk, gear, pulley).

- Use the threaded hole in the end of the shaft.
- When pulling, use intermediate washers to provide the shaft with mechanical protection.
- When hoisting heat up the drive elements if required (max. permissible temperature at shaft end 150°C).

Attention:

- On shaft versions without a key, the output elements are to be fastened to the output shaft **by means of suitable clamping sets**.
- On shaft versions with a key, it must be ensured that **the output elements rest on the shaft shoulder**. *Note:* The chamfer or radius on the output element and the shaft radius on the shoulder must be matched.
- Is the tapped hole in the end of the shaft used for axial securing of output elements (e. g. belt pulley), the maximum tightening torque acc. to following table 2 must not be exceeded.



	Thread	Tightening torque in Nm
	M5	2,2
	M8	10,0
	M10	19,0
	M12	33,0
	M16	80,0
	M20	160,0

Table 2: Tightening torque for safety screw S of a belt pulley

appropriate measures for securing screw must be applied

Vibration:

	<p>The site vibration response of the system, which is determined by the output elements, the mounting conditions, the alignment, the installation, and the effects of external vibrations, may cause the vibration values at the motor to increase.</p> <p>In the interest of reliable motor operation and a long bearing service life, the permitted vibration values in accordance with EN 60034-14 should not be exceeded. Under certain circumstances, the rotor may need to be fully balanced with the output element (in accordance with ISO 140).</p> <p>The vibration value after mounting must not exceed the permitted rates of acceleration (comp. Section 2.4)</p> <p>Where there are deviations from normal operation – e. g., rise in temperature, noises, vibration – switch off the motor. Identify the cause and, if necessary, contact the manufacturer.</p>
---	--

3 Mounting

3.1 Safety instructions

Before mounting:

	<p>Never mount or commission a damaged electric motor. Never install the electric motor in a damaged machine. Before mounting the electric motor, make sure it is suitable for your machine.</p>
---	--

During mounting:

	<p>Only mount the motor using the fastening features provided. The motor should not be exposed to knocks, e. g., with a hammer, or shocks when mounting. Make sure that all covers and safety devices are mounted. All safety devices must comply with the latest regulations (e. g. EN 60204). Air cooling: Protective guards have to be fitted to the air inlets and outlets, if there is a risk of foreign bodies falling into the fan during operation.</p>
---	--

3.2 Installation, mounting

Prior to and during mounting, check that

- the motor is not damaged (e. g. the shaft sealing ring must not have sustained any damage at all from sharp or pointed objects).
- the motor is not mounted in the danger zone of other equipment.
- the motor is used for the designated purpose (comp. **Section 1.2, Section 2.4**).
Observe type plate details, warning labels, and signs.
- anti-corrosion agents have been fully removed from the shaft ends.
- *If a common solvent such as acetone or a cleaning solvent is used, it must not be allowed to wet the shaft sealing ring.*
- the motor is designed for the ambient conditions and environmental influences on site (comp. **Section 2.4**).
- the mounting space in the machine is suitable for the cooling method employed for the electric motor. *The motor has to be mounted in such a way as to guarantee sufficient waste heat removal via the housing and motor flange surfaces; during air cooling the incoming air and the outgoing air must be able to flow freely so that the outgoing air is not drawn in again; at water cooling the connection of cooling supplies is possible (compare chapter. 2.6 and 9).*
- That there is enough space in the machine to connect the motor and for inspection and maintenance works. In order to obtain the installation dimensions of the motor including the tolerance specifications refer to the technical documents or your dimension drawing
- the motor can be mounted and operated with the connection data and fastening features provided.
- *The mounting dimensions of the motor and the tolerance details are provided in the technical documentation.*
- *When flanging to the motor, make sure that the flange surface is in good, even contact. The supports and bearing surfaces must be clean and undamaged. They must be precisely aligned with the connecting shafts to prevent exposure of the bearings, shafts and housing to damaging loads through misalignment. When tightening the flange mounting screws (**min. strength class 8.8**), make sure that the flange connection is not distorted.*
- no liquid can penetrate the upper bearing when installing vertically with the shaft end facing upwards.

- the permitted radial forces according to the operating characteristics in the technical documentation that accompanies the product are not exceeded (if necessary, contact Baumüller for clarification). *The motor manufacturer must always be contacted if axial forces occur.*
- the brake (optional) can be released once the operating voltage has been applied (audible operating noise).
- the rotor rotates smoothly without a scraping sound.
On motors with a brake fitted, release the brake beforehand.
- the design of the motor and encoder cables – and of the fan cable (if available), complies with the details in the technical documentation that accompanies the product.
- the output and input elements are secured.
- the complete cooling circuit is leak proof and fully functional and protected against any foreign objects falling into it.



4 **Electrical connections**

Important notes:

	<p>All work must be carried out by specially trained personnel.</p> <p>Work must only be carried out when the system is electrically isolated and secured against unintentional restarting (also auxiliary circuits).</p> <p>Work must only be carried out once the motor has come to a standstill. <i>In the case of three-phase synchronous motors with permanent magnet excitation, voltages of > 60 V can occur at the motor contacts with the rotor running.</i></p> <p>Regulations for working in electrical plants must be observed!</p>
---	--

Attention! The safety regulations for work on electrotechnical systems in accordance with EN 50110-1 must be followed:

- Isolate
- Secure against unintentional restarting
- Verify safe isolation from the supply
- Earthing and short-circuiting
- Safeguard or cover adjacent live parts

 	<p>The electric motor must be operated by a correspondingly designed converter. A direct connection to the three-phase mains can destroy the motor.</p> <p>Ensure that the phase sequence and the pin assignment are correct!</p> <p>Electrical connections, protective conductor connections, and screen connections (when using screened cables) must be permanently secure!</p> <p>Never touch the contacts of the encoder or thermal sensor with your hands or with tools which are or may be electrostatically charged. The encoder and the thermal sensors are electrostatically sensitive components.</p>
--	--

Electrical installation:

- The person setting up the system is responsible for correct electrical installation.
- The motor data on the type plate must be observed.
- Connection cables and connectors must be correctly rated for the voltages and currents and must be suitable for the method of installation employed.
- The motor and the modules (brake, encoder, fan etc.) must be connected in accordance with the details on the wiring diagrams (see **enclosed wiring diagrams** and **Section 8**).
- Screened power and encoder cables must be used to protect against electromagnetic EMC interference from motor cables and their effects on the encoder and control systems. Please refer to the EMC notes provided by the supplier of the converter.

- In the interest of ensuring operational safety, we recommend that you use connecting cables assembled by Baumüller (see Technical Product List).
- Before connection, the plugs, sockets and the terminal boxes must be checked for damage, corrosion, dirt and dampness.
- Ensure the connections are made correctly and are tight. Seals and sealing faces on the connectors and the terminal boxes maintain the type of protection.
Note! Also in the interests of safeguarding the degree of protection, the rotatable junction boxes should not be turned in their direction of connection more than 5 times altogether.
- Connectors and terminal box connections must not be exposed to mechanical stress. If necessary, protect against strain, shearing, twisting and kinking.

In case of connection using a terminal box it is to be ensured

- the insulation is not over stripped, i. e. that the insulation extends right up to the cable lugs or terminals. The ends of the cables must not protrude.
- the cable lugs that are used are suitable for the dimensions and cross-sections of the terminals and cables.
- the screwed electrical connections are tightened in accordance with the specified tightening torque (comp. **Section 8.2 table 4 / 8.3 table 5**).
- the protection type is maintained.
Note: All lead-ins that are not used must be closed off with the sealing caps. The sealing elements must be fully functional and undamaged when closing the terminal box.



5 Commissioning, operation

5.1 Safety instructions

Working on the electric motor:

	<p>Work must not be carried out on the electric motor until the motor has come to a standstill and is electrically isolated. All connections, such as screw connections, that were loosened when working on the motor must be tightened again prior to commissioning.</p> <p>When carrying out work on the motor, please observe the technical instructions and notes in the respective sections in these Commissioning and Maintenance Instructions.</p> <p>Attention: If the optional holding brake is fitted, it must not be used to secure anything while working on the motor (e. g. for retaining loads)!</p>
---	--



Risk of fatality due to electric shock:

	<p>Make sure that the motor is disconnected and electrically isolated.</p> <p>Never disconnect the motor connections during operation.</p> <p>Only connect measuring instruments when the motor is disconnected from the power supply and electrically isolated.</p> <p>Only commence work on the motor connections when you are sure the motor is electrically isolated and there is no potential.</p>
	<p>When in operation, electric potential can be found at the motor terminals / contacts and at the motor windings. Never touch these modules / elements while the motor is in operation.</p>

Installing and uninstalling safety devices:

	<p>The electric motor may not be commissioned without first mounting the safety devices.</p> <p>The motor must be put out of operation when installing and dismantling components and systems which are provided for monitoring the motor for safe operation.</p>
---	---

Danger on physical contact:

	<p>Make sure that the electric motor has come to a standstill and is secured against accidental restarting before you touch it.</p> <p>Only touch the output shaft when it is electrically isolated and the motor has come to a standstill. Otherwise there is a risk due to the rotating rotor.</p>
	<p>Danger of burns! Never touch the motor housing when the motor is running at rated load. The surface temperatures on the motors may exceed 70 °C.</p>

5.2 Checks prior to commissioning

- The drive is undamaged and is not located within the danger zone of other equipment.
- The motor is correctly aligned and fastened. All screwed connections are correctly tightened.
- All the appropriate safety devices (mechanical, thermal, and electrical) are mounted.
- The motor connections have been made correctly.
- The protective conductor system is correct and its functionality has been checked.
- The cables are not in contact with the surface of the motor.
- The drive is not blocked (release brake, if present).
- Emergency stop functions have been checked
- Fan is connected properly and its function has been checked.

5.3 Commissioning, operation

Notes on the brake function (if present):

	<p>The brake is designed as a holding brake with an emergency stop function. (power failure and emergency stop)</p> <p>It must not be used as a working brake.</p>
---	--

Commissioning must be carried out exclusively by qualified personnel.

Please refer to the commissioning instructions for the converter and the cooling system.

Checks during commissioning:

- Release the brake, if necessary.
- Have all the modules of the motor such as the brake, encoder, fan etc. been checked and are they in compliance with the conditions of use?
- Were all electrical connections executed correctly and tightened properly? (**observe wiring diagrams, see Section 8 and respectively the enclosed wiring diagrams**).
- Have all protection measures which eliminate the possibility of physical contact with live parts, hot surfaces, rotating and moving parts been followed and are these measures fully functional?
- Have all output elements been mounted and adjusted in accordance with the manufacturer's instructions?



- Are measures in place to ensure that the maximum permitted speed n_{max} of the motor cannot be exceeded? The maximum permitted speed n_{max} is the highest permitted operating speed for short-time duty.

Checks during operation:

- Listen out for unusual noises.
- If scraping, scratching, grinding, or other similar noises occur, stop the drive immediately and locate the cause.
- Check the motor surface and connection cables for dirt (such as layers of dust, oil deposits, dampness and leakiness etc).
- Check the maintenance intervals.
- Check air inlet and outlet ports for dirt.

5.4 Malfunctions in operation

Safety instructions:

	Troubleshooting and rectification must only be performed by qualified personnel. Do not disconnect any of the safety devices – even during test runs.
	Only disconnect and connect electrical cables when electrically isolated and secured. Observe the 5 safety rules for "Isolation" (see Section 4).
	Beware of hot surfaces!

In case of malfunctions in operation always

- Refer to the operating instructions for the machine/system.
- Refer to the operating instructions for the converter.
- If necessary, contact the manufacturer of the motor or converter.

Have the following information ready:

- Type plate data
- Type and scope of the malfunction situation on occurrence of the malfunction
- Application data (torque cycle, speed and forces over time; ambient conditions)

The following selection of possible causes can be helpful in the troubleshooting process:

Malfunction	Cause	Remedy
Motor does not start	No controller enable	Activate controller enable
	Controller fault, encoder fault	Read out fault list on the converter or controller; rectify faults
	Brake does not release	Check control, connections, and power supply
	Faulty brake	Repairs carried out by manufacturer
	No power supply	Check connections and power supply
	Rotating field	Check phase sequence. If necessary, switch over the connecting cables

Malfunction	Cause	Remedy
Uneven running	Insufficient screening on connecting cables Controller parameters too high	Check screening connection and grounding Optimise controller parameters
Vibrations	Coupling element or driven machine poorly balanced Inadequate alignment of the drive train Fixing screws loose	Rebalance Realign machine set Check and tighten screwed connections
Running noises	Foreign bodies in the motor Bearing damage	Repairs carried out by motor manufacturer Repairs carried out by motor manufacturer
Temperature rise in the motor Motor temperature monitoring unit trips	Drive overload Motor surface/airways dirty Filter is very dirty(at the motor size 132) Has been installed in an area that does not allow enough space Brake not releasing fully – brake dragging	Check motor load and compare with type plate Clean motor surface/airways Check and clean or replace if required Check motor has been installed in acc. with Sections 2.6 and 3 Have repaired by the motor manufacturer
Current consumption too high, motor torque too low	Indexing angle incorrect	Check indexing angle and adjust if necessary

Table 3: Malfunctions

6 Inspection and maintenance

Working on the electric motor:

	<p>Work must not be carried out on the electric motor until the motor has come to a standstill, is electrically isolated, de-pressurized and has cooled down. All connections, such as screws on the motor that were loosened must be tightened again after the inspection and maintenance work.</p> <p>When carrying out work on the motor, please observe the technical instructions and notes in the respective sections in these Commissioning and Maintenance Instructions.</p> <p>When carrying out maintenance work, observe all safety instructions which also apply to the commissioning of the motor (see Section 5.1).</p> <p>Attention!: If the optional holding brake is fitted, this brake must not perform a safety function during work on the motor (e. g., retaining loads)!</p>
---	--

6.1 Inspection

Depending on the severity of soiling on site, cleaning will have to be carried out regularly to guarantee the continuous adequate dissipation of heat. The flow rate and the pressure ratio of the cooling system must be checked.

If an optional brake is fitted, wear limits are specified (e. g., maximum permissible operating air gap, maximum number of emergency braking operations). The actual degree of wear on the brake must be checked at regular intervals. When the permissible wear limits have been reached, the brake must be replaced (see **Section 6.2**).

If an optional shaft sealing ring is used, it must be checked at regular intervals to ensure it is functioning correctly (leakage).

6.2 Maintenance

The service life of the bearings and sealing elements can differ greatly depending on the operating conditions, (e. g. operating mode, temperature, speed and load).

In the case of trouble-free operation, we generally recommend the following maintenance procedures:

- Replacement of the **bearings** after 20.000 running hours (the bearings are designed for a calculated service life of 20.000 running hours)
- Replacement of the **shaft-sealing ring**, if applicable, if a leakage occurs.

If an optional **brake** is fitted, it is essential that it is replaced when its wear limits are reached.

The maintenance work is to be undertaken by Baumüller or a specialist organization authorized by Baumüller.

The independent maintenance works of an operator are the following:

- The cleaning of the motor surfaces and of the air channels.
- The replacement or cleaning of the filter mats when using dust filters (as at motor size 132):
Dust filters should generally be cleaned or replaced after 100 operating hours. If there is high pollution the service intervals are to be reduced.
Filters polluted by dry dirt can be cleaned by vacuuming, blowing them out or beating them. Filters polluted by wet dirt can be rinsed out in lukewarm water while adding a commercially available washing agent and then drying them.
Note: If the filter mats must be replaced then use original replacement filters of the motor manufacturer, only. These can be requested from Baumüller under specification of the motor number as well as of the order number (see type plate).

Caution!

The specifications of the technical instructions TAM 00697 must be followed during maintenance and servicing on motors which are used for safety-oriented applications.

7 Disposal

The motor must be disposed of in accordance with the relevant national and local regulations within the framework of the normal recycling process.

Note: The motor rotors include rare earth magnets with a high magnetic energies. Refer to the note in **Chapter 1.2**

The encoder electronics (if an absolute value encoder was integrated optionally) must be disposed of in the proper manner as electronic scrap.

8 Appendix 1: pole assignment (main connection and Control terminal)

Key:

- U; V; W Power connection
- K+ / K- Temperature sensor (KTY84-130)
- R1 / R2 Temperature sensor (PT 1000)
- BD+ / BD- Brake
- SL Earth conductor

8.1 Main connection via plug

The standstill current I_0 of the motor determines the size of the built-in box.

Size 1: I_0 to 20 A

Size 1.5 I_0 to 36 A

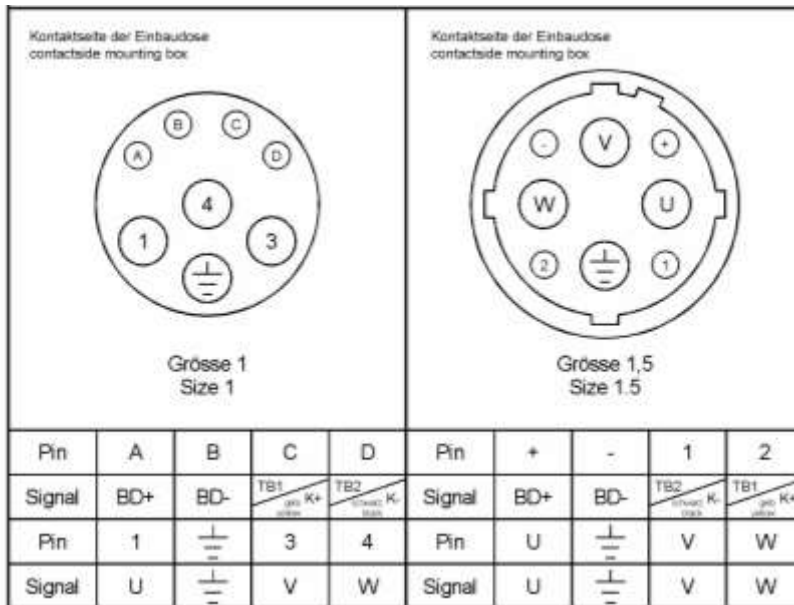

Figure 2: Main connection with thermal sensor and brake

Note: If the **temperature sensor** is wired ideally via the encoder cable, then the signals **K+** and **K-** are omitted in the above diagrams.

8.2 Main connection via the terminal box (Standard design acc. to catalogue)

Use during standstill current $I_0 > 36$ A.

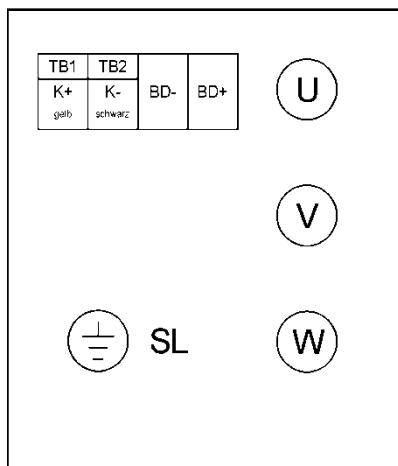

Figure 3A: pole assignment with thermal sensor and brake at motor sizes of 56 to 100

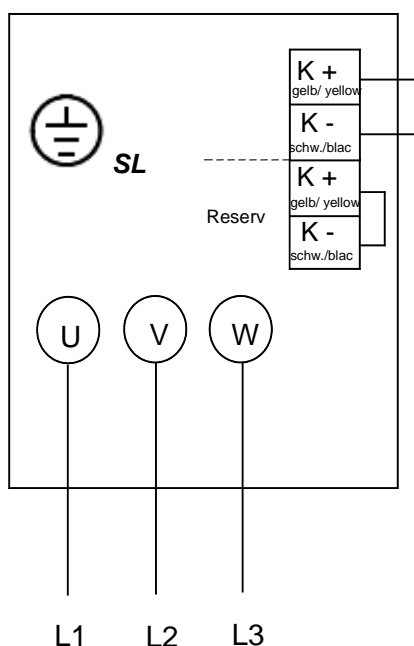

Figure 3B: Pole assignment with thermal sensor and brake at a motor size of 132

Attention:

At the temperature sensor KTY 84 the polarity must be considered while connecting. **Please, comply with the safety notes in Chapter 4**

Table 4 shows the cable leads of the terminal boxes and the main connector pin assignment together with the permissible torque specification.

On the connections for the cable leads we recommend the use of EMC connectors.

When tightening the terminal screws, it is recommended to hold against the conductor, to keep the terminal board free from torsion forces.

Terminal box size	Cable entries	Number of main connection terminals	Terminal torques in Nm
□ 156	1 x M40 + 1 x M25	3 x M6	3,0
□ 196	1 x M50 + 1 x M25	3 x M8	6,0
□ 258	2 x M25 + 1 x M25	3 x M8	6,0
	2 x M40 + 1 x M25		
	2 x M63 + 1 x M25		
	2 x M63 + 1 x M25	3 x M10	10,0

Table 4: Terminal box versions

8.3 Main connection via the terminal box (customer specific design acc. to EN 60034; non UL-approved)

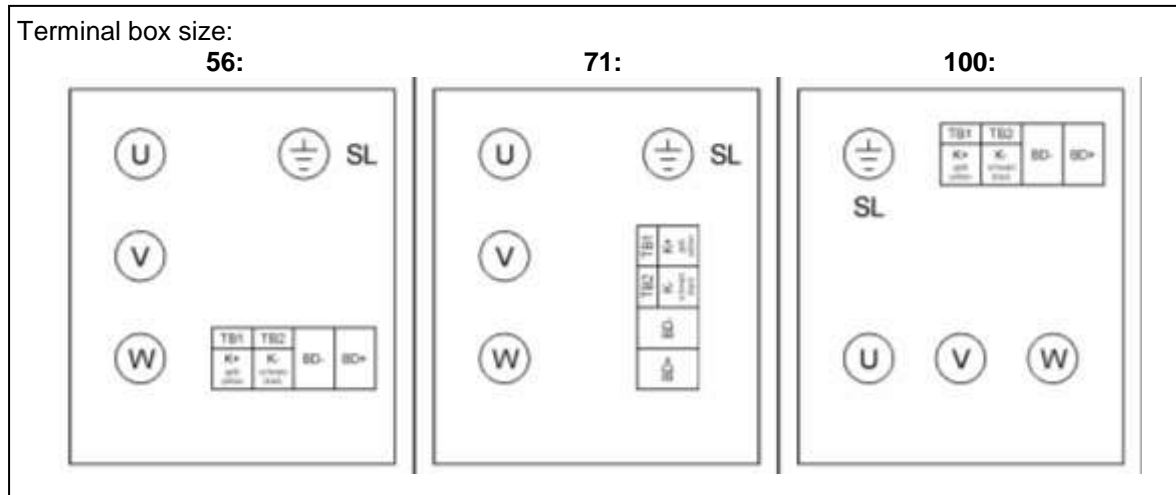

Figure 4: pole assignment special variant

Table 5 shows the cable leads of the terminal boxes and the main connector pin assignment together with the permissible torque specification.

On the connections for the cable leads we recommend the use of EMC connectors.

When tightening the terminal screws, it is recommended to hold against the conductor, to keep the terminal board free from torsion forces.

Terminal box size	Cable leads	Number of main connection terminals	Torques for terminals in Nm
56	1 x M20 + 1 x M16	3 x M4	1,2
	1 x M25 + 1 x M16	3 x M4	1,2
71	1 x M20 + 1 x M16	3 x M6	3,0
	1 x M25 + 1 x M16	3 x M6	3,0
100	1 x M40 + 1 x M16	3 x M8	6,0

Table 5: Terminal box versions

8.4 Main and control connection via combination-mounting-box (customer specific design)

This combination- mounting-box is generally mounted on the end plate on NDE-side. The box is 90 °angulated and contrary to the standard design of the motors not turnable.

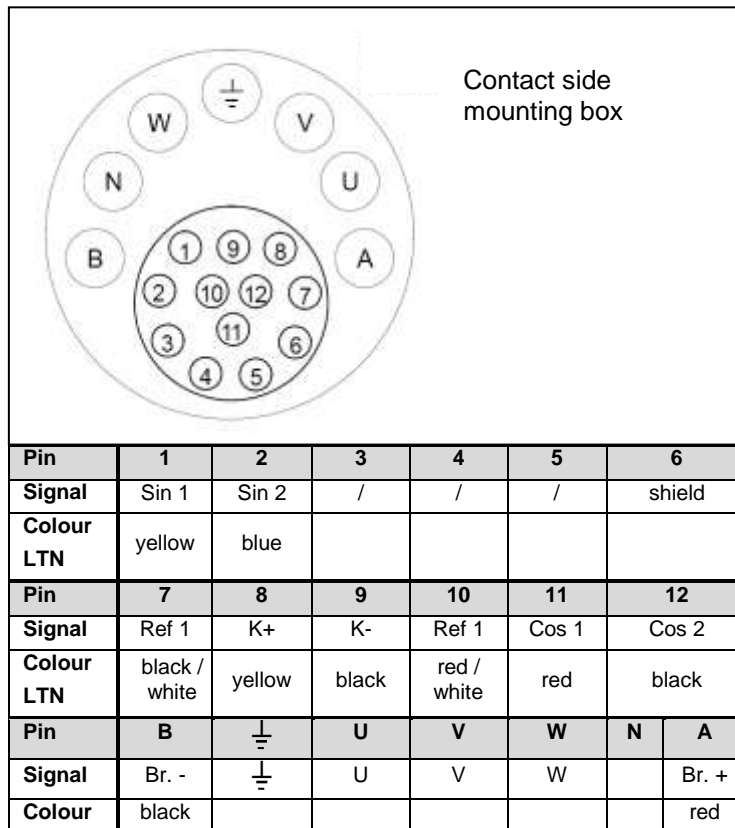

Figure 5: pole assignment of the combination-mounting-box

Outside section: Pin „B to A“ shows the pole assignment for the power terminal and PE-brake.

Inside section: Pin „1 to 12“ shows the pole assignment for resolver and thermal sensor.

8.5 Fan / cooling fan connections via connection socket or terminal box

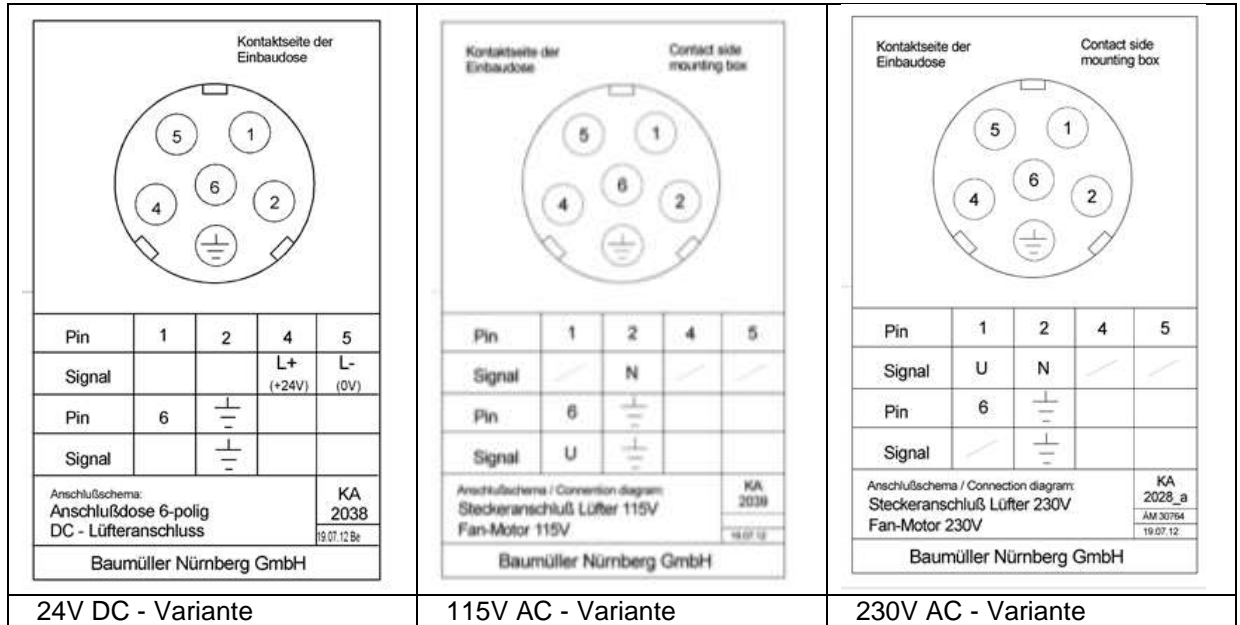

Figure 6A Pole assignment fan connection via a plug (fan at the sizes 56 to 100)

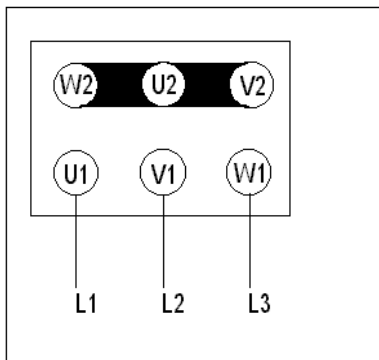

Figure 6B: Terminal assignment fan connection via the terminal box (fan motor at the size 132)

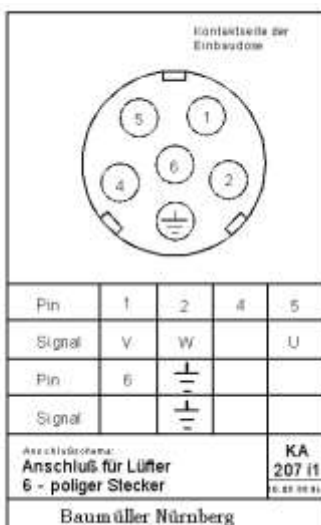

Figure 6C: Pole assignment fan connection via connector (axially integrated fan at a size of 132)

8.6 Control terminal: Resolver

	Pin	Signal	Option for allocation KTY on encoder socket
 <p>View of the contact side of the built-in box</p>	1	cos -	cos -
	2	-	-
	3	-	-
	4	-	-
	5	sin -	sin -
	6	sin +	sin +
	7	-	K - or R2
	8	cos +	cos +
	9	-	K + or R1
	10	ref +	ref +
	11	-	-
	12	ref -	ref -

Figure 7: pole assignment resolver

8.7 Control terminal: SRS / SRM 50

(absolute value encoder with Hiperface terminal of SICK / Stegmann)

	Pin	Signal	Option for allocation KTY on encoder socket
 <p>View of the contact side of the built-in box</p>	1	Cos -	cos -
	2	+ 485	+ 485
	3	-	K + or R1
	4	-	K - or R2
	5	sin +	Sin +
	6	sin -	sin -
	7	- 485	- 485
	8	cos +	cos +
	9	-	-
	10	GND	GND
	11	-	-
	12	+ U	+ U

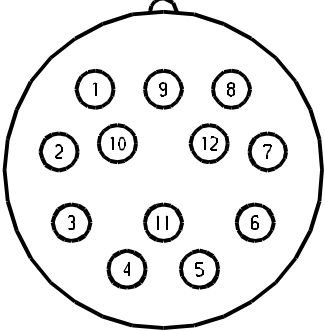
Figure 8: pole assignment SRS / SRM 50

8.8 Control terminal: SEK / SEL 52

(encoder with Hiperface-terminal of SICK / Stegmann)

	Pin	Signal	Option for allocation KTY on encoder socket
 <p>View of the contact side of the built-in box</p>	1	cos -	cos -
	2	+ 485	+ 485
	3	-	K + or R1
	4	-	K - or R2
	5	sin +	sin +
	6	sin -	sin -
	7	- 485	- 485
	8	cos +	cos +
	9	-	-
	10	GND	GND
	11	-	-
	12	+ U	+ U

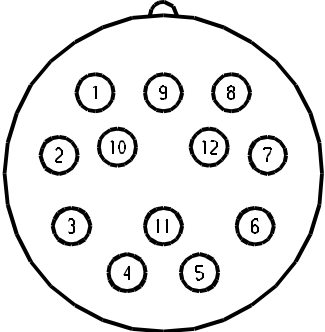
Figure 9: pole assignment SEK/ SEL 52

8.9 Control terminal: ECN 1313 / EQN 1325

(encoder with EnDat 2.1-port of Heidenhain)

	Pin	Signal	Option for allocation KTY on encoder socket
 <p>View of the contact side of the built-in box</p>	1	U_p	U_p
	2	-	-
	3	-	-
	4	0 V	0 V
	5	-	K + or R1
	6	-	K - or R2
	7	U_p	U_p
	8	Clock	Clock
	9	Clock inv.	Clock inv.
	10	0 V	0 V
	11	-	-
	12	B +	B +
	13	B -	B -
	14	Data	Data
	15	A +	A +
	16	A -	A -
	17	Data inv.	Data inv.

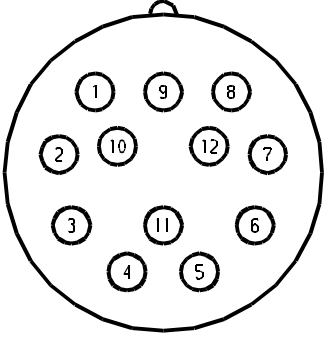
Figure 10: pole assignment ECN 1313 / EQN 1325

8.10 Control terminal: ECN 1325 / EQN 1337 (encoder with EnDat 2.2-port of Heidenhain)

 <p>View of the contact side of the built-in box (M23)</p>	Pin	Signal
	1	Clock
	2	Clock inv.
	3	Up
	4	0 V
	5	Data
	6	Data inv.
	7	Sensor Up
	8	Sensor 0 V
9	-	

Figure 11: pole assignment ECN 1325 / EQN 1337 (M23)

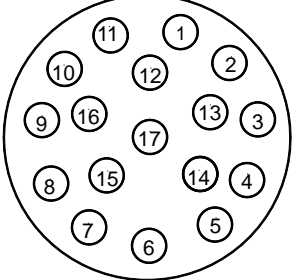
Note:

- For other encoder types and optional lead for the temperature sensor via the encoder cable, see the enclosed wiring diagram or technical documentation for the pin assignment
- The encoder from **Section 8.7 to 8.10** are components susceptible to ESD.
- The technical data contains specifications of the encoder manufacturer for which we assume no liability for the correctness.

8.11 Brake connection at the size 132

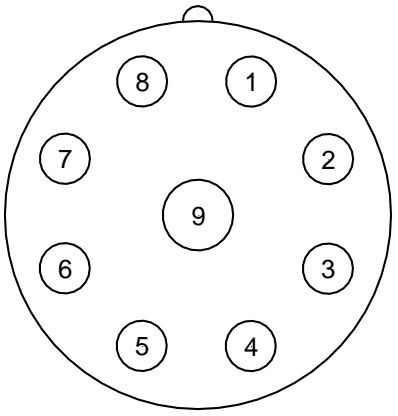
 <table border="1"> <tr> <td>Pin</td> <td>A</td> <td>B</td> <td>C</td> <td>D</td> </tr> <tr> <td>Signal</td> <td>M</td> <td>M</td> <td></td> <td></td> </tr> <tr> <td>Pin</td> <td>1</td> <td>⊥</td> <td>3</td> <td>4</td> </tr> <tr> <td>Signal</td> <td>B</td> <td></td> <td>B</td> <td></td> </tr> </table>	Pin	A	B	C	D	Signal	M	M			Pin	1	⊥	3	4	Signal	B		B		
Pin	A	B	C	D																	
Signal	M	M																			
Pin	1	⊥	3	4																	
Signal	B		B																		
Pole assignment of connector (ventilated motor version)	Terminal assignment at the connection via the brake terminal box (water cooled motor version)																				

Figure 12: Pole and terminal assignment of the brake connection at the motor size 132

9 Appendix 2: water-cooled machines

In addition to the previous chapters for water-cooled motors (EN 60034-6; IC 3W7) the following must be considered complementary:

9.1 Definitions of power ratings for water-cooled machines

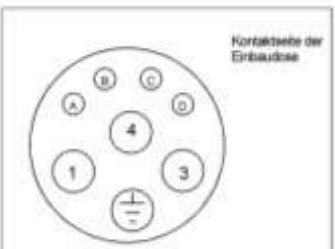
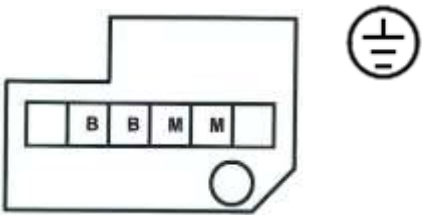
The power ratings (torques) mentioned in the technical product list apply to permanent operation S1 at nominal speed, provided the cooling circuit requirements for water-cooled motors are met!
The reduction factors included in the table below must be considered when operating these motors with higher coolant inlet temperatures:

Coolant inlet temperature	25 °C	30 °C	35 °C	40 °C	45 °C
Percentage of list performance (torque)	100 %	97 %	95 %	92 %	89 %

Table 6: Reduction factors

9.2 Motor cooling

The cooling system of the water-cooled Motors is made of stainless steel or at the sizes 56 and 132 is made of aluminum coated by cathodic dip-coating.

Both of the water connections (inlet and outlet) of the motors are standardly equipped at:

- Size 56 on the B side of the housing with cylindrically threaded holes G/4“.
- The sizes 71 and 100 on the B side of the housing with one smooth stainless steel pipe Ø8 x 1 without additional connection technology.
- Size 132 on the A side of the housing with cylindrically threaded holes G1/2“.

Wetted materials in the motor:

Aluminum coated by cathodic dip-coating at size 56; diversions are of galvanized steel or brass; NBR seals

Size 71 and 100 are made of stainless steel.

Aluminum coated by cathodic dip coating at size 132, connections are of galvanized steel, NBR seals

The cooling system for water-cooled DSD2 motors is made of stainless steel.

The two water connections (inlet and outlet) on the NDE are supplied as standard with a stainless steel tube Ø8 x 1 without extra termination systems.

The coolant (in accordance with the coolant properties specified in **Section 9.6**) is permitted to contain corrosion inhibitors and anti-bacterial additives. The type and volume of these additives is based on the respective manufacturer's recommendations and the prevailing ambient conditions.

	<p>The safety regulations for the product from the manufacturer of the corrosion inhibitors and anti-bacterial additives must be observed.</p> <p>Cooling lubricants employed in the manufacturing process are not allowed to be used to cool the motor!</p> <p>The filling operation of a closed cooling circuit filtering with regard to the harmful deposits in the cooling channels or lines should supposed to be made by filtering at all times (filter fineness <0.1 mm). When having open cooling circuits at all times a filtering should be provided.</p>
---	--

Note: The system manufacturer is responsible for the planning of the cooling circuit. Condensed water must not be allowed to accumulate.

9.3 Instructions for installation

Coolant is supplied and discharged via smooth stainless steel tubes Ø8 x 1 on the B-side of the motors at the sizes 71 and 100. .

A suitable connection to the external cooling circuit can be made for example using John Guest quick connect fittings type SM 040808 S (Ø 8 to Ø 8). Any other connector approved for connecting to smooth stainless steel tubes and capable of withstanding the operating and testing conditions may also be used.

	<p>Cooling circuit connection:</p> <p>The coolant is supplied and discharged via a cylindrical threads at the sizes 56 and 132. In order to avoid housing damages only screw-in glands with cylindrical internal threads as well are supposed to be used.</p> <p>The coolant pipes should not exert compression-tension forces or torsional strain on the motor connections.</p> <p>The connection must be made by specially trained personnel .During this process the motor must disconnected and electrically isolated.</p> <p>When coupling and uncoupling the coolant pipes, make sure that coolant does not enter the motor's terminal box.</p>
---	--

	<p>Leak test acc. to EN 50178:</p> <p>The cooling system is to be checked for leaks before commissioning by pressure testing with coolant (water). The test pressure must be twice the operating pressure (minimum test pressure 1 bar). The coolant used does not have to be brought to operating temperature for this purpose. Pressure must be maintained until all areas have been tested for leaks (minimum test duration 10 minutes).</p>
--	--

9.4 Electrical connections

The standard power connection for water-cooled motors has to be carried out according to the dimensional drawings of the technical documentation.

9.5 Specifications for required coolant volume flows

Motor type	Volume flow in l / min	Pressure decrease $\pm 15\%$ in bar	Heating in K	Max. coolant pressure in bar	Connection(2x) in mm
DSD2-056SO..W	5	0,94	3	6	Internal thread G1/4"
DSD2-056MO..W	5	0,96	4	6	Internal thread G1/4"
DSD2-056LO..W	5	0,98	5	6	Internal thread G1/4"
DSD2-071SO..W	5	0,5	6	6	stainless steel tube $\varnothing 8 \times 1$
DSD2-071MO..W	5	0,65	7	6	stainless steel tube $\varnothing 8 \times 1$
DSD2-071LO..W	5	0,8	8	6	stainless steel tube $\varnothing 8 \times 1$
DSD2-100SO..W	5	0,55	8	6	stainless steel tube $\varnothing 8 \times 1$
DSD2-100MO..W	5	0,65	9	6	stainless steel tube $\varnothing 8 \times 1$
DSD2-100LO..W	5	0,85	10	6	stainless steel tube $\varnothing 8 \times 1$
DSD2-100BO..W	5	1,0	12	6	stainless steel tube $\varnothing 8 \times 1$
DSD2-132KO..W	15	0,35	3	6	Internal thread G1/2"
DSD2-132MO..W	15	0,35	4	6	Internal thread G1/2"
DSD2-132LO..W	15	0,35	4	6	Internal thread G1/2"
DSD2-132BO..W	15	0,35	5	6	Internal thread G1/2"
DSD2-132XO..W	15	0,35	5	6	Internal thread G1/2"
DSD2-132YO..W	15	0,35	6	6	Internal thread G1/2"
DSD2-132YZ..W	15	0,35	6	6	Internal thread G1/2"

Table 7: coolant volume flows

9.6 Coolant consistency

The coolant must satisfy the following specifications:

Conditions	Unit	Value
Maximum permissible system pressure	bar	6
Temperature of coolant- for motor	°C	10 to 25
pH value (at 20 °C)	---	6.5 to 9
Overall hardness	mmol / l	1.43 to 2.5
Chloride - Cl-	mg / l	< 200
Sulfate - SO ₄ ²⁻	mg / l	< 200
Oil	mg / l	< 1
Permissible particle size of solid foreign objects, particles (e.g., sand)	mm	< 0.1

Table 8: Coolant consistency

Clean water that is free of dirt and suspended matter must be used as a coolant.

9.7 Min. coolant temperature against ambient temperature and humidity

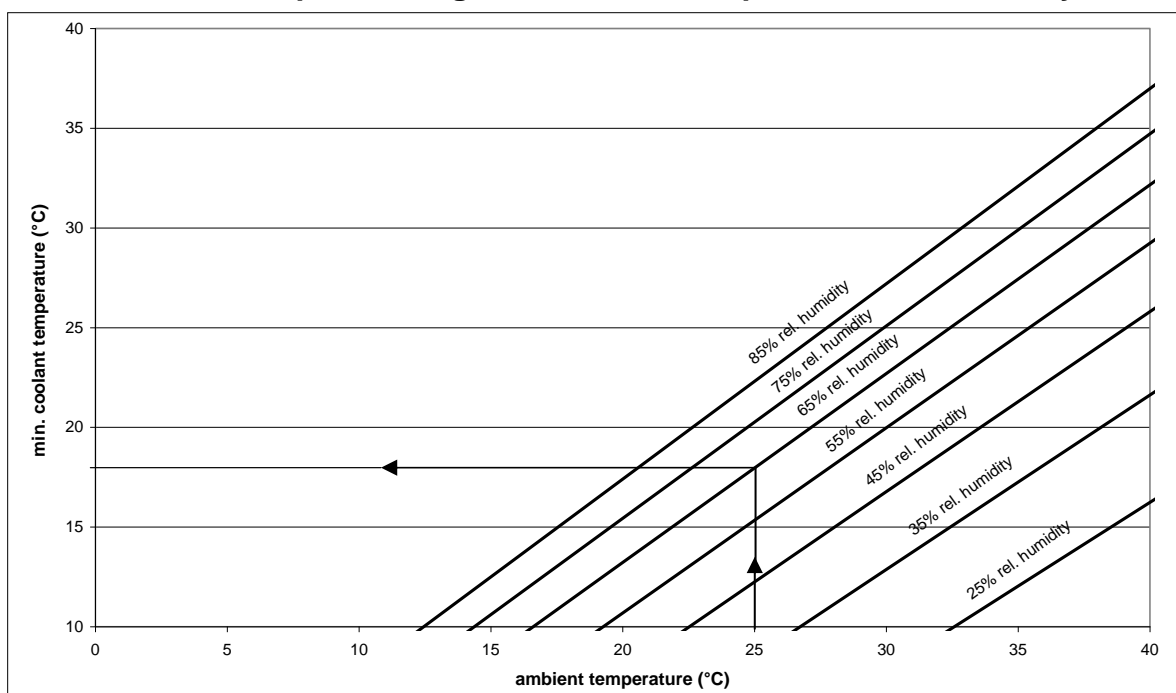

Figure 12: Determination of the coolant temperature

The allowed coolant temperature depends on relative humidity and ambient temperature. For example with an ambient temperature of 25 °C and a relative humidity of 65 % the minimum coolant temperature is

18 °C. Because these are limiting values on practical side a coolant temperature greater than 18 °C should be used. If this minimum coolant temperature will be under run the two- point controller of Baumüller drive must be used to avoid condensation (see **figure 13** on next page).

Note:

For standstill of motor for longer time the cooling must be stopped.(to avoid condensation).
 If ambient temperatures of < 3 °C may occur during a longer motor standstill, coolant should be discharged as a precaution (to prevent frost damage).

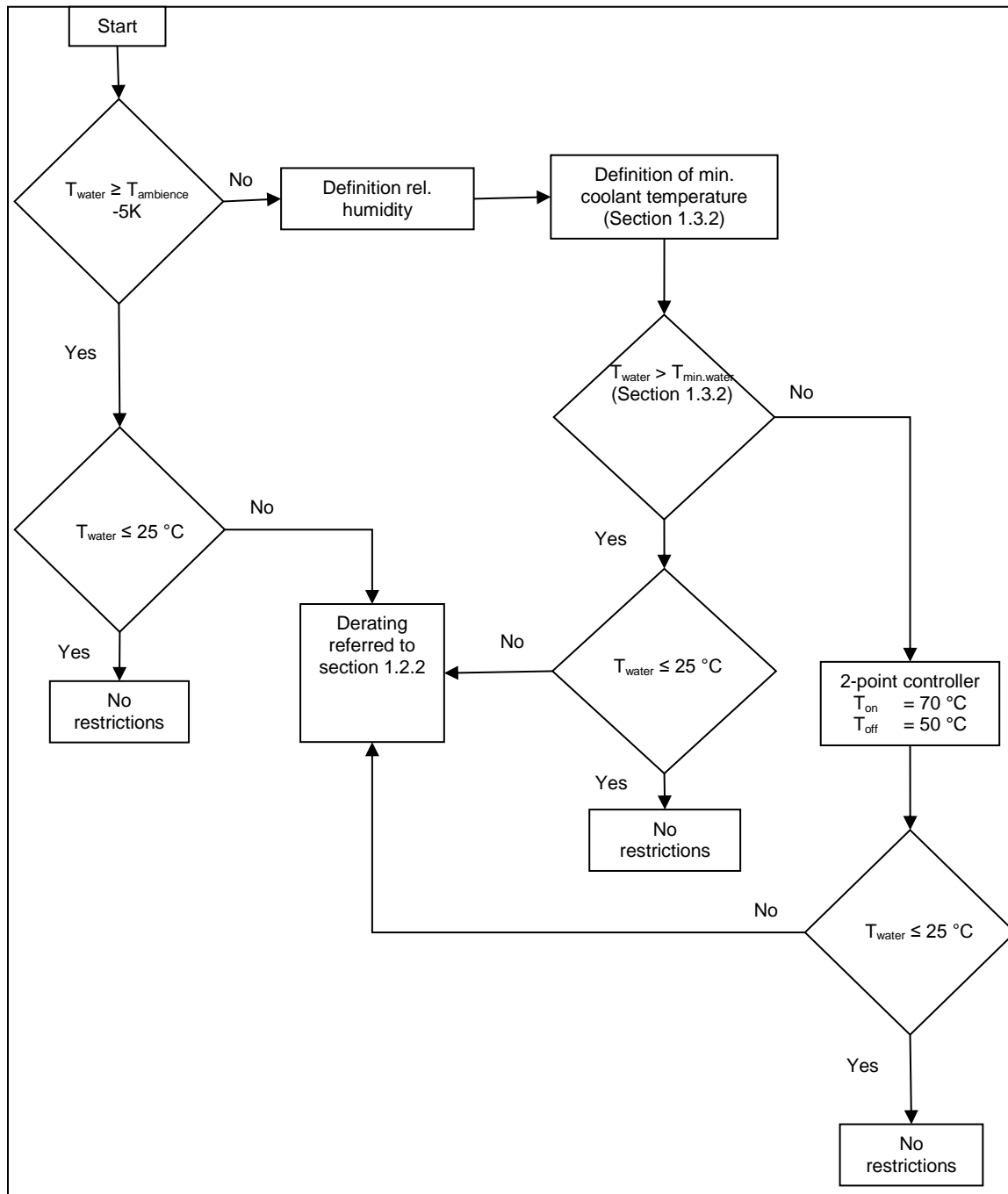

Figure 13: Flow chart coolant temperatur

9.8 Malfunctions in operation

Malfunction	Cause	Remedy
Temperature rise in the motor Motor temperature monitoring unit trips	Water cooling is not active Coolant supply inadequate -Filter extremely dirty - Deposits in the cooling channels - Faults in the external cooling system	Check and switch on if required Check water circuit - Check and clean if required -Check and clean if required - Follow plant supplier's instructions
Overpressure in the cooling system	Heavily soiled coolant Cooling channels blocked Malfunctions in the external cooling system	Filter coolant Check and clean if required Follow plant supplier's instructions

Table 9: Malfunctions water cooling

9.9 Inspection

During regular cleaning the flow rate and the pressure ratio of the cooling system must be checked.

Warranty and liability

All the details in this documentation are non-binding customer information and subject to on going change and will be constantly updated by our editing staff. Warranty and liability claims against Baumüller Nürnberg GmbH are excluded if, in particular, damage is caused by one or more of the following:

- You have not followed the instructions in this documentation.
- You have not used the system for the purpose intended.
- You have
 - installed, connected, started or operated the machine incorrectly or have not maintained it.
 - permitted the system to be mounted, connected, commissioned, operated, and/or maintained by unqualified or insufficiently qualified personnel.
 - overloaded the system.
 - operated the system with
 - faulty safety devices,
 - safety devices that were incorrectly fitted or not fitted,
 - safety devices or protective devices that are not in working order.
 - not operated the system in the stipulated ambient conditions.
- You have modified the system without the written approval of Baumüller Nürnberg GmbH.
- You have not observed the instructions concerning maintenance in the component descriptions.
- You have not monitored parts that are subject to wear sufficiently.
- You have performed a repair incorrectly.
- You have combined the system with products from other manufacturers in an improper manner.
- You have combined the drive system with faulty and/or incorrectly documented products from another manufacturer.

The latest version of the General Terms and Conditions of Sale of Baumüller Nürnberg GmbH always apply. These will be made available to you at the latest on conclusion of the contract.